

WISENET

High Resolution Box Camera

User Manual

HCB-6001



High Resolution Box Camera

User Manual

Copyright

©2017 Hanwha Techwin Co., Ltd. All rights reserved.

Trademark

Each of trademarks herein is registered. The name of this product and other trademarks mentioned in this manual are the registered trademark of their respective company.

Restriction

Copyright of this document is reserved. Under no circumstances, this document shall be reproduced, distributed or changed, partially or wholly, without formal authorization.

Disclaimer

Hanwha Techwin makes the best to verify the integrity and correctness of the contents in this document, but no formal guarantee shall be provided. Use of this document and the subsequent results shall be entirely on the user's own responsibility. Hanwha Techwin reserves the right to change the contents of this document without prior notice.

❖ Design and specifications are subject to change without prior notice.

Before operating the camera, confirm the camera model and correct input power voltage.
To help you understand this manual thoroughly, we'll introduce our model description.

■ HCB-6001 SERIES

- NTSC MODEL
HCB-6001N
- PAL MODEL
HCB-6001P

■ MODEL DESCRIPTION

- HCB-6001X



- SIGNAL SYSTEM
N → NTSC MODEL
P → PAL MODEL

safety information



CAUTION
RISK OF ELECTRIC SHOCK.
DO NOT OPEN



CAUTION: TO REDUCE THE RISK OF ELECTRIC SHOCK, DO NOT REMOVE COVER (OR BACK) NO USER SERVICEABLE PARTS INSIDE. REFER SERVICING TO QUALIFIED SERVICE PERSONNEL.



This symbol indicates that dangerous voltage consisting a risk of electric shock is present within this unit.



This exclamation point symbol is intended to alert the user to the presence of important operating and maintenance (servicing) instructions in the literature accompanying the appliance.

WARNING

- To prevent damage which may result in fire or electric shock hazard, do not expose this appliance to rain or moisture.
- To prevent injury, this apparatus must be securely attached to the floor/wall in accordance with the installation instructions.

WARNING

1. Be sure to use only the standard adapter that is specified in the specification sheet. Using any other adapter could cause fire, electrical shock, or damage to the product.
2. Incorrectly connecting the power supply or replacing battery may cause explosion, fire, electric shock, or damage to the product.
3. Do not connect multiple cameras to a single adapter. Exceeding the capacity may cause abnormal heat generation or fire.
4. Securely plug the power cord into the power receptacle. insecure connection may cause fire.
5. When installing the camera, fasten it securely and firmly. The fall of camera may cause personal injury.

6. Do not place conductive objects (e.g. screwdrivers, coins, metal parts, etc.) or containers filled with water on top of the camera. doing so may cause personal injury due to fire, electric shock, or falling objects.
7. Do not install the unit in humid, dusty, or sooty locations. doing so may cause fire or electric shock.
8. If any unusual smells or smoke come from the unit, stop using the product. in such case, immediately disconnect the power source and contact the service center. continued use in such a condition may cause fire or electric shock.
9. If this product fails to operate normally, contact the nearest service center. never disassemble or modify this product in any way. (samsung is not liable for problems caused by unauthorized modifications or attempted repair.)
10. When cleaning, do not spray water directly onto parts of the product. doing so may cause fire or electric shock.

CAUTION

1. Do not drop objects on the product or apply strong shock to it. Keep away from a location subject to excessive vibration or magnetic interference.
2. Do not install in a location subject to high temperature (over 55°C), low temperature (below -10°C), or high humidity. Doing so may cause fire or electric shock.
3. If you want to relocate the already installed product, be sure to turn off the power and then move or reinstall it.
4. Remove the power plug from the outlet when there is a lightning. Neglecting to do so may cause fire or damage to the product.
5. Keep out of direct sunlight and heat radiation sources. It may cause fire.
6. Install it in a place with good ventilation.
7. Avoid aiming the camera directly towards extremely bright objects such as sun, as this may damage the CMOS image sensor.
8. Apparatus shall not be exposed to dripping or splashing and no objects filled with liquids, such as vases, shall be placed on the apparatus.
9. The Mains plug is used as a disconnect device and shall stay readily operable at any time
10. Do not expose the camera to radioactivity. Radioactivity exposure may damage the CMOS.

safety information

FCC Statement

This device complies with part 15 of the FCC Rules. Operation is subject to the following two conditions :

- 1) This device may not cause harmful interference, and
- 2) This device must accept any interference received including interference that may cause undesired operation.

CAUTION

This equipment has been tested and found to comply with the limits for a Class A digital device, pursuant to part 15 of FCC Rules. These limits are designed to provide reasonable protection against harmful interference when the equipment is operated in a commercial environment. This equipment generates, uses, and can radiate radio frequency energy and, if not installed and used in accordance with the instruction manual, may cause harmful interference to radio communications. Operation of this equipment in a residential area is likely to cause harmful interference in which case the user will be required to correct the interference at his own expense.



IC Compliance Notice

This Class A digital apparatus meets all requirements of the Canadian Interference-Causing Equipment Regulations of ICES-003.



Correct Disposal of This Product (Waste Electrical & Electronic Equipment)

(Applicable in the European Union and other European countries with separate collection systems)

This marking on the product, accessories or literature indicates that the product and its electronic accessories (e.g. charger, headset, USB cable) should not be disposed of with other household waste at the end of their working life. To prevent possible harm to the environment or human health from uncontrolled waste disposal, please separate these items from other types of waste and recycle them responsibly to promote the sustainable reuse of material resources.

Household users should contact either the retailer where they purchased this product, or their local government office, for details of where and how they can take these items for environmentally safe recycling.

Business users should contact their supplier and check the terms and conditions of the purchase contract. This product and its electronic accessories should not be mixed with other commercial wastes for disposal.



Correct disposal of batteries in this product

(Applicable in the European Union and other European countries with separate battery return systems.)

This marking on the battery, manual or packaging indicates that the batteries in this product should not be disposed of with other household waste at the end of their working life. Where marked, the chemical symbols Hg, Cd or Pb indicate that the battery contains mercury, cadmium or lead above the reference levels in EC Directive 2006/66. If batteries are not properly disposed of, these substances can cause harm to human health or the environment.

To protect natural resources and to promote material reuse, please separate batteries from other types of waste and recycle them through your local, free battery return system.

important safety instructions

1. Read these instructions.
2. Keep these instructions.
3. Heed all warnings.
4. Follow all instructions.
5. Do not use this apparatus near water.
6. Clean only with dry cloth.
7. Do not block any ventilation openings. Install in accordance with the manufacturer's instructions.
8. Do not install near any heat sources such as radiators, heat registers, or other apparatus (including amplifiers) that produce heat.
9. Do not defeat the safety purpose of the polarized or grounding-type plug. A polarized plug has two blades with one wider than the other. A grounding type plug has two blades and a third grounding prong. The wide blade or the third prong is provided for your safety. If the provided plug does not fit into your outlet, consult an electrician for replacement of the obsolete outlet.
10. Protect the power cord from being walked on or pinched particularly at plugs, convenience receptacles, and the point where they exit from the apparatus.
11. Only use attachments/accessories specified by the manufacturer.
12. Use only with cart, stand, tripod, bracket, or table specified by the manufacturer, or sold with the apparatus.
13. Unplug this apparatus when a card is used. Use caution when moving the cart/ apparatus combination to avoid injury from tip-over.
14. Refer all servicing to qualified service personnel. Servicing is required when the apparatus has been damaged in any way, such as powersupply cord or plug is damaged, liquid has been spilled or objects have fallen into the apparatus, the apparatus has been exposed to rain or moisture, does not operate normally, or has been dropped.
15. This product is intended to be supplied by a Listed Power Supply Unit marked "Class 2" or "LPS" and rated from 24 Vac (50/60 Hz) min.0.6 A or 12 Vdc, min.0.6A.
16. If you use excessive force when installing the product, the camera may be damaged and malfunction.
If you forcibly install the product using non-compliant tools, the product may be damaged.

safety information

17. Do not install the product in a place where chemical substances or oil mist exists or may be generated. As edible oils such as soybean oil may damage or warp the product, do not install the product in the kitchen or near the kitchen table.
This may cause damage to the product.
18. When installing the product, be careful not to allow the surface of the product to be stained with chemical substance.
Some chemical solvents such as cleaner or adhesives may cause serious damage to the product's surface.
19. If you install/disassemble the product in a manner that has not been recommended, the production functions/performance may not be guaranteed.
Install the product by referring to "Installation & connection" in the user manual.
20. Installing or using the product in water can cause serious damage to the product.



Apparatus shall not be exposed to dripping or splashing and no objects filled with liquids, such as vases, shall be placed on the apparatus



Hanwha Techwin cares for the environment at all product manufacturing stages, and is taking measures to provide customers with more environmentally friendly products.

The Eco mark represents Hanwha Techwin's devotion to creating environmentally friendly products, and indicates that the product satisfies the EU RoHS Directive.

contents

INTRODUCTION	10	Features
	11	Components and Accessories
	12	Overview
	14	Lens
CONNECTION	17	Connecting to Monitor
	17	Connecting to Power
	18	Control via RS-485 Interface
	19	Using Coaxial Communications
CAMERA OPERATION	20	Menu Configuration
	20	Menu Setup
TROUBLESHOOTING	34	Troubleshooting
SPECIFICATIONS	35	Specifications
	37	Dimension

introduction

FEATURES

- **High Resolution**

Use of a 2 mega pixel CMOS device provides clear pictures with a horizontal resolution of 1000.

- **Excellent Sensitivity**

The built-in high sensitivity COLOR CMOS produces a clear image.

- Color: 0.15Lux(F1.2)

B/W: 0.09Lux(F1.2)

- **SSNR4 (Samsung Super Noise Reduction) Function**

High performance DSP Chip removes noises of GAIN resulting from the low light level and shows a vivid, high definition video even in the dark place.

- **Day&Night**

This camera has a function that automatically selects the mode that is appropriate for daytime or night-time conditions. The COLOR mode operates in daytime conditions to provide optimum colors, and B/W mode operates in night-time conditions to enhance the definition of the image.

- **PROFILE**

You can set a mode according to the camera installation conditions.

- BASIC, DAYNIGHT, BACKLIGHT, ITS, INDOOR, USER

- **D-WDR**

If an object has a large variance between bright and dark areas, it will keep bright areas bright and make selected dark areas bright, so that the overall brightness can be maintained.

- **WDR**

By adopting a proprietary high performance DSP chip, the camera delivers clear, high quality pictures even in backlight, by increasing exposure in dark areas while decreasing it in bright areas; a corrected image with clear details results.

- **DC Drive Lens Support**

You can select Manual or DC Drive Lens from the menu.

- **Miscellaneous Functions**

HLC(High Light Compensation), REVERSE , SHARPNESS and PRIVACY functions are provided.

- **SIMPLE FOCUS**

Using SIMPLE FOCUS, you can easily adjust the focus.

- **Communication**

Coaxial and RS-485 communication methods are supported.

- Coaxial Communications: ACP(AHD Coax Protocol), TCP(TVI Coax Protocol), CCP(CVI Coax Protocol), COAX-C(CVBS Coax Protocol)

- RS-485 Communications : SAMSUNG-T/SAMSUNG-E/PELCO-D/PELCO-P/BOSCH/HONEYWELL

- **OSD**

The camera's OSD is complimented by 16 languages.

- English, Japanese, Spanish, French, Portuguese, Korean, German, Italian, Russian, Polish, Czech, Romanian, Serbian, Swedish, Danish, Turkish.

COMPONENTS AND ACCESSORIES

Check if the following items are included in the product package.

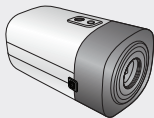

HCB-6001



Quick Manual

introduction

OVERVIEW

Front View

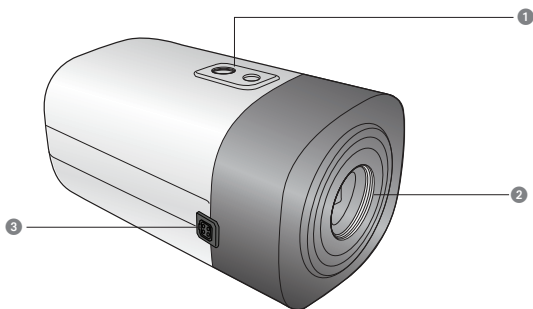

1 Tripod Mounting Bracket Screw Hole :

- Used to fix the camera on a bracket.
The screw sizes for this hole are as follows.
1/4"-20 UNC (20 THREAD)
L:4.5mm±0.2mm (ISO standard), or 0.197"
(ASA standard)

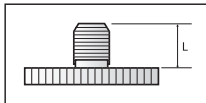

2 Lens adaptor : Install this if you use the lens.

3 Auto Iris Lens Connector : Used to connect Auto Iris Lens plug.



- Auto shutter adaptor, c-mount adaptor and supporting board are not provided with the camera.
Please check the installed documentation of tripod for the installation of cameras.

Rear View

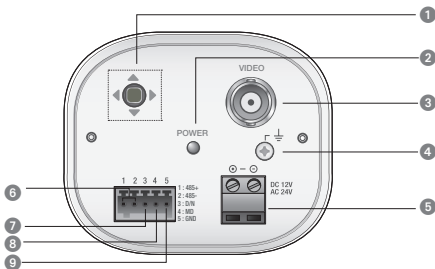

1 Function Setup switch

Press the function setting button briefly to display the menu screen.

After the menu is displayed on the screen, move the cursor <up/down/left/right> to select the desired item or to change the value or status.

Also, pressing the function setting button for 2~5 seconds will enable the simple focus function, And pressing and holding it for 5 seconds will change the VIDEO FORMAT setting.

2 Power LED : This lamp is lit when the camera is receiving power normally.

3 Video OUT Terminal : Sends video signal and connects to the Video IN port of a AHD DVR.

4 Ground terminal

5 Power input terminal : Connect the designated power supplies.

6 RS-485 Control Port : You can control SETUP MENU through this port by using external controllers like a Remote controller that RS-485 Communication is supported.

7 D & N Input Port : You can switch to Day & Night Mode by connecting an external signal to this port.

8 MD Output Port : Motion detection signals are output through this port.

9 GND

※ External I / O port configuration

Num	Name	I/O Direction
1	RS-485+	I/O
2	RS-485-	I/O
3	DN	I
4	MD	O
5	GND	-

introduction

LENS

The lens is not supplied with this camera. Purchase a lens suitable for your environment. This camera accepts the auto iris lens and both C-and CS-mount lens.



- To use the functions of this camera effectively it is recommended that a DC type Auto Iris lens is used.
- Keep the lens surface clean, if it becomes contaminated with dirt or fingerprints the picture quality suffers.

When Using Auto Iris Lens

1. Remove the protective glass cover from the front of the camera, and fasten the auto iris lens by turning it clockwise.
2. After combining the lens, adjust the focus.

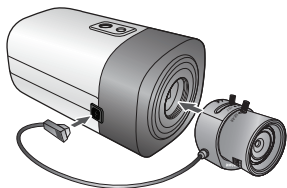

When Using a C/CS-Mount lens (Sold separately)

Before installing a lens, identify whether the lens to be installed is a C-Mount or CS-Mount. This camera is set for a CS-Mount Lens by default. To install a C-Mount Lens, a simple modification is required.

- **When Using a CS-Mount Lens**

Remove the protective glass cover at the front of this product and turn the CS-Mount Lens clockwise to install it.

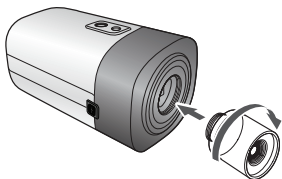

- Use the lens connector shown in the following figure. If the dimensions of the connector are not correct, it may damage the camera, or the lens may not be installed firmly.
- If the lens is too heavy, the camera becomes unbalanced and there may be problems. Use a lens that weighs less than 450g.
- When adjusting the Automatic Level Control (ALC) of an auto iris lens, use Av mode if available. If you use the Pk mode, the picture brightness may change continuously.

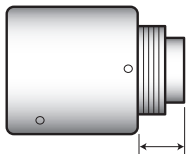

C-Mount Lens: 10mm or less
CS-Mount Lens: 5mm or less

introduction

- **When Using a C-Mount Lens**

1. Remove the protective glass cover at the front of this product and turn the C-Mount Adapter clockwise to install it.

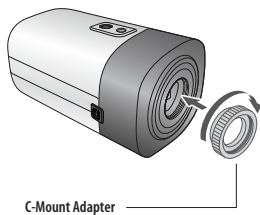

2. Turn the C-Mount lens clockwise to install it.

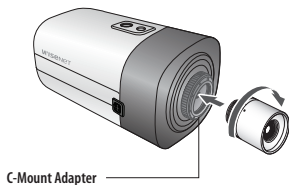

3. After combining the lens, adjust the focus.

connection

CONNECTING TO MONITOR

Refer to the following figure to connect monitors through DVR.

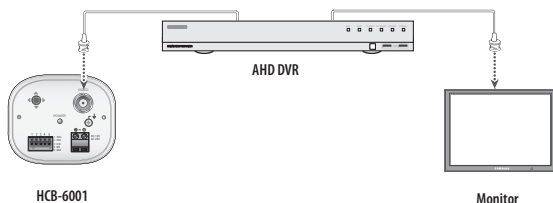

- As the connecting method varies with the instruments, refer to the manual supplied with the instrument.
- Only connect the cable when the power is turned off.



- HCB-6001 supports four video output format, including AHD, CVBS, TVI and CVI. Default setting is AHD. Please connect camera with proper DVR accordingly.

CONNECTING TO POWER

You can connect power as shown in the following figure.

Since the power specification supports both AC and DC, connect AC 24V, 500mA Adaptor or DC 12V, 500mA Adaptor.

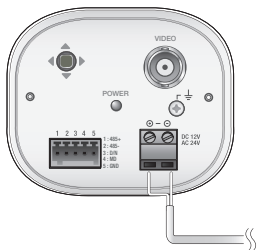

connection

When the resistance value of copper wire is at [20°C(68°F)]

Copper wire size (AWG)	#24 (0.22mm ²)	#22 (0.33mm ²)	#20 (0.52mm ²)	#18 (0.83mm ²)
Resistance value(Ω/m)	0.078	0.050	0.030	0.018
Voltage Drop (V/m)	0.028	0.018	0.011	0.006

- As shown in the table above, voltage decreases as the wire gets longer.
Therefore use of an excessively long adaptor output line for connection to the camera may affect the performance of the camera.
- × Standard voltage for camera operation : DC 12V±10%, AC 24V±10%
- × There may be some deviation in voltage drop depending on the type of wire and the manufacturer.



- Be sure to connect power only after all the installation is complete.

CONTROL VIA RS-485 INTERFACE

The camera can be controlled by using external controllers like a Remote controller. (RS-485 Communication)

(1) To control by PC

Connect the RS-485 control port of the camera and the serial cable through an RS-485 converter.

Example) PC Serial Port → Serial Cable → RS-485 Converter → Camera RS-485 Control Port.

(2) To control using a DVR or System Controller

Connect the RS-485 cable (TRX+, TRX-) to the connection port of the 485 control board that is connected to the DVR or System Controller.

485 Control Board Connection Port	RS-485 Control Port
(+) CONNECTION TERMINAL (TRX+)	485+
(-) CONNECTION TERMINAL (TRX-)	485-

* RS-485 Communication establishment initial value

Item	Camera ID	BAUD RATE	UART MODE	RET PKT
Initial value	1	9600	8-NONE-1	ENABLE



- To control the camera by constructing an additional controller, use the SAMSUNG-T/ SAMSUNG-E/PELCO-D/PELCO-P/BOSCH/HONEYWELL protocol.

USING COAXIAL COMMUNICATIONS

- Coaxial Communications System
- OSD Control method

CAMERA	DVR	CONTROLLER
SET	MENU/ENTER	OSD KEY
UP	UP KEY	JOYSTICK UP
DOWN	DOWN KEY	JOYSTICK DOWN
LEFT	LEFT KEY	JOYSTICK LEFT
RIGHT	RIGHT KEY	JOYSTICK RIGHT

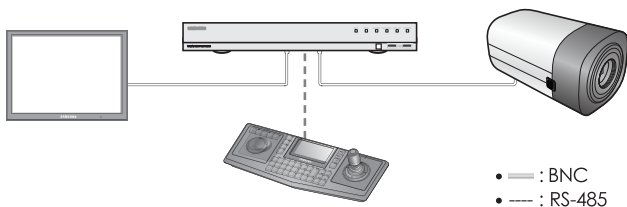

- Video Cable

The camera's video output port is connected to the monitor with a BNC coaxial cable, shown below.

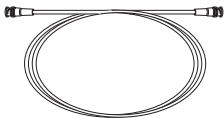

Distance	Recommended Cable Specification
300m	3C2V Coaxial Cable
500m	5C2V Coaxial Cable



- It is recommended that pure copper coax cable is used and not copper coated steel, as this will cause issues with the communication over the coaxial cable.

camera operation

MENU CONFIGURATION

MAIN SETUP			
VIDEO FORMAT	<ul style="list-style-type: none">• AHD• TVI	<ul style="list-style-type: none">• CVBS	<ul style="list-style-type: none">• CVI
PROFILE	<ul style="list-style-type: none">• BASIC• ITS	<ul style="list-style-type: none">• DAY/NIGHT• INDOOR	<ul style="list-style-type: none">• BACKLIGHT• USER
D-WDR	<ul style="list-style-type: none">• ON	<ul style="list-style-type: none">• OFF	
WHITE BAL	<ul style="list-style-type: none">• ATW• MANUAL	<ul style="list-style-type: none">• OUTDOOR• AWC → SET	<ul style="list-style-type: none">• INDOOR
EXPOSURE	<ul style="list-style-type: none">• BRIGHTNESS• AGC	<ul style="list-style-type: none">• LENS• SSNR4	<ul style="list-style-type: none">• SHUTTER• RETURN
BACKLIGHT	<ul style="list-style-type: none">• OFF• WDR	<ul style="list-style-type: none">• USER BLC	<ul style="list-style-type: none">• HLC
SPECIAL	<ul style="list-style-type: none">• DISPLAY• DAY/NIGHT• MOTION	<ul style="list-style-type: none">• COMM ADJ• DEFOG• RETURN	<ul style="list-style-type: none">• IMAGE ADJ• PRIVACY
SIMPLE FOCUS	<ul style="list-style-type: none">• SIMPLE FOCUS• AFTER D/N	<ul style="list-style-type: none">• FOCUS INIT• RETURN	<ul style="list-style-type: none">• MANUAL
EXIT	<ul style="list-style-type: none">• SAVE	<ul style="list-style-type: none">• NOT SAVE	<ul style="list-style-type: none">• RESET

MENU SETUP

Use the Function Setup switch within the camera.

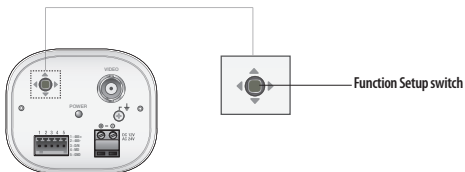

- Holding Function Setup button 2 to 4.9 seconds, simple focus would be performed.
- Holding SETUP key over 5 seconds, It will switch Video format from AHD ,TVI, CVI to CVBS. If current Video format is CVBS, holding SETUP key for over 5 seconds, It will be switched to AHD.

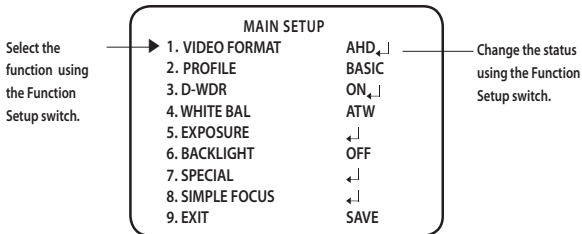

- Press the Function Setup switch.
 - Main SETUP menu is displayed on the monitor screen.
- Select a desired function using the Function Setup switch.
 - Place the cursor over a desired item.
- Set up a selected item by using the Function Setup switch.
- To finish the setting, select 'EXIT' and press the Function Setup switch.



- An item with the ◀ icon also has sub menus. To select a sub menu, select an item with the icon and press the Function Setup switch.
- An item with the --- icon is unavailable due to function settings.

VIDEO FORMAT

- When the SETUP menu screen is displayed, select 'VIDEO FORMAT' by using the Function Setup switch so that the arrow indicates 'VIDEO FORMAT'.
- Select a desired mode using the Function Setup switch.
 - The video output can be selected from AHD/CVBS/CVI/TVI.

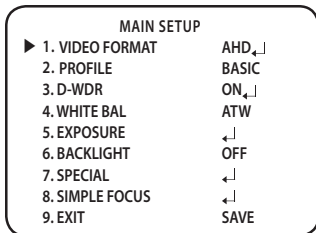

- By pressing the function setting button for more than 5 seconds, you can change the setting from AHD, TVI, and CVI to CVBS. From CVBS, you can change it to AHD.

camera operation

PROFILE

- When the SETUP menu screen is displayed, select 'PROFILE' by using the Function Setup switch so that the arrow indicates 'PROFILE'.
- Select a desired mode using the Function Setup switch according to the picture display you want.

MAIN SETUP	
1. VIDEO FORMAT	AHD _↓
▶ 2. PROFILE	BASIC
3. D-WDR	ON _↓
4. WHITE BAL	ATW
5. EXPOSURE	↓
6. BACKLIGHT	OFF
7. SPECIAL	↓
8. SIMPLE FOCUS	↓
9. EXIT	SAVE

- **BASIC** : The most common environment is set to meet.
 - **DAY/NIGHT** : It will be set automatically so it optimizes to the day or night conditions, respectively.
 - **BACKLIGHT** : It will be set automatically so you can distinguish the object from the background in a severe backlighting scene.
 - **ITS** : It will be set automatically so you can easily check the traffic conditions.
 - **INDOOR** : It will be set automatically to help you take a picture in a regular indoor lighting condition.
 - **USER** : Automatically configures the camera to your custom settings.
 - 1) Select Custom for Simple Setup mode.
 - 2) Configure the menu options to your custom settings.
 - 3) The settings are automatically saved as Custom mode.
 - 4) Profile user mode don't initialize when menu resets.
- In the PROFILE menu, you can configure the following camera settings at once.

	BASIC	DAY/NIGHT	BACKLIGHT	ITS	INDOOR	USER
SHUTTER	1/5~1/12000	1/5~1/12000	1/5~1/12000	1/200~1/12000	A.FLK	-
AGC	HIGH	HIGH	HIGH	HIGH	HIGH	-
WHITE BAL	ATW	ATW	ATW	INDOOR	INDOOR	-
BACKLIGHT	OFF	OFF	USER BLC	OFF	OFF	-
SSNR4	ON	ON	ON	ON	ON	-
DAY/NIGHT	AUTO	AUTO	AUTO	AUTO	AUTO	-



- If you select ITS mode, the shutter will be set to 1/200 sec. Noise can be detected at night.

D-WDR

If an object has a large variance between bright and dark areas, it will keep bright areas bright and make selected dark areas bright, so that the overall brightness can be maintained.

- When the SETUP menu screen is displayed, select 'D-WDR' by using the Function Setup switch so that the arrow indicates 'D-WDR'.
- Use the Function Setup switch to change the D-WDR level in the sub menu according to the contrast between bright and dark areas.

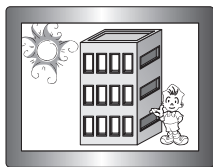

<D-WDR ON>

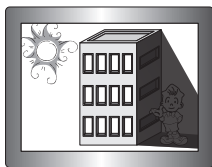

<D-WDR OFF>

White Bal (White Balance)

Use the White Balance function to adjust the screen color.

- When the SETUP menu screen is displayed, select 'White Bal' by using the Function Setup switch so that the arrow indicates 'White Bal'.
- Select a desired mode using the Function Setup switch.

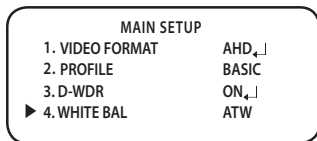

✗ Select one of the following 5 modes, as appropriate for your purpose.

- **ATW**: Select this when the color temperature is between 1,800K and 10,500K.
- **OUTDOOR**: Use it in a color temperature range of 1,800K to 10,500K.(including Natrium). Auto adjustment is made to optimize the camera color to the outdoor environment.
- **INDOOR**: Select this when the color temperature is between 4,500K and 8,500K. Automatically adjusts the camera color for optimization to the indoor environment.

camera operation

- **MANUAL** : Select this to fine-tune White Balance manually. Set White Balance first by using the ATW or AWC mode. After that button to MANUAL mode, fine-tune the White Balance and the Function Setup switch.

WB MANUAL		
▶ 1. RED GAIN		147
2. BLUE GAIN		124
3. RETURN	←	

- **AWC→SET** : To find the optimal luminance level for the current environment, point the camera towards a sheet of white paper and press the Function Setup switch. If the environment changes, readjust it.





- White Balance may not work properly under the following conditions. In this case select the AWC mode.
 - 1 Select this When the color temperature of environment surrounding the subject is out of the control range (e.g. clear sky, or sunset)
 - 2 When the ambient illumination of the subject is dim.
- If the camera is directed towards a fluorescent light or is installed in a place where illumination changes dramatically, the White Balance operation may become unstable.

EXPOSURE

1. When the SETUP menu screen is displayed, select 'EXPOSURE' by using the Function Setup switch so that the arrow indicates 'EXPOSURE'.
2. Select a desired mode using the Function Setup switch.

EXPOSURE SETUP		
▶ 1. BRIGHTNESS		50
2. LENS	DC	←
3. SHUTTER	←	
4. AGC	HIGH	
5. SSNR4	ON	←
6. RETURN	←	

- **BRIGHTNESS** : Adjusts the video brightness.
- **LENS** : Using this function, you can control the screen brightness.
 - DC : Select Auto Iris Lens.
 - IRIS SPEED (DC) : Adjusts the Iris control speed of the DC lens. If the control speed is too slow or fast, please use this menu to adjust the speed.
 - FOCUS ADJ (DC) : To correctly adjust the focus of LENS, activate the focus setup mode located at the bottom of each lens menu.
 - Manual : The shutter does not automatically move but is fixed to the maximal degree in this mode.

-  ■ Some lenses may not work properly, depending on the setting of the BRIGHTNESS LEVEL.
 - **SHUTTER** : You can select the shutter.
 - MIN : 1 ~ 1/12000
 - MAX : 1/60 ~ 1/12000(NTSC) , 1/50 ~ 1/12000(PAL)
 - A.FLK : Select this when you experience picture flicker, this happen when there is a clash with the installed lighting frequency.
-  ■ The greater the shutter value the brighter the screen is but the more the residual images of objects there are.
 - If the min shutter value is large, it can cause noise, spots and white areas but still operate normally.
 - If you do not use the AGC mode on the exposure menu, it cannot be set above 1/60sec.
 - Depending on the setting range of the minimal/maximal shutter, the screen exposure can become saturated.
- **AGC (OFF/LOW/MIDDLE/HIGH/VERY HIGH)** : The higher the gain level, the brighter the screen - but the greater the noise.
- **SSNR4** : This function reduces the background noise in a low luminance environment.
 - OFF : Deactivates SSNR4. Noise is not reduced.
 - ON : Activates SSNR4 so that noise is reduced.
-  ■ When adjusting the noise reduction level in the SSNR4 mode, remember that the higher the level set, the more the noise level will be reduced, as will the brightness of the image.

BACKLIGHT

The camera uses high performance DSP chips that are designed to clearly display the object and the background despite severe reverse light.

1. When the SETUP menu screen is displayed, select 'BACKLIGHT' by using the Function Setup switch. so that the arrow indicates 'BACKLIGHT'.
2. Select a desired mode using the Function Setup switch depending on the camera purpose.

camera operation

- **USER BLC :**

Enables a user to select a desired area on a picture and view that area more clearly.

- LEVEL : Adjusts the brightness level of a monitoring area.
- TOP/BOTTOM/LEFT/RIGHT : Adjust the area to be enhanced.
- RETURN : Return to the MAIN SETUP menu.

BLC SETUP		
▶ 1.LEVEL	MIDDLE	
2.TOP		3
3.BOTTOM		7
4.LEFT		3
5.RIGHT		7
6.RETURN	↵	

- **HLC (High Light Compensation) :**

This function masks the strong light to minimize white out due to over exposure and preserve much of the on-screen details when the camera aims a strong light source.

- LEVEL : Adjusts the brightness level of a monitoring area.
- LIMIT : Enable to change the operating condition.
- TOP/BOTTOM/LEFT/RIGHT : Adjust the area to be enhanced.
- RETURN : Return to the MAIN SETUP menu.

HLC SETUP		
▶ 1.LEVEL	MIDDLE	
1.LIMIT	NIGHT ONLY	
2.TOP		3
3.BOTTOM		5
4.LEFT		3
5.RIGHT		5
6.RETURN	↵	

- **WDR**

When there are both bright and dark areas at the same time, this mode makes both areas distinctive.

- LEVEL : Select one from low, med, high to adjust the brightness of the WDR setup.

WDR SETUP	
▶ 1.LEVEL	MIDDLE
2.RETURN	↵



<WDR ON>

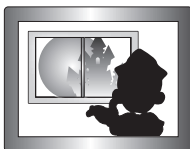

<WDR OFF>

- RETURN : Return to the MAIN SETUP menu.



- If the white balance menu is set to manual, then HLC performance can be limited.
- If you use the defog and HLC functions at the same time, saturation can occur in a bright environment.
- Because there can be a difference in the effectiveness of HLC according to the amount of light area in the screen, optimize the installation angle for the best HLC performance.
- When dark, the HLC is only activated when a bright light exceeding a specific size. (In NIGHT ONLY mode).
- The HLC is not activated in day light or when bright light is not present at night. (In NIGHT ONLY mode).

SPECIAL

1. When the SETUP menu screen is displayed, select 'SPECIAL' by using the Function Setup switch so that the arrow indicates 'SPECIAL'.
2. Select a desired mode using the Function Setup switch.

● DISPLAY

- ① If the SPECIAL menu screen is displayed, use the Function Setup switch so that the arrow indicates 'DISPLAY'.
- ② Select a desired mode using the Function Setup switch.

MAIN SETUP	
1. VIDEO FORMAT	AHD _↓
2. PROFILE	BASIC
3. D-WDR	ON _↓
4. WHITE BAL	ATW
5. EXPOSURE	↓
6. BACKLIGHT	OFF
▶ 7. SPECIAL	↓
8. SIMPLE FOCUS	↓
9. EXIT	SAVE

- CAM TITLE

- ① If the DISPLAY menu screen is displayed, use the Function Setup switch so that the arrow indicates 'CAM TITLE'.
- ② Set it to 'ON' by using the Function Setup switch.
- ③ Press the Function Setup switch.
- ④ Use the Function Setup switch to move to a desired letter and select the letter by pressing the Function Setup switch. Repeat this to enter multiple letters. You can enter up to 15 letters.

CAM TITLE														
A	B	C	D	E	F	G	H	I	J	K	L	M	N	O
P	Q	R	S	T	U	V	W	X	Y	Z	_	.	0	1
2	3	4	5	6	7	8	9							
← → CLR POS END														
█ -----														

camera operation

- ⑤ Enter a title, move the cursor to 'POS' and press the Function Setup switch. The entered title appears on the screen. Select the position to display the title on the screen by using the Function Setup switch and press the Function Setup switch. When the position is determined, select 'END' and press the Function Setup switch to return to the DISPLAY menu.



- When the CAM TITLE menu is 'OFF', no title will be displayed on the monitor screen even if you enter one.
 - and Numbers are available in this mode.
 - If you move the cursor to CLR and press the Function Setup switch, all the letters are deleted. To edit a letter, change the cursor to the bottom left arrow and press the Function Setup switch. Move the cursor over the letter to be edited, move the cursor to the letter to be inserted and then press the Function Setup switch.
 - FONT COLOR : You can change the OSD font color. (White, Yellow, Green, Red, Blue)
 - LANGUAGE : You can select the menu language according to your requirements.
 - RETURN : Return to the SPECIAL menu.
- **COMM ADJ (Communication Adjustment) :**
This function sets up the camera communication status when controlling the camera through an external control device.

- ① If the SPECIAL menu screen is displayed, use the Function Setup switch so that the arrow indicates 'COMM ADJ'.

- ② Select a desired mode using the Function Setup switch.

- **PROTOCOL :**
Select the communication SAMSUNG-T/SAMSUNG-E/PELCO-D/PELCO-P/BOSCH/HONEYWELL)

- **CAM ID :** Determines the camera's identification number (between 0 and 255).
- **DISP ID :** Determines whether camera ID is displayed or not.
- **BAUD RATE :** You can select 2400/4800/9600/19200/38400 bps .
- **UART MODE :** You can select NONE, EVEN or ODD for the parity bits.

COMM SETUP	
▶ 1. PROTOCOL	SAMSUNG-T
2. CAM ID	1
3. DISP ID	OFF
4. BAUD RATE	9600
5. UART MODE	8-N-1
6. RET PKT	ENABLE
7. COAX	ON
8. RETURN	↓

- RET PKT : Determines whether to send a command back to the controller device when a communication control command is sent to the camera.
- COAX : You can select whether to use COAX communication.
- RETURN : Return to the SPECIAL menu.

• IMAGE ADJ

① If the SPECIAL menu screen is displayed, use the Function Setup switch so that the arrow indicates 'IMAGE ADJ'.

② Select a desired mode using the Function Setup switch.

IMAGE SETUP	
▶ 1. GAMMA	USER
2. PED LEVEL	5
3. COLOR GAIN	50
4. H-REV	OFF
5. V-REV	OFF
6. SHARPNESS	ON ◀
7. RETURN ◀	

- GAMMA : The setting range is 0.35 ~ 1.0.
The closer to 1.0 the setting is, the darker it gets.
- PED LEVEL : The setting range is 1 ~ 100. The closer to 100 the setting is, the higher the PED level gets.
- COLOR GAIN : The setting range is 1 ~ 100. The smaller the setting value is the smaller the color gain gets and the more color blind it gets.
- H-REV : Flip an image horizontally.
- V-REV : Flip an image vertically.
- SHARPNESS : Select a mode to adjust the thickness of an image's sharpness.
Increase or decrease the level of each mode to adjust the level of sharpness.
 - OFF : Released state
 - ON : The setting range is 1 ~ 32.
- RETURN : Return to the SPECIAL menu.



- When the V-REV or H-REV mode is enabled, the text on the screen does not flip.
- If you increase the SHARPNESS level too high, the picture may become distorted or noise may appear.

• DAY/NIGHT: You can display pictures in color or in black and white.

① If the SPECIAL menu screen is displayed, use the Function Setup switch so that the arrow indicates 'DAY/NIGHT'.

② Select a desired mode using the Function Setup switch according to the picture display you want.

camera operation

- **AUTO** : The mode is switched to 'Color' in a normal environment, but switches to 'B/W' mode when ambient illumination is low. To set up the switching time for AUTO mode, press the Function Setup switch. You can turn on or off the burst signal on B/W mode.

AUTO SETUP	
▶ 1. BURST MODE	ON
2. DURATION	NORMAL
3. DWELL TIME	30 SEC
4. RETURN	←↓

- **BURST MODE** : Activate or deactivate the burst mode to maintain or remove the color signal.
- **DURATION** : This function is used to select the brightness of light where switching occurs.
- **DWELL TIME** : You can select day/night switching delay time from.
→ 3s, 5s, 7s, 10s, 15s, 20s, 30s, 40s, 60s



- If you set the AGC mode to off on the exposure menu, you cannot switch the day/night mode to auto.
- When a bright light source is in the screen or there are frequent brightness changes, if you use the auto night/day mode, and set the switching time to short (3, 5 sec), a hunting can be caused. In this situation, it is recommended to use the default setting (30 sec).

- **EXTERN** : Ground to the grounding terminal to allow automatic switching between COLOR and B/W (Black/White).
- **COLOR** : The picture is always displayed in color.
- **B/W** : The picture is always displayed in black and white.
You can turn on or off the burst signal on B/W mode.



- If the lens mounted in the camera is different from the one set in <LENS> of the <EXPOSURE> menu, then the night/day mode may not operate normally.
- **DEFOG** : You can use the defog mode to allow the camera to automatically detect the fog density of the screen and display a clear image despite smog, fog or general poor visibility.
 - ❶ If the SPECIAL menu screen is displayed, use the Function Setup switch so that the arrow indicates 'DEFOG'.
 - ❷ Select a desired mode using the Function Setup switch.
- **AUTO** : Adjust the level automatically.

- Manual : Depending on the defog level set by the user, adjust the clarity of image. (LOW, MIDDLE, HIGH)
- OFF : Released state

DEFOG	
▶ 1. LEVEL	MIDDLE
2. RETURN	↵



- If the defog mode is set to Auto, and if the amount of fog is reduced, the function level will be also reduced. If you want to maintain the same level of defogging, set it to Manual.
- If there is little fog and the manual fog level is high, the screen contrast can get high.

• **PRIVACY:** Mask an area you want to hide on the screen.

- 1 If the SPECIAL menu screen is displayed, use the Function Setup switch so that the arrow indicates 'PRIVACY'.

- 2 Select a desired mode using the Function Setup switch.

- AREA : You can select up to 4 PRIVACY areas.
- MODE : Determines whether to use the area selected in the AREA.
- MASK COLOR : Determine area color. You can select Green, Red, Blue, Black, White, Gray.
- TRANSPARENCY : Adds or removes transparency from the masking area.
- TOP / BOTTOM / LEFT / RIGHT : Adjust the size and position of the selected area.
- RETURN : Return to the SPECIAL menu.

PRIVACY AREA	
▶ 1. AREA	AREA1
2. MODE	OFF
3. MASK COLOR	GREEN
4. TRANSPARENCY	OFF
5. TOP	16
6. BOTTOM	46
7. LEFT	6
8. RIGHT	23
9. RETURN	↵

• **MOTION :**

This product generates signals each time an object movement is detected in the four areas of the screen so efficient monitoring can be achieved.

- 1 If the SPECIAL menu screen is displayed, use the Function Setup switch so that the arrow indicates 'MOTION'.

- 2 Select a desired mode using the Function Setup switch.

- DET. AREA : Set the areas of motion detection.
 - SEL AREA : Select from four areas that users want.

MOTION DET	
▶ 1. DET. AREA	↵
2. ALARM OUT	↵
3. SENSITIVITY	5
4. RETURN	↵

camera operation

- **MODE** : Determine whether to use the selected area.
- **MASK** : Under Motion Detection, If you don't want to see mosaic image on the screen, you may turn MASK OFF.
If you wants to see mosaic image, please turn it on.
- **TRANSPARENCY**: Adds or removes transparency from the masking area.
- **TOP/BOTTOM/LEFT/RIGHT** : Area location can be adjusted.
- **RETURN** : Return to the MOTION DET menu.
- **ALARM OUT** : When object movement is detected, the detection signal will be outputted.

ALARM OUT	
▶ 1.EXTERNAL	ON
2.OSD	ON
3.RETURN ↵	
- **EXTERNAL** : Send signals through external terminals.
- **OSD** : Display signals on the screen.
- **RETURN** : Return to the MOTION DET menu.
- **SENSITIVITY** : Set the sensitivity of the motion detection. When you adjust the higher level, the more sensitive.
- **RETURN** : Return to the SPECIAL SETUP menu.



- Depending on the shape of an object, there can be errors in size detection.
- If the camera shoots an object a short distance away, the motion detection function can be degraded.
- In the following cases, motion detection event performance can be degraded or malfunctions can occur.
 - If an object's brightness or color is similar to that of the background
 - If there is little movement near the screen edge
 - If multiple movements keeps occurring randomly, such as scene switching or sudden light changes
 - If an object fixed in the same location keeps moving
 - Moving away from the camera or approaching the camera. Little location change on the screen.
 - If a moving object approaches the camera
 - If random objects obstruct the view of each other
 - If more than one objects merge or one object divides into multiple objects
 - If an object moves too fast (the same object should have overlapping areas between the consecutive frames)
 - If there are reflections/blurs/shadows created by a strong light such as direct sunlight, lights, and headlights.

- Severe snow, rain and wind. Sunset or sunrise
- If the size is greater than the max size or smaller than the min size, motion is not detected. To avoid false detection caused by noises, set the max/min detection size suitable for the installation environment.
But the same movement in the same location can cause a different detection size. So, include margins when you set the min/max detection size.

EXIT

Select a desired EXIT mode using the Function Setup switch depending on the camera purpose.

- **SAVE** : Save the current settings and exit the MAIN SETUP menu.
- **NOT SAVE** : Do not save the current settings and exit the MAIN SETUP menu.
- **RESET** : Revert camera to factory settings. (The language, communication and lens settings will remain the same).

troubleshooting

Troubleshooting

If you have trouble operating your camera, refer to the following table.

If the guidelines do not enable you to solve the problem, contact an authorized technician.

Problems	Troubleshooting
Nothing appears on the screen.	<ul style="list-style-type: none">• Check that the power cord and line connection between the camera and AHD DVR are properly connected.• Check that you have properly connected BNC cable to the camera.• Check the type of lens.
The image on the screen is dim.	<ul style="list-style-type: none">• Is lens stained with dirt? Clean your lens with soft, clean cloth.• Set the monitor or DVR to the proper condition.• If the camera is exposed to very strong light, change the camera position.
The image on the screen is dark.	<ul style="list-style-type: none">• Adjust the contrast feature of the monitor or DVR.• If you have an intermediate device, set the 75Ω / Hi-z properly.
The camera is not working properly, and the surface of the camera is hot.	<ul style="list-style-type: none">• Check that you have properly connected the camera to an appropriate power source.
The DAY/NIGHT menu does not work.	<ul style="list-style-type: none">• Check that AGC of EXPOSURE SETUP menu is 'OFF'.
Color is not correct.	<ul style="list-style-type: none">• Check the setting of WHITE BAL SETUP menu
The screen flickers continually.	<ul style="list-style-type: none">• Ensure the camera is not pointing towards the sun.
When coaxial communication is not available	<ul style="list-style-type: none">• Make sure that the camera, DVR and monitor are installed within the recommended distance.

specifications

SPECIFICATIONS

	HCB-6001N	HCB-6001P
Video		
Imaging Device	1/2.8" 2M CMOS	
Total Pixels	1,945(H) x 1,109(V) 2.16M pixels	
Effective Pixels	1,945(H) x 1,097(V) 2.13M pixels	
Scanning System	Progressive Scan	
Min. Illumination	Color: 0.15Lux(F1.2) B/W: 0.09Lux(F1.2)	
S / N Ratio	52dB (AGC off, Weight on)	
Video Output	BNC(AHD / TVI / CVI / CVBS Selectable)	
Resolution	1920 x 1080	
Max. Framerate	30fps @1080p, 30fps@ 720p	
Lens Type		
Focus Control	Simple Focus / Manual, Button Control(Manual, Simple Focus, Day&Night)	
Lens Type	Manual / DC Auto Iris	
Mount Type	C/CS	
Operational		
On Screen Display	English, Korean, Japanese, German, Italian, French, Spanish, Russian, Czech, Polish, Romanian, Serbian, Swedish, Danish, Turkish, Portuguese	
Camera Title	Off / On (Displayed 15 characters)	
Day & Night	Auto (ICR) / External / Color / B/W	
Backlight Compensation	Off / User BLC / HLC	
Wide Dynamic Range	120dB	
Digital Noise Reduction	SSNR4 (Off / On)	
Defog	AUTO / MANUAL / OFF	
Digital Image Stabilization	Not support	
Motion Detection	Off / On(4 zones)	
Privacy Masking	Off / On (4zones rectangle)	
Gain Control	Off / Low / Middle / High / Very High	
White Balance	ATW / Outdoor / Indoor / Manual / AWC(1,800K ~ 10,500K)	
Electronic Shutter Speed	1 sec ~ 1/12,000 sec	
Digital Zoom	Not support	

specifications

	HCB-6001N	HCB-6001P
Reverse	Off / H-Rev / V-Rev / HV-Rev	
Profile	Basic, Day & Night, Backlight, ITS, Indoor, User	
Intelligent Video Analytics	Not support	
Alarm	MD output 1, External D/N 1	
Remote control interface	Coaxial, RS-485	
Protocol	Coax : ACP(AHD Coax Protocol), TCP(TVI Coax Protocol), CCP(CVI Coax Protocol), COAX-C(CVBS Coax Protocol) RS-485 : SAMSUNG-T/SAMSUNG-E/PELCO-D/PELCO-P/BOSCH/HONEYWELL	
Video Transmission Distance	500m(5C2V Coaxial Cable) 300m(3C2V Coaxial Cable)	
Environmental		
Operating Temperature / Humidity	-10°C ~ +55°C (+14°F ~ +131°F) / Less than 90% RH	
Electrical		
Input Voltage/Current	Dual (24VAC±10% & 12VDC±10%)	
Power Consumption	Max. 6W	
Mechanical		
Color / Material	Ivory / Plastic Black/Metal	
Dimension (WxHxD)	130.9 mm x 73.1 x 67.2 mm.	
Weight	287g	

※ The specification for this product may change without prior notice for product improvement.

DIMENSION

Unit: mm

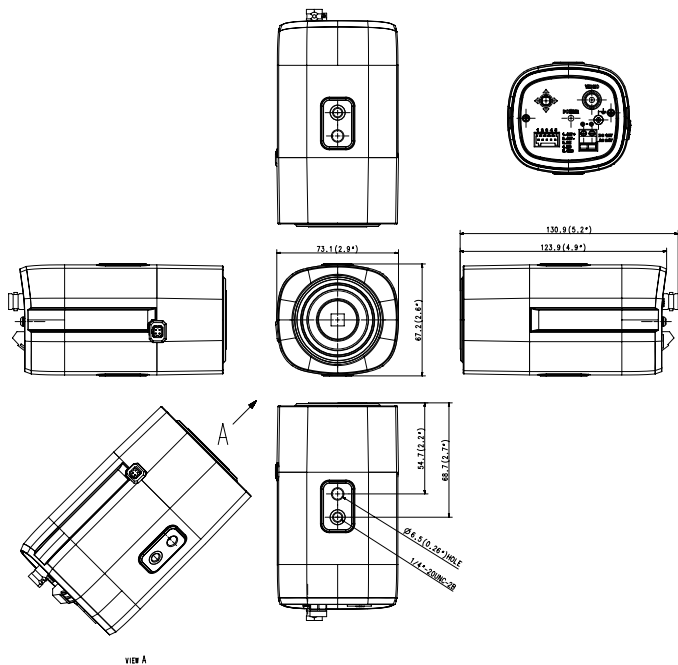

MEMO

MEMO

Head Office

6, Pangyo-ro 319 beon-gil, Bundang-gu, Seongnam-si,
Gyeonggi-do, 463-400 Rep. of KOREA
Tel : +82.70.7147.8753 Fax : +82.31.8018.3740
www.hanwha-security.com

Hanwha Techwin America

500 Frank W. Burr Blvd. Suite 43 Teaneck, NJ 07666
Toll Free +1.877.213.1222 Direct +1.201.325.6920
Fax +1.201.373.0124
www.hanwha-security.com

Hanwha Techwin Europe

Heriot House, Heriot Road, Chertsey, Surrey, KT16 9DT, United Kingdom
Tel +44.1932.57.8100 Fax +44.1932.57.8101
www.hanwha-security.eu
