

EU Declaration of Conformity

SAMSUNG



We hereby declare that the product

Type of equipment : NETWORK CAMERA
Brand Name / Trade Mark : SAMSUNG
Model number : XND-6080VP
Variant Model : -

satisfies all the technical regulations applicable to the product within the scope of Council Directives 2014/30/EU

EN 55022:2010 : Limits and methods of measurement of radio disturbance characteristics of information technology equipment
EN 50581:2012 : Technical documentation for the assessment of electrical and electronic products with respect to the restriction of hazardous substances
EN 50130-4:2011+A1:2014 : Product family standard: Immunity requirements for components of fire, intruder and social alarm systems
EN 61000-4-2:2009 : Electrostatic discharge immunity test
EN 61000-4-3:2006+A2:2010 : Radiated, radio-frequency, electromagnetic field immunity test
EN 61000-4-4:2012 : Electrical fast transient/burst immunity test
EN 61000-4-5:2014 : Surge immunity test
EN 61000-4-6:2014 : Immunity to conducted disturbances, induced by radio-frequency fields

All essential testing suites have been carried out.

Manufacturer : Hanwha Techwin (Tianjin) Co., Ltd.
Manufacturer address : No. 11 Weiliu Rd, Micro-Electronic Industrial Park, TEDA, Tianjin, 300385, People's Republic of China
Telephone / Fax : 82-02-729-2900 / 82-02-729-2904 (www.hanwhatechwin.com)
Applicant : Hanwha Techwin Co., Ltd.
Applicant address : 1204, Changwon-daero, Seongsan-gu, Changwon-si, Gyeongsangnam-do, Korea

This declaration is issued under the sole responsibility of the manufacturer and his authorised representative.

Authorized signatory

Name / Title : Jei Soon, Kang / Principal Research Engineer
Date of issue : Dec. 27, 2016



EMC TEST REPORT For CE

Test Report No. : KES-E1-16T0680
Date of Issue : Dec, 27, 2016
Product name : NETWORK CAMERA
Model/Type No. : XND-6080VP
Variant Model : -
Applicant : Hanwha Techwin Co., Ltd.
Applicant Address : 1204, Changwon-daero, Seongsan-gu, Changwon-si,
Gyeongsangnam-do, Korea
Manufacturer : Hanwha Techwin (Tianjin) Co.,Ltd.
Manufacturer Address : No.11 Weiliu Rd, Micro-Electronic Industrial
Park, TEDA, Tianjin, 300385, People's Republic of China
Date of Receipt : Nov, 23, 2016
Test date : Dec, 14, 2016 - Dec, 21, 2016
Test Results : **In Compliance** **Not in Compliance**

Tested by

Dae Hyun, Kim
EMC Test Engineer

Reviewed by

Dong-Hun, Jang
EMC Technical Manager



REPORT REVISION HISTORY

Date	Test Report No.	Revision History
Dec. 27, 2016	KES-E1-16T0680	Issued

This report shall not be reproduced except in full, without the written approval of KES Co., Ltd. This document Jun be altered or revised by KES Co., Ltd. personnel only, and shall be noted in the revision section of the document. Any alteration of this document not carried out by KES Co., Ltd. will constitute fraud and shall nullify the document.

This report shall not be reproduced except in full, without the written approval of KES Co., Ltd.
The results shown in this test report refer only to the sample(s) tested unless otherwise stated.

TABLE OF CONTENTS

1.0	General Product Description	4
1.1	Test Voltage & Frequency	7
1.2	Variant Model Differences.....	7
1.3	Device Modifications	7
1.4	Equipment Under Test.....	7
1.5	Support Equipments	7
1.6	External I/O Cabling	8
1.7	E.U.T Operating Mode(s)	9
1.8	Configuration.....	10
1.9	Calibration Details of Equipment Used for Measurement.....	11
1.10	Test Facility	11
1.11	Laboratory Accreditations and Listings	11
2.0	Test Regulations.....	12
2.1	Conducted Emissions at Mains Power Ports	14
2.2	Conducted Emissions at Telecommunication Ports	15
2.3	Radiated Electric Field Emissions(Below 1 GHz)	16
2.4	Radiated Electric Field Emissions(Above 1 GHz)	17
2.5	Harmonic Current Emissions	18
2.6	Voltage Fluctuations and Flicker	19
3.0	Criteria for compliance.....	20
3.1	Electrostatic Discharge.....	22
3.2	Radiated Electric Field Immunity	26
3.3	Electrical Fast Transients/Bursts	29
3.4	Surge Transients	32
3.5	Conducted Disturbance	36
3.6	Voltage Dips and Short Interruptions	40
APPENDIX A – TEST DATA.....		42
Conducted Emissions at Mains Power Ports.....		42
Conducted Emissions at Telecommunication Ports		44
Radiated Electric Field Emissions(Below 1 GHz)		48
Radiated Electric Field Emissions(Above 1 GHz)		49
Harmonic Current Emissions and Voltage Fluctuations and Flicker		57
Test Setup Photos and Configuration		60
Conducted Voltage Emissions		60
Conducted Telecommunication Emissions		61
Radiated Electric Field Emissions(Below 1 GHz)		63
Radiated Electric Field Emissions(Above 1 GHz)		65
Harmonic Current Emissions and Voltage Fluctuations and Flicker		67
Electrostatic Discharge		68
Radiated Electric Field Immunity		69
Electrical Fast Transients/Bursts		70
Surge Transients		72
Conducted Disturbance		74
Voltage Dips and Short Interruptions		76
EUT External Photographs		77
EUT Internal Photographs		78

1.0 General Product Description

Main Specifications of E.U.T are:

Video	
Imaging Device	1/2.8" 2M CMOS
Total Pixels	1945(H) x 1109(V) 2.16M
Effective Pixels	1945(H) x 1097(V) 2.13M
Scanning System	Progressive Scan
Min. Illumination	Color : 0.03 lux(F1.4, 1/30sec) B/W : 0.003 Lux (F1.4, 1/30sec)
S / N Ratio	50dB
Video Out	CVBS : 1.0 Vp-p / 75Ω composite, 720x480(N), 720x576(P), for installation USB : Micro USB type B, 1920 x 1080 for installation
Lens	
Focal Length (Zoom Ratio)	2.8~12mm(4.3x) motorized varifocal
Max. Aperture Ratio	1.4(Wide) ~ 3.6(Tele)
Angular Field of View	H: 119.5°, V: 62.8°, D: 142.1° H: 27.9°, V: 15.7°, D: 32.0°
Min. Object Distance	0.5m (1.64ft)
Focus Control	Simple focus(Motorized V/F) / Manual, Remote control via network (Manual, Simple focus)
Lens Type	DC Auto Iris, P-iris
Mount Type	Board-in type
Pan / Tilt / Rotate	
Pan / Tilt / Rotate range	0° ~ 354° / 0° ~ 85°(TBD) / 0° ~ 355°
Operational	
IR LED	-
Viewable Length	-
Camera Title	Off / On (Displayed up to 85 characters) - W/W : English/Numeric/Special Characters - China : English/Numeric/Special/Chinese Characters - Common : Multi-line (Max 5), Color (Grey/Green/Red/Blue/Black/White), Transparency, Auto Scale by Resolution
Day & Night	Auto (ICR) / Color / B/W / External / Schedule
Backlight Compensation	Off / BLC / HLC(Masking/Dimming), WDR
Wide Dynamic Range	150dB
Contrast Enhancement	SSDR (Off / On)
Digital Noise Reduction	SSNR5 (2D+3D Noise Filter) (Off / On)
Digital Image Stabilization	Off / On
Defog	Auto(input from fog detection) / Manual / Off
Motion Detection	Off/ On(8ea, 8point Polygonal zones), Hand over
Privacy Masking	Off / On (32ea, polygonal zones) - Color : Grey/Green/Red/Blue/Black/White - Mosaic
Gain Control	Off / Low / Middle / High
White Balance	ATW / AWC / Manual / Indoor / Outdoor((included Mercury & Sodium)
Contrast	level adjustment
LDC	On/Off (5 levels with Min/Max)
Electronic Shutter Speed	Minimum / Maximum / Anti flicker (2 ~ 1/12,000sec)
Digital PTZ	24X, 'Digital PTZ(Preset, Group)

This report shall not be reproduced except in full, without the written approval of KES Co., Ltd.
The results shown in this test report refer only to the sample(s) tested unless otherwise stated.



KES Co., Ltd.

C-3701, Simin-daero 365-40,
 Dongan-gu, Anyang-si, Gyeonggi-do, 14057, Korea
 Tel: +82-31-425-6200 / Fax: +82-31-424-0450
 www.kes.co.kr

Test report No.:
 KES-E1-16T0680
 Page (5) of (82)

Flip / Mirror	Flip : On/Off Mirror : On/Off Hallway view : 90°/270°
Video & Audio Analytics	Tampering, Loitering, Directional Detection, Defocus Detection, Fog Detection, Virtual Line, Enter/Exit, Appear / Disappear, Audio Detection, Motion Detection, Digital Auto Tracking, Sound Classification
Alarm I/O	Input 1ea / Output 1ea
Remote Control Interface	-
RS-485 Protocol	-
Alarm Triggers	Alarm Input, Motion Detection, Video & Audio Analytics, Network Disconnect
Alarm events	File upload via FTP, E-Mail Notification via E-Mail local storage(SD/SDHC/SDXC) or NAS recording at Event Triggers External output DPTZ preset
Audio In	Selectable (Mic IN/Line IN), Built-in MIC. Max output level : 1Vrms Supply voltage: 2.5VDC(4mA), Input impedance: approx. 2K Ohm
Audio out	Line out, Max output level: 1 Vrms
Fan / Heater	N/A
Pixel Counter	Support
Network	
Ethernet	RJ-45 (10/100/1000BASE-T)
Video Compression Format	H.265/H.264 (MPEG-4 Part 10/AVC) : Main/Baseline/High , Motion JPEG
Resolution	1920x1080, 1280x1024, 1280x960, 1280x720, 1024x768, 800x600, 800x450, 720x576, 640x480, 640x360, 320x240, 320x180
Max. Framerate	H.265/H.264 : Max. 60fps at all resolutions Motion JPEG : Max. 30fps
Smart Codec	Manual Mode (area-based : 5EA)
WiseStream	Support
Video Quality Adjustment	H.264/H.265 : Target Bitrate Level Control MJPEG : Target Bitrate Level Control
Bitrate Control Method	H.264/H.265 : CBR or VBR MJPEG : VBR
Streaming Capability	Multiple Streaming (Up to 10 Profiles)
Audio Compression Format	G.711 u-law /G.726 Selectable G.726 (ADPCM) 8KHz, G.711 8KHz G.726 : 16Kbps, 24Kbps, 32Kbps, 40Kbps AAC-LC : 48Kbps at 8/16/32/48KHz
Audio Communication	Bi-directional (2-Way)
IP	IPv4, IPv6
Protocol	TCP/IP, UDP/IP, RTP(UDP), RTP(TCP), RTCP,RTSP, NTP, HTTP, HTTPS, SSL/TLS, DHCP, PPPoE, FTP, SMTP, ICMP, IGMP, SNMPv1/v2c/v3(MIB-2), ARP, DNS, DDNS, QoS, PIM-SM, UPnP, Bonjour
Security	HTTPS(SSL) Login Authentication Digest Login Authentication IP Address Filtering User access Log 802.1X Authentication (EAP-TLS, EAP-LEAP)
Streaming Method	Unicast / Multicast
Max. User Access	20 users at Unicast Mode

This report shall not be reproduced except in full, without the written approval of KES Co., Ltd.
 The results shown in this test report refer only to the sample(s) tested unless otherwise stated.



KES Co., Ltd.

C-3701, Simin-daero 365-40,
 Dongan-gu, Anyang-si, Gyeonggi-do, 14057, Korea
 Tel: +82-31-425-6200 / Fax: +82-31-424-0450
 www.kes.co.kr

Test report No.:
 KES-E1-16T0680
 Page (6) of (82)

Edge Storage	SD/SDHC/SDXC 2slot (up to 512 GB) - Continuous recording(1'st slot to 2'nd slot) - Motion Images recorded in the SD/SDHC/SDXC memory card can be downloaded. NAS(Network Attached Storage) Local PC for Instant Recording
Application Programming	ONVIF Profile S/G SUNAPI(HTTP API) Open Platform
Webpage Language	English, Korean, Chinese, French, Italian, Spanish, German, Japanese, Russian, Swedish, Danish, Portuguese, Czech, Polish, Turkish, Rumanian, Serbian, Dutch, Croatia, Hungary, Greek, Norsk, Finnish
Web Viewer	Supported OS: Windows 7, 8, 10, Mac OS X 10.10, 10.11, 10.12 Non-plugin Webviewer Supported Browser: Google Chrome 54, MS Edge 38, Mozilla Firefox 49, Apple Safari 9 (Mac OS X only) Plug-in Webviewer Supported Browser: MS Explore 11, Apple Safari 9 (Mac OS X only)
Central Management Software	SmartViewer, SSM
Environmental	
Operating Temperature / Humidity	-10°C ~ +55°C (-14°F ~ +131°F) / Less than 90% RH
Storage Temperature / Humidity	-50°C ~ +60°C (-22°F ~ +140°F) / Less than 90% RH
Ingress Protection	
Vandal Resistance	IK08
Electrical	
Input Voltage / Current	12VDC ± 10%, PoE(IEEE802.3af)
Power Consumption	TBD
Mechanical	
Color / Material	IVORY / Aluminum
Dimension (WxHxD)	PND-9080R
Weight	

This report shall not be reproduced except in full, without the written approval of KES Co., Ltd.
 The results shown in this test report refer only to the sample(s) tested unless otherwise stated.



1.1 Test Voltage & Frequency

Unless indicated otherwise on the individual data sheet or test results, the test voltage and frequency was as indicated below.

Voltage 220 Vac 230 Vac 24 Vac 12 Vdc PoE
Frequency 50 Hz 60 Hz Hz

1.2 Variant Model Differences

Not applicable

1.3 Device Modifications

Not applicable

1.4 Equipment Under Test

Description	Model Number	Serial Number	Manufacturer	Remarks
NETWORK CAMERA	XND-6080VP	-	Hanwha Techwin (Tianjin) Co., Ltd.	E.U.T

1.5 Support Equipments

Description	Model Number	Serial Number	Manufacturer	Remarks
PoE Adapter	ANY4805C-LT1	10H300002	ANY ELECTRONICS CO., LTD	-
Speaker	BR10000A CUVE	-	BEIJING EDIFIER HI-TECH GROUP.	-
Mobile Phone	A1688	-	Apple Inc.	-
Micro SD Card	-	-	-	-
Notebook	ProBook4430s	-	HP	-
Notebook Adapter	SeriesPPP0009H	-	CHICONY POWER TECHNOLOGY (SUZHOU) CO.,LTD,	-
Alarm Jig	-	-	-	-

1.6 External I/O Cabling

- DC 12 V Mode

Start		END		Cable Spec.	
Description	I/O Port	Description	I/O Port	Length	Shield
NETWORK CAMERA (E.U.T)	RJ-45(LAN)	Notebook	RJ-45(LAN)	4.0	U
	Audio in	Mobile Phone	Audio Out	1.2	U
	Audio Out	Speaker	Audio in	1.1	U
	Alarm	Alarm Jig	Alarm	3.2	U
	Micro SD Card Slot	Micro SD Card	Micro SD Card Slot	-	-

- PoE Mode

Start		END		Cable Spec.	
Description	I/O Port	Description	I/O Port	Length	Shield
NETWORK CAMERA (E.U.T)	Audio in	Mobile Phone	Audio Out	1.2	U
	Audio Out	Speaker	Audio in	1.1	U
	Alarm	Alarm Jig	Alarm	3.2	U
	Micro SD Card Slot	Micro SD Card	Micro SD Card Slot	-	-
	RJ-45(PoE)	PoE Adapter	RJ-45(PoE)	4.0	U
PoE Adapter	RJ-45(LAN)	Notebook	RJ-45(LAN)	1.9	U

* Unshielded=U, Shielded=S



1.7 E.U.T Operating Mode(s)

Test mode	Normal operating
OP	E.U.T Monitoring , Ping test
PoE	

E.U.T Test operating S/W		
Name	Version	Manufacture Company
WebViewer	-	Hanwha Techwin Co., Ltd.

- Input power condition during the measurements was 12 v (dc) , PoE

1.8 Configuration

AC Main
 DC 12 V Main

- DC 12 V Mode

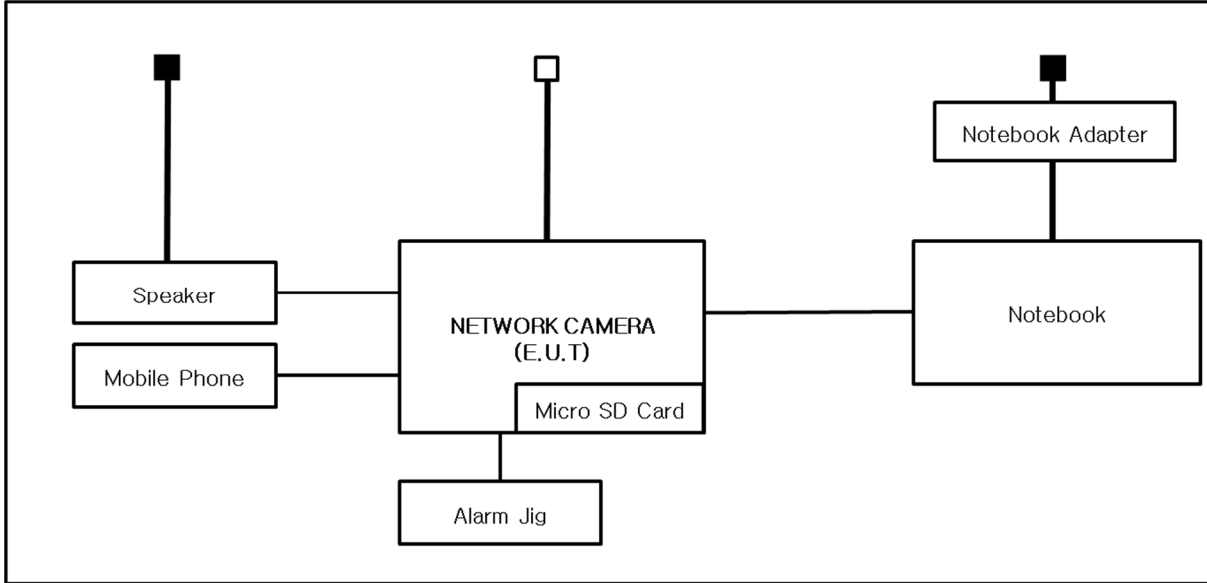

- PoE Mode

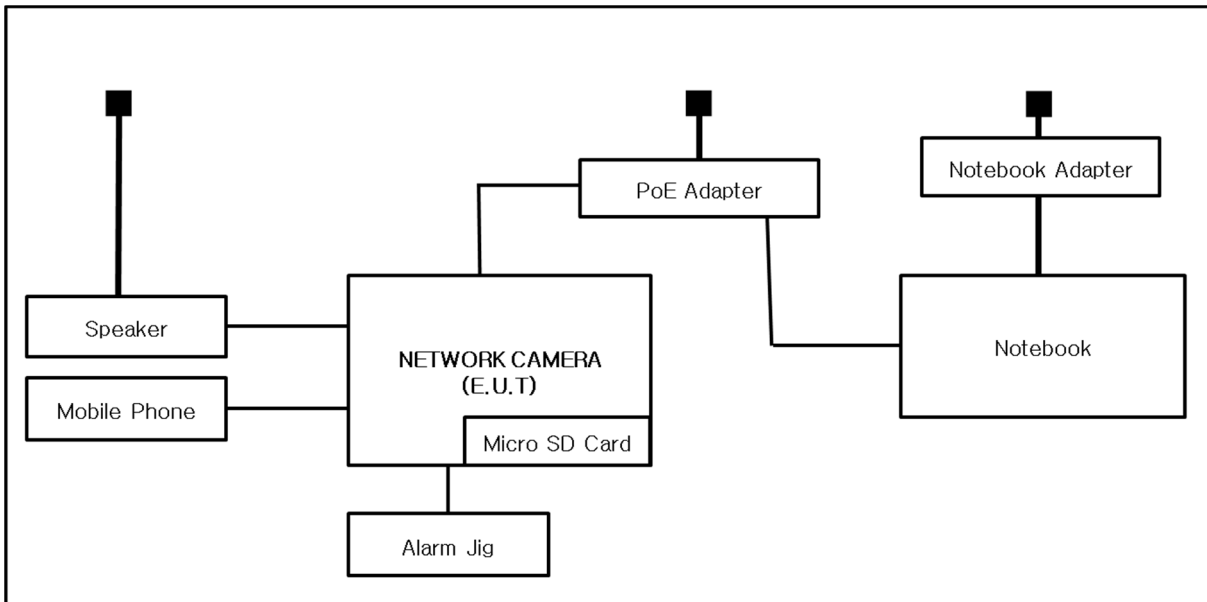

This report shall not be reproduced except in full, without the written approval of KES Co., Ltd.
 The results shown in this test report refer only to the sample(s) tested unless otherwise stated.







1.9 Calibration Details of Equipment Used for Measurement

Test equipment and test accessories are calibrated on regular basis. The maximum time between calibrations is one year or what is recommended by the manufacturer, whichever is less.

1.10 Test Facility

The measurement facility is located at 473-21 Gayeo-ro, Yeosu-si, Gyeonggi-do, 12658, Korea. The sites are constructed in conformance with the requirements of ANSI C63.4 and CISPR Publication 22.

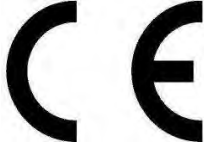
1.11 Laboratory Accreditations and Listings

Country	Agency	Scope of Accreditation	Logo
USA	FCC	3 & 10 meter Open Area Test Sites and one conducted site to perform FCC Part 15/18 measurements.	
JAPAN	VCCI	Mains Ports Conducted Interference Measurement, Telecommunication Ports Conducted Disturbance Measurement and Radiation 10 meter site, Facility for measuring radiated disturbance above 1 GHz	 R-4308, C-4798, T-2311, G-914
KOREA	MSIP	EMI (10 meter Open Area Test Site and two conducted sites) Radio(3 & 10 meter Open Area Test Sites and one conducted site) EMS (ESD, RS, EFT/Burst, Surge, CS, Magnetic, Dips and interruptions)	 KR0100
Canada	IC	3 & 10 meter Open Area Test Sites and one conducted site	 4769B-1
Europe	CE	EMI (10 meter Open Area Test Site and two conducted sites) Radio(3 & 10 meter Open Area Test Sites and one conducted site) EMS (ESD, RS, EFT/Burst, Surge, CS, Magnetic, Dips and interruptions)	
International	KOLAS	EMI (10 meter Open Area Test Site and two conducted sites) Radio(3 & 10 meter Open Area Test Sites and one conducted site) EMS (ESD, RS, EFT/Burst, Surge, CS, Magnetic, Dips and interruptions)	

2.0 Test Regulations

The emissions tests were performed according to following regulations:

EMC – Directive 2014/30/EU

EN 61000-6-3:2011

EN 61000-6-1:2007

EN 61000-6-4:2007 +A1:2011

EN 61000-6-2:2005

EN 55011:2007 +A1:2010

Group 1
 Class A

Group 2
 Class B

EN 55014-1:2006 +A2:2011

EN 55014-2:1997 +A2:2008

EN 55015:2013

EN 61547:2009

EN 55022:2010

Class A

Class B

EN 55024:2010 +A1:2015

EN 50130-4:2011 +A1:2014

EN 61000-3-2:2014

EN 61000-3-3:2013

EN 61326-1:2013



-
- | | | |
|---|----------------------------------|----------------------------------|
| <input type="checkbox"/> VCCI V-3 / 2015.04 | <input type="checkbox"/> Class A | <input type="checkbox"/> Class B |
| <input type="checkbox"/> AS/NZS CISPR22:2009 +A1:2010 | <input type="checkbox"/> Class A | <input type="checkbox"/> Class B |
| <input type="checkbox"/> 47 CFR Part 15, Subpart B | | |
| <input type="checkbox"/> CISPR 22:2009 +A1:2010 | <input type="checkbox"/> Class A | <input type="checkbox"/> Class B |
| <input type="checkbox"/> ANSI C63.4-2009 | | |
| <input type="checkbox"/> IC Regulation ICES-003 : 2016 | | |
| <input type="checkbox"/> CAN/CSA CISPR 22-10 | <input type="checkbox"/> Class A | <input type="checkbox"/> Class B |
| <input type="checkbox"/> ANSI C63.4-2014 | | |
| <input type="checkbox"/> RE- Directive 2014/53/EU | | |
| <input type="checkbox"/> EN 301 489-1 V1.9.2 | | |
| <input type="checkbox"/> Equipment for fixed use | | |
| <input type="checkbox"/> Equipment for vehicular use | | |
| <input type="checkbox"/> Equipment for portable use | | |
| <input type="checkbox"/> EN 301 489-3 V1.6.1 | | |
| <input type="checkbox"/> EN 301 489-17 V2.2.1 | | |
| <input type="checkbox"/> EN 60945:2002 | | |

This report shall not be reproduced except in full, without the written approval of KES Co., Ltd.
The results shown in this test report refer only to the sample(s) tested unless otherwise stated.

2.1 Conducted Emissions at Mains Power Ports

Test Date

N/A

Test Location

Electro wave Shieldroom

Test Equipment

Used	Description	Model Number	Manufacturer	Serial Number	Cal. Due
<input type="checkbox"/>	EMI Test Receiver	ESR3	R & S	101783	05, 03, 2017
<input type="checkbox"/>	LISN	ENV216	R & S	101137	02, 04, 2017
<input type="checkbox"/>	LISN	ENV216	R & S	101786	05, 02, 2017
<input type="checkbox"/>	Electro wave Shieldroom	-	SEMITEC	-	-
<input type="checkbox"/>	EMI Test S/W	EMC32	R&S	9.12.00	-

Test ConditionsTemperature: °C
Relative Humidity: %**Frequency Range of Measurement**

150 kHz to 30 MHz

Instrument Settings

IF Band Width: 9 kHz

Test Results

The requirements are:

- PASS
 NOT PASS
 NOT APPLICABLE

RemarksDC 12 V , PoE Mode N/A :E.U.T power is 12 v (dc) power and PoE, limits are not specified

2.2 Conducted Emissions at Telecommunication Ports

Test Date

Dec, 18, 2016

Test Location

Electro wave Shieldroom

Test Equipment

Used	Description	Model Number	Manufacturer	Serial Number	Cal. Due
<input checked="" type="checkbox"/>	EMI Test Receiver	ESR3	R&S	101783	05, 03, 2017
<input checked="" type="checkbox"/>	LISN	ENV216	R&S	101137	02, 04, 2017
<input checked="" type="checkbox"/>	LISN	ENV216	R&S	101786	05, 02, 2017
<input checked="" type="checkbox"/>	8-Wire ISN CAT3	CAT3 8158	Schwarzbeck Mess	8158-0019	04, 01, 2017
<input checked="" type="checkbox"/>	8-Wire ISN CAT5	CAT5 8158	Schwarzbeck Mess	8158-0030	04, 01, 2017
<input type="checkbox"/>	8-Wire ISN CAT6	NTFM 8158	Schwarzbeck Mess	8158-0029	08, 11, 2017
<input checked="" type="checkbox"/>	Electro wave Shieldroom	-	SEMITEC	-	-
<input checked="" type="checkbox"/>	EMI Test S/W	EMC32	R&S	9.12.00	-

Test Conditions

Temperature: 19,6 °C
Relative Humidity: 39,3 %

Frequency Range of Measurement

150 kHz to 30 MHz

Instrument Settings

IF Band Width: 9 kHz

Test Results

The requirements are:

- PASS
- NOT PASS
- NOT APPLICABLE

Remarks

See Appendix A for test data.

2.3 Radiated Electric Field Emissions(Below 1 GHz)

Test Date

Dec, 19, 2016

Test Location

Open Area Test Site #1 Open Area Test Site #2

Test Equipment

Used	Description	Model Number	Manufacturer	Serial Number	Cal. Due
<input checked="" type="checkbox"/>	EMI TEST Receiver	ESR3	R&S	101781	05, 03, 2017
<input checked="" type="checkbox"/>	Trilog-Broadband ANT	VULB 9163	Schwarzbeck	9163-713	05, 15, 2017
<input checked="" type="checkbox"/>	Open Area Test Site	-	KES	-	-
<input checked="" type="checkbox"/>	Antenna Mast	-	DAEIL EMC	-	-
<input checked="" type="checkbox"/>	Turn Table	-	DAEIL EMC	-	-
<input checked="" type="checkbox"/>	EMI Test S/W	-	-	-	-

Test Conditions

Temperature: 3,6 °C
Relative Humidity: 61,0 %

Frequency Range of Measurement

30 MHz to 1 GHz

Instrument Settings

IF Band Width: 120 kHz

Test Results

The requirements are:

- PASS
 NOT PASS
 NOT APPLICABLE

Remarks

See Appendix A for test data.

2.4 Radiated Electric Field Emissions(Above 1 GHz)

Test Date

Dec, 21, 2016

Test Location

Semi Anechoic Chamber #2

Test Equipment

Used	Description	Model Number	Manufacturer	Serial Number	Cal. Due
<input checked="" type="checkbox"/>	DOUBLE RIDGED HORN ANTENNA	SAS-571	A.H.SYSTEM,INC	781	05, 07, 2017
<input checked="" type="checkbox"/>	EMI Test Receiver	ESU26	R&S	100552	04, 24, 2017
<input checked="" type="checkbox"/>	Broadband Coaxial Preamplifier	BBV 9718	Schwarzbeck Mess - Elektronik	9718-246	10, 14, 2017
<input checked="" type="checkbox"/>	Semi Anachoic Chamber #2	-	SEMITEC	-	-
<input checked="" type="checkbox"/>	Antenna Mast	-	AUDIX	-	-
<input checked="" type="checkbox"/>	Turn Table	-	AUDIX	-	-
<input checked="" type="checkbox"/>	EMI Test S/W	e3	AUDIX	8.083b	-

Test Conditions

Temperature: 19,9 °C
Relative Humidity: 39,7 %

Frequency Range of Measurement

1 GHz to 6 GHz

Instrument Settings

IF Band Width: 1 MHz

Test Results

The requirements are:

- PASS
 NOT PASS
 NOT APPLICABLE

Remarks

See Appendix A for test data.



2.5 Harmonic Current Emissions

Test Date

N/A

Test Location

Electro wave Shieldroom

Test Equipment

Used	Description	Model Number	Manufacturer	Serial Number	Cal. Due
<input type="checkbox"/>	AC Source	ACS 500 N	EM TEST	V1024106760	08, 08, 2017
<input type="checkbox"/>	Digital Power Analyzer	DPA 500 N	EM TEST	V1024106759	08, 08, 2017
<input type="checkbox"/>	EMI Test S/W	dpa.control	EM TEST AG	5.4.8.0	-

Test Conditions

Temperature: °C

Relative Humidity: %

Classification of Equipment for Harmonic Current Emissions

- Class A
- Class B
- Class C(Below 25 W)
- Class C(Above 25 W)
- Class D

Test Results

The requirements are:

- PASS
- NOT PASS
- NOT APPLICABLE

Remarks

N/A

This report shall not be reproduced except in full, without the written approval of KES Co., Ltd.
The results shown in this test report refer only to the sample(s) tested unless otherwise stated.



2.6 Voltage Fluctuations and Flicker

Test Date

N/A

Test Location

Electro wave Shieldroom

Test Equipment

Used	Description	Model Number	Manufacturer	Serial Number	Cal. Due
<input type="checkbox"/>	AC Source	ACS 500 N	EM test	V1024106760	08, 08, 2017
<input type="checkbox"/>	Digital Power Analyzer	DPA 500 N	EM test	V1024106759	08, 08, 2017
<input type="checkbox"/>	EMI Test S/W	dpa.control	EM TEST AG	5.4.8.0	-

Test Conditions

Temperature: °C

Relative Humidity: %

Test Results

The requirements are:

- PASS
- NOT PASS
- NOT APPLICABLE

Remarks

N/A

3.0 Criteria for compliance

Criteria for compliance was based on the following guidelines:
EN 50130-4:2011 +A1:2014 Alarm systems-Part 4: Electromagnetic compatibility Product family standard: Immunity requirements for components of fire, intruder and social alarm systems

The variety and the diversity of the apparatus within the scope of this document makes it difficult to define precise criteria for the evaluation of the immunity test results.

If as a result of the application of the tests defined in this standard, the apparatus becomes dangerous or unsafe then the apparatus shall be deemed to have failed the test.

A functional description and a definition of performance by the manufacture and noted in the test report, based on the following criteria:

Electrostatic discharge

There shall be no damage, malfunction or change of status due to the conditioning.

Flickering of an indicator during the application of discharge is permissible, providing that is no residual change in the EUT or any change in outputs, which could be interpreted by associated equipment as a change.

Radiated electromagnetic fields

There shall be no damage, malfunction or change of status due to the conditioning.

Flickering of an indicator during the application of discharge is permissible, providing which could be interpreted by associated equipment as a change, and no such

Flickering of indicators occurs at a field strength of 3 V/m.

For components of CCTV systems, where the picture is allowed at 10 V/m, providing.

(a) there is no permanent damage or change to EUT

(e.g. no corruption of memory or changes to programmable setting etc.)

(b) at 3 V/m, any deterioration of the picture is so minor that the system could still be used; and

(c) there is no observable deterioration of the picture at 1 V/m.

Fast transient burst / slow high energy voltage surge

There shall be no damage, malfunction or change of status due to the conditioning.

Flickering of an indicator during the application of discharge is permissible, providing

That there is no residual is permissible, providing that there is no residual change in the EUT or any change in outputs, which could be interpreted by associated equipment as a change.

Conducted RF immunity

There shall be no damage, malfunction or change of status due to the conditioning.

Flickering of an indicator during the application of discharge is permissible, providing

That there is no residual is permissible, providing that there is no residual change in the EUT or any change in outputs, which could be interpreted by associated equipment as a change, and no such flickering of indicators oeuvres at $U = 130 \text{ dB}\mu\text{V}$.

For component of CCTV systems, where the status is monitored by observing the TV picture, then deterioration of the picture is allowed at $U = 140 \text{ dB}\mu\text{V}$, providing:

(a) there is no permanent damage or change to the EUT

(e.g. no corruption of memory or changes to programmable settings etc.)

(b) at $U = 130 \text{ dB}\mu\text{V}$, any deterioration of the picture is so minor that the system could still be used; and

(c) there in no observable deterioration of the picture at $U = 120 \text{ dB}\mu\text{V}$.

Voltage dip/interruption / Voltage variation

There shall be no damage, malfunction or change of status due to the conditioning.

Flickering of an indicator during the conditioning is permissible, providing that there is no residual

change in the EUT or any change in outputs, which could be interpreted by associated equipment

as a change. The EUT shall meet the acceptance criteria for the functional test, after the conditioning.

3.1 Electrostatic Discharge

Reference Standard

EN 61000-4-2:2009

Test Date

Dec, 17, 2016

Test Location

EMS-ESD: Electro wave Shieldroom

Test Equipment

Used	Description	Model Number	Manufacturer	Serial Number	Cal. Due
<input checked="" type="checkbox"/>	ESD SIMULATOR	ESS-2000	Noise Ken	ESS05X4620	02, 24, 2017
<input checked="" type="checkbox"/>	HCP	-	Noise Ken	-	-
<input checked="" type="checkbox"/>	VCP	-	Noise Ken	-	-
<input checked="" type="checkbox"/>	EMS Test S/W	N/A	N/A	N/A	-

Test Conditions

Temperature: 18,8 °C
Relative Humidity: 39,4 %
Atmospheric Pressure: 101,6 kPa

Test Specifications

Discharge Factor: ≥ 1 s

Discharge Impedance: 330 ohm / 150 pF

Kind of Discharge: Air, Contact (direct and indirect)

Polarity: Positive and Negative
Number of Discharge: 10 at all locations for Air discharge
10 at all locations for Contact discharge

Discharge Voltage:	Contact	Air	HCP	VCP
	<input type="checkbox"/> 2 kV	<input checked="" type="checkbox"/> 2 kV	<input type="checkbox"/> 2 kV	<input type="checkbox"/> 2 kV
	<input type="checkbox"/> 4 kV	<input checked="" type="checkbox"/> 4 kV	<input type="checkbox"/> 4 kV	<input type="checkbox"/> 4 kV
	<input checked="" type="checkbox"/> 6 kV	<input type="checkbox"/> 6 kV	<input checked="" type="checkbox"/> 6 kV	<input checked="" type="checkbox"/> 6 kV
	<input type="checkbox"/> 8 kV	<input checked="" type="checkbox"/> 8 kV	<input type="checkbox"/> 8 kV	<input type="checkbox"/> 8 kV
	<input type="checkbox"/> 15 kV	<input type="checkbox"/> 15 kV	<input type="checkbox"/> 15 kV	<input type="checkbox"/> 15 kV

Notes: HCP: Horizontal coupling plane
VCP: Vertical coupling plane

Required Performance Criteria: Complied

This report shall not be reproduced except in full, without the written approval of KES Co., Ltd.
The results shown in this test report refer only to the sample(s) tested unless otherwise stated.

Location of Discharge:

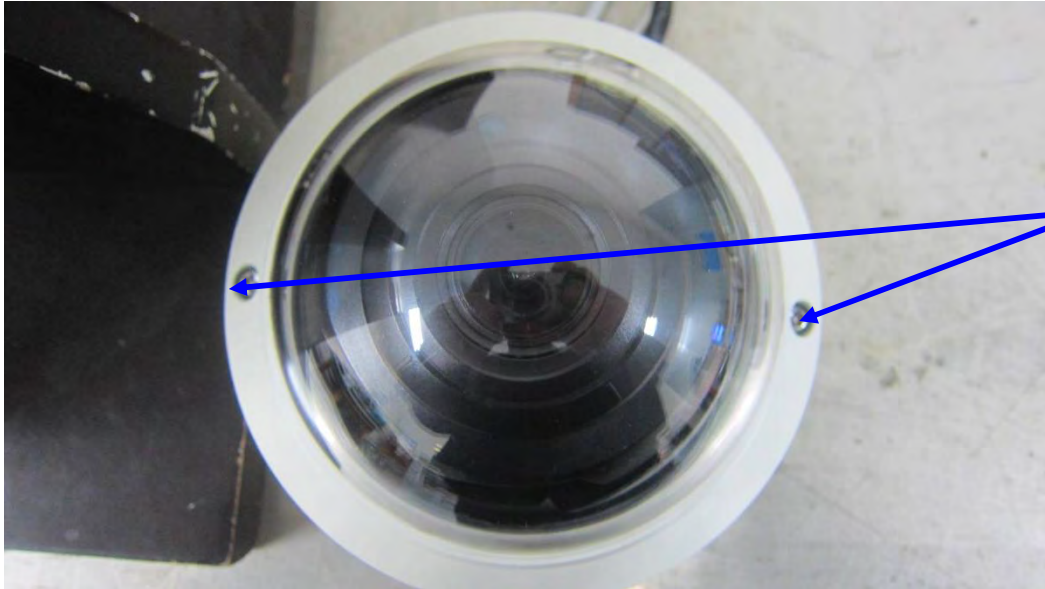
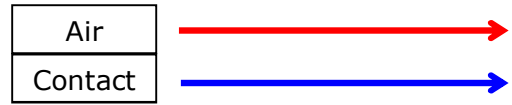

This report shall not be reproduced except in full, without the written approval of KES Co., Ltd.
The results shown in this test report refer only to the sample(s) tested unless otherwise stated.

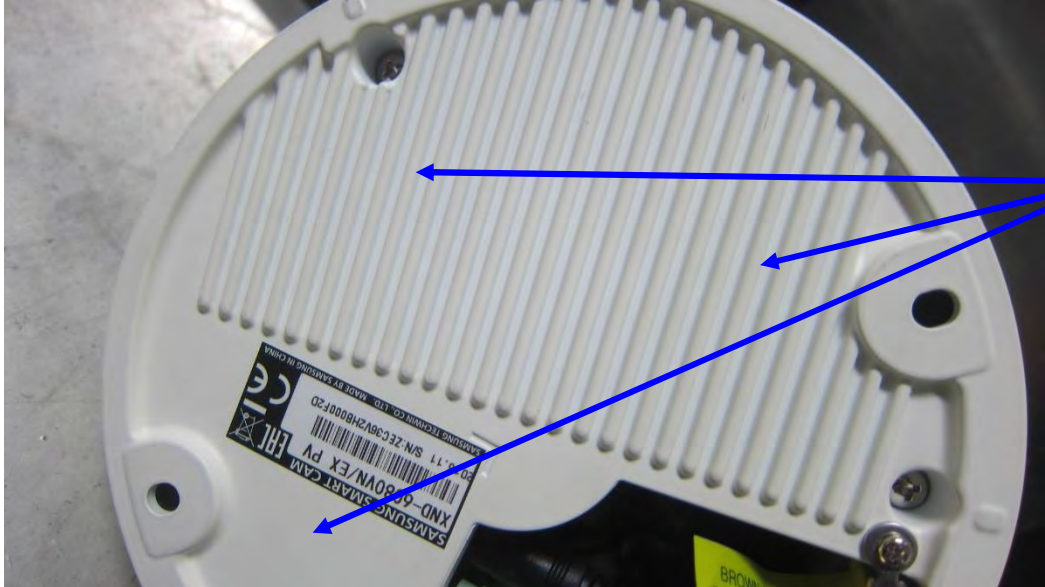

This report shall not be reproduced except in full, without the written approval of KES Co., Ltd.
The results shown in this test report refer only to the sample(s) tested unless otherwise stated.



Test Data

- DC 12 V Mode

Indirect Discharge

No.	Test Point	Discharge Method	Observations	Remarks
1	HCP Contact	Contact Discharge	Complied	-
2	VCP Contact	Contact Discharge	Complied	-

Direct Discharge

No.	Test Point	Discharge Method	Observations	Remarks
1	EUT Screw	Contact Discharge	Complied	-
2	EUT Enclosure	Contact Discharge	Complied	-

- PoE Mode

Indirect Discharge

No.	Test Point	Discharge Method	Observations	Remarks
1	HCP Contact	Contact Discharge	Complied	-
2	VCP Contact	Contact Discharge	Complied	-

Direct Discharge

No.	Test Point	Discharge Method	Observations	Remarks
1	EUT Screw	Contact Discharge	Complied	-
2	EUT Enclosure	Contact Discharge	Complied	-

Note: "Blank" = Not performed

Observations:
Complied – No degradation of function

Test Results

- PASS Required Performance Criteria
- NOT PASS Required Performance Criteria

Remarks

- N/A

3.2 Radiated Electric Field Immunity

Reference Standard

EN 61000-4-3:2006 +A2:2010

Test Date

Dec, 20, 2016

Test Location

EMS-RS: Semi Anechoic Chamber #1 Semi Anechoic Chamber #2

Test Equipment

Used	Description	Model Number	Manufacturer	Serial Number	Cal. Due
<input checked="" type="checkbox"/>	Signal Generator	ESG-3000A	HP	US37040210	11, 01, 2017
<input checked="" type="checkbox"/>	Amplifier	ITA0300-200	Infinitech	-	11, 01, 2017
<input checked="" type="checkbox"/>	Amplifier	ITA0750-200	Infinitech	-	11, 01, 2017
<input checked="" type="checkbox"/>	Amplifier	ITA1500-100	Infinitech	-	11, 01, 2017
<input checked="" type="checkbox"/>	Amplifier	ITA2500-100	Infinitech	-	11, 01, 2017
<input checked="" type="checkbox"/>	GPIB INTERFACE CONTROL	SYSTEM CONTROL UNIT	Infinitech	-	-
<input checked="" type="checkbox"/>	POWER SUPPLY	SYSTEM POWER SUPPLY	Infinitech	-	-
<input checked="" type="checkbox"/>	Power Meter	E4419B	Agilent	MY45101506	06, 27, 2017
<input checked="" type="checkbox"/>	Average Power Sensor	E9301A	Agilent	-	06, 27, 2017
<input checked="" type="checkbox"/>	Average Power Sensor	E9301A	Agilent	MY41495698	11, 17, 2017
<input checked="" type="checkbox"/>	Stacked Double Log-Per-Antenna	STPL9128 D	SCHWARZBECK	9128D038	-
<input checked="" type="checkbox"/>	Semi Anechoic Chamber #2	-	SEMITEC	-	-
<input checked="" type="checkbox"/>	EMS Test S/W	KTI_RS2012	KOREA TECHNOLOGY INSTITUTE CO., LTD	2.1.1	-

This report shall not be reproduced except in full, without the written approval of KES Co., Ltd.
The results shown in this test report refer only to the sample(s) tested unless otherwise stated.



Test Conditions

Temperature: 18,0 °C
Relative Humidity: 41,9 %
Atmospheric Pressure: 101,1 kPa

Test Specifications

Antenna Polarization: Horizontal & Vertical unless indicated otherwise

Antenna Distance: 3 m

Field Strength: 1 V/m 3 V/m
 10 V/m

Frequency Range: 80 MHz to 1 GHz 1,4 GHz to 2,7 GHz
 80 MHz to 2,7 GHz

Modulation: AM, 80 %, 1 kHz sine wave
 PM, 1 Hz (0,5 s ON : 0,5 s OFF)

Frequency step: 1 % step

Dwell Time: 1 s 3 s

of Sides Radiated: 4

Required Performance Criteria: Complied



Test Data

- DC 12 V Mode

Side Exposed	Observations	
	Horizontal	Vertical
Front	Complied	Complied
Right	Complied	Complied
Back	Complied	Complied
Left	Complied	Complied

- PoE Mode

Side Exposed	Observations	
	Horizontal	Vertical
Front	Complied	Complied
Right	Complied	Complied
Back	Complied	Complied
Left	Complied	Complied

Note: "Blank" = Not performed

Observations:
Complied – No degradation of function

Test Results

- PASS Required Performance Criteria
- NOT PASS Required Performance Criteria

Remarks

- N/A

3.3 Electrical Fast Transients/Bursts

Reference Standard

EN 61000-4-4:2012

Test Date

Dec, 15, 2016

Test Location

EMS-EFT: Electro wave Shieldroom

Test Equipment

Used	Description	Model Number	Manufacturer	Serial Number	Cal. Due
<input checked="" type="checkbox"/>	Ultra Compact Simulator	UCS 500 N5	EM TEST	V0936105120	06, 27, 2017
<input checked="" type="checkbox"/>	Capacitive Coupling Clamp	HFK	EM TEST	070925	06, 27, 2017
<input checked="" type="checkbox"/>	Motor Variac	MV2616	EM TEST	V0936105123	06, 27, 2017
<input checked="" type="checkbox"/>	EMS Test S/W	iec.control	EM TEST AG	5.0.9.0	-

Test Conditions

Temperature: 18,1 °C
Relative Humidity: 38,1 %
Atmospheric Pressure: 100,5 kPa

Test Specifications

Pulse Amplitude & Polarity: ± 1.0 kV ± 2.0 kV
(AC Power Lines) ± 4.0 kV

Pulse Amplitude & Polarity: ± 0.5 kV ± 1.0 kV
(Other supply / Signal Lines) ± 2.0 kV

Burst Period: 300 ms 2 s

Repetition Rate: 5 kHz 100 kHz

Duration of Test Voltage: ≥ 1 min

Required Performance Criteria: Complied

This report shall not be reproduced except in full, without the written approval of KES Co., Ltd.
The results shown in this test report refer only to the sample(s) tested unless otherwise stated.



Test Data

- DC 12 V Mode

Input a.c. power ports – Coupling/Decoupling Network used

Mode of Application	Observations	
	(+) Burst (kV)	(-) Burst (kV)
-	-	-

Input d.c. power ports – Coupling/Decoupling Network used

Mode of Application	Observations	
	(+) Burst (kV)	(-) Burst (kV)
L1 – L2	Complied	Complied

Signal ports and telecommunication ports – Coupling Clamp used

Mode of Application	Observations	
	(+) Burst (kV)	(-) Burst (kV)
RJ-45 (LAN)	Complied	Complied
Alarm	Complied	Complied

- PoE Mode

Input a.c. power ports – Coupling/Decoupling Network used

Mode of Application	Observations	
	(+) Burst (kV)	(-) Burst (kV)
-	-	-

Input d.c. power ports – Coupling/Decoupling Network used

Mode of Application	Observations	
	(+) Burst (kV)	(-) Burst (kV)
-	-	-

Signal ports and telecommunication ports – Coupling Clamp used

Mode of Application	Observations	
	(+) Burst (kV)	(-) Burst (kV)
RJ-45 (PoE)	Complied	Complied
Alarm	Complied	Complied

Note: “Blank” = Not performed

Observations:
 Complied – No degradation of function

Test Results

- PASS Required Performance Criteria
- NOT PASS Required Performance Criteria

Remarks

- N/A

3.4 Surge Transients

Reference Standard

EN 61000-4-5:2014

Test Date

Dec, 15, 2016

Test Location

EMS-Surge: Electro wave Shieldroom

Test Equipment

Used	Description	Model Number	Manufacturer	Serial Number	Cal. Due
<input checked="" type="checkbox"/>	Ultra Compact Simulator	UCS 500 N5	EM TEST	V0936105120	06, 27, 2017
<input checked="" type="checkbox"/>	Motor Variac	MV2616	EM TEST	V0936105123	06, 27, 2017
<input type="checkbox"/>	CDN	CNV 504N	EM TEST	V0936105121	06, 27, 2017
<input type="checkbox"/>	CDN	CNV 508T5	EM TEST	P1549168422	04, 27, 2017
<input checked="" type="checkbox"/>	CDN	CNV 508N1	EM TEST	P1551168979	04, 27, 2017
<input checked="" type="checkbox"/>	EMS Test S/W	iec.control	EM TEST AG	5.0.9.0	-

Test ConditionsTemperature: 18,1 °C
Relative Humidity: 38,1 %
Atmospheric Pressure: 100,5 kPa



Test Specifications

AC Power Lines

Source Impedance: 12 ohm for common mode and 2 ohm for differential mode

Surge Amplitude :

Common Mode

(0,5 / 1,0 / 2,0) kV

Differential Mode

(0,5 / 1,0) kV

Number of Surges:

5 surges per angle

Angle:

0°, 90°, 180°, 270° (input a.c. power port)

Polarity:

Positive & Negative

Repetition Rate:

1 surge per min 1 surge per 30 sec.

Required Performance Criteria: Complied

Other supply / Signal Lines

Source Impedance: 42 ohm for common mode

Surge Amplitude:

Common Mode

(0,5 / 1,0) kV

Number of Surges:

5 Surges

Polarity:

Positive & Negative

Repetition Rate:

1 surge per min 1 surge per 30 sec.

Required Performance Criteria: Complied

Test Data

- DC 12 V Mode

Line to Line – Differential Mode

Mode of Application	Observations	
	(+) Surge (kV)	(-) Surge (kV)
L – N	-	-
L – PE	-	-
N – PE	-	-

Line to Earth – Common Mode

Mode of Application	Observations	
	(+) Surge (kV)	(-) Surge (kV)
L1-PE	Complied	Complied
L2-PE	Complied	Complied

Signal Lines

Line to Earth – Common Mode

Mode of Application	Observations	
	(+) Surge (kV)	(-) Surge (kV)
RJ-45 (LAN)	Complied	Complied
Alarm	Complied	Complied

This report shall not be reproduced except in full, without the written approval of KES Co., Ltd.
 The results shown in this test report refer only to the sample(s) tested unless otherwise stated.

- POE Mode

Line to Line – Differential Mode

Mode of Application	Observations	
	(+) Surge (kV)	(-) Surge (kV)
L – N	-	-
L – PE	-	-
N – PE	-	-

Line to Earth – Common Mode

Mode of Application	Observations	
	(+) Surge (kV)	(-) Surge (kV)
L1-PE	-	-
L2-PE	-	-

Signal Lines

Line to Earth – Common Mode

Mode of Application	Observations	
	(+) Surge (kV)	(-) Surge (kV)
RJ-45 (PoE)	Complied	Complied
Alarm	Complied	Complied

Note: "Blank" = Not performed

Observations:
 Complied – No degradation of function

Test Results

- PASS Required Performance Criteria
- NOT PASS Required Performance Criteria

Remarks

N/A

3.5 Conducted Disturbance

Reference Standard

EN 61000-4-6:2014

Test Date

Dec, 14, 2016

Test Location

EMS-CS: Electro wave Shieldroom

Test Equipment

Used	Description	Model Number	Manufacturer	Serial Number	Cal. Due
<input checked="" type="checkbox"/>	Continuous Wave Generator	CWS 500N1	EM TEST	V0936105119	08, 08, 2017
<input checked="" type="checkbox"/>	6 dB Attenuator	ATT6	EM TEST	1208-34	08, 08, 2017
<input checked="" type="checkbox"/>	CDN	CDN-M2/M3N	EM TEST	0909-06	08, 08, 2017
<input type="checkbox"/>	CDN	CDN-T2-RJ11	EM TEST	0909-07	08, 08, 2017
<input type="checkbox"/>	CDN	CDN-T4	EM TEST	0909-08	08, 08, 2017
<input type="checkbox"/>	CDN	CDN-T8RJ45	EM TEST	0909-09	08, 08, 2017
<input type="checkbox"/>	CDN	CDN-AF2	EM TEST	0909-10	08, 08, 2017
<input type="checkbox"/>	CDN	CDN-AF4	EM TEST	0909-11	08, 08, 2017
<input checked="" type="checkbox"/>	EM Injection Clamp	EM 101	Liithi	35943	02, 04, 2017
<input checked="" type="checkbox"/>	EMS Test S/W	icd.control	EM TEST AG	5.3.7	-

Test Conditions

Temperature: 17,6 °C
Relative Humidity: 36,9 %
Atmospheric Pressure: 100,8 kPa



KES Co., Ltd.

C-3701, Simin-daero 365-40,
Dongan-gu, Anyang-si, Gyeonggi-do, 14057, Korea
Tel: +82-31-425-6200 / Fax: +82-31-424-0450
www.kes.co.kr

Test report No.:
KES-E1-16T0680
Page (37) of (82)

Test Specifications

- Frequency range: 150 kHz to 100 MHz 150 kHz to 80 MHz
- Voltage Level: 1 Vrms 3 Vrms
 10 Vrms
- Modulation: AM, 80 %, 1 kHz sine wave
 PM, 1 Hz (0,5 s ON : 0,5 s OFF)
- Frequency step: 1 % step
- Dwell Time: 1 s 3 s
- Required Performance Criteria: Complied

This report shall not be reproduced except in full, without the written approval of KES Co., Ltd.
The results shown in this test report refer only to the sample(s) tested unless otherwise stated.

Test Data

- DC 12 V Mode

Input a.c. power ports

Coupling Location (Line Stressed)	Coupling Method	Observations
-	CDN (<input type="checkbox"/> M2, <input type="checkbox"/> M3)	-

Input d.c. power ports

Coupling Location (Line Stressed)	Coupling Method	Observations
L1 - L2	CDN (<input checked="" type="checkbox"/> M2, <input type="checkbox"/> M3)	Complied

Signal ports and telecommunication ports

Coupling Location (Line Stressed)	Coupling Method	Observations
RJ-45 (LAN)	Complied	Complied
Alarm	Complied	Complied

- PoE Mode

Input a.c. power ports

Coupling Location (Line Stressed)	Coupling Method	Observations
-	CDN (<input type="checkbox"/> M2, <input type="checkbox"/> M3)	-

Input d.c. power ports

Coupling Location (Line Stressed)	Coupling Method	Observations
-	CDN (<input type="checkbox"/> M2, <input type="checkbox"/> M3)	-

Signal ports and telecommunication ports

Coupling Location (Line Stressed)	Coupling Method	Observations
RJ-45 (PoE)	Complied	Complied
Alarm	Complied	Complied

Notes: CDN = Coupling Decoupling Network
 "blank" = Not performed

Observations:
 Complied – No degradation of function

Test Results

- PASS Required Performance Criteria
- NOT PASS Required Performance Criteria

Remarks

N/A



3.6 Voltage Dips and Short Interruptions

Reference Standard

EN 61000-4-11:2004

Test Date

N/A

Test Location

EMS-Voltage dip: Electro wave Shieldroom

Test Equipment

Used	Description	Model Number	Manufacturer	Serial Number	Cal. Due
<input type="checkbox"/>	Ultra Compact Simulator	UCS 500 N5	EM TEST	V0936105120	06, 27, 2017
<input type="checkbox"/>	Motor Variac	MV2616	EM TEST	V0936105123	06, 27, 2017
<input type="checkbox"/>	EMS Test S/W	iec.control	EM TEST AG	5.0.9.0	-

Test Conditions

Temperature: °C
Relative Humidity: %
Atmospheric Pressure: kPa

This report shall not be reproduced except in full, without the written approval of KES Co., Ltd.
The results shown in this test report refer only to the sample(s) tested unless otherwise stated.



Test Specifications & Observations/Remarks

(Test Voltage : 50 Hz)

<u>Test Level</u>	<u>Duration [in period/ms (50 Hz)]</u>	<u>Results</u>
<input type="checkbox"/> 20 % dip	<input type="checkbox"/> 250 /5000	_____
<input type="checkbox"/> 30 % dip	<input type="checkbox"/> 25 /500	_____
<input type="checkbox"/> 60 % dip	<input type="checkbox"/> 10 /200	_____
<input type="checkbox"/> 100 % dip	<input type="checkbox"/> 250 /5000	_____

- Voltage variations

<input type="checkbox"/> Unom + 10 %	<input type="checkbox"/> 253 V (ac)	_____
<input type="checkbox"/> Unom - 15 %	<input type="checkbox"/> 195.5 V (ac)	_____

Observations:
Complied – No degradation of function

Test Results

- PASS Required Performance Criteria
- NOT PASS Required Performance Criteria
- NOT APPLICABLE

Remarks

N/A



APPENDIX A – TEST DATA

Conducted Emissions at Mains Power Ports

[HOT]

N/A

◆ Calculation

QuasiPeak[dBuV] / CAverage [dBuV] = Reading Value[dBuV] + Corr. [dB]

QuasiPeak / CAverage : The Final Value

Reading Value : Not shown in the table.

Corr. : Correction values (LISN FACTOR+ Cable Loss)



KES Co., Ltd.

C-3701, Simin-daero 365-40,
Dongan-gu, Anyang-si, Gyeonggi-do, 14057, Korea
Tel: +82-31-425-6200 / Fax: +82-31-424-0450
www.kes.co.kr

Test report No.:
KES-E1-16T0680
Page (43) of (82)

[NEUTRAL]

N/A

◆ Calculation

QuasiPeak[dBuV] / CAverage [dBuV] = Reading Value[dBuV] + Corr. [dB]

QuasiPeak / CAverage : The Final Value

Reading Value : Not shown in the table.

Corr. : Correction values (LISN FACTOR+ Cable Loss)

This report shall not be reproduced except in full, without the written approval of KES Co., Ltd.
The results shown in this test report refer only to the sample(s) tested unless otherwise stated.

Conducted Emissions at Telecommunication Ports

- DC 12 V Mode

[10 Mbps]

Common Information

Test Description:	Telecommunication Emission
Model No.:	XND-6080VP
Mode	DC 12 V_10 Mbps
Operator Name:	KES

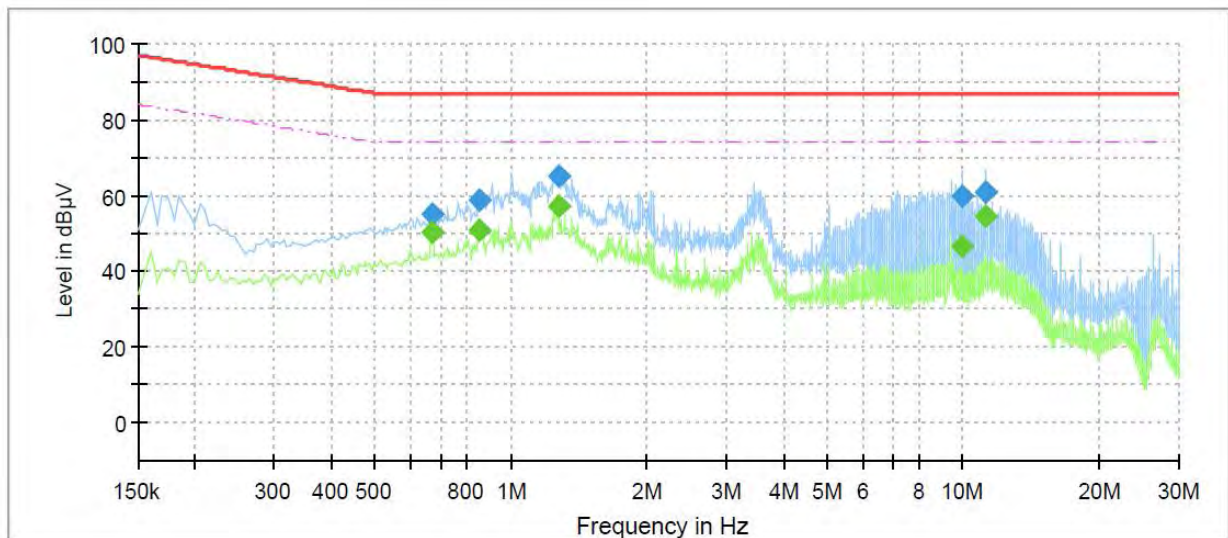

Final Result

Frequency (MHz)	QuasiPeak (dBµV)	CAverage (dBµV)	Limit (dBµV)	Margin (dB)	Meas. Time (ms)	Bandwidth (kHz)	Line	Corr. (dB)
0.670000	---	50.41	74.00	23.59	1000.0	9.000	Single Line	10.1
0.670000	55.03	---	87.00	31.97	1000.0	9.000	Single Line	10.1
0.855000	---	50.62	74.00	23.38	1000.0	9.000	Single Line	10.2
0.855000	58.79	---	87.00	28.21	1000.0	9.000	Single Line	10.2
1.270000	---	57.37	74.00	16.63	1000.0	9.000	Single Line	10.2
1.270000	65.00	---	87.00	22.00	1000.0	9.000	Single Line	10.2
9.995000	---	46.42	74.00	27.58	1000.0	9.000	Single Line	10.0
9.995000	60.02	---	87.00	26.98	1000.0	9.000	Single Line	10.0
11.250000	---	54.30	74.00	19.70	1000.0	9.000	Single Line	10.0
11.250000	60.73	---	87.00	26.27	1000.0	9.000	Single Line	10.0

◆ Calculation

QuasiPeak [dBµV] / CAverage [dBµV] = Reading Value [dBµV] + Corr. [dB]

QuasiPeak / CAverage : The Final Value

Reading Value : Not shown in the table.

Corr. : Correction values (ISN FACTOR+ Cable Loss)

[100 Mbps]

Common Information

Test Description: Telecommunication Emission
 Model No.: XND-6080VP
 Mode: DC 12 V_100 Mbps
 Operator Name: KES

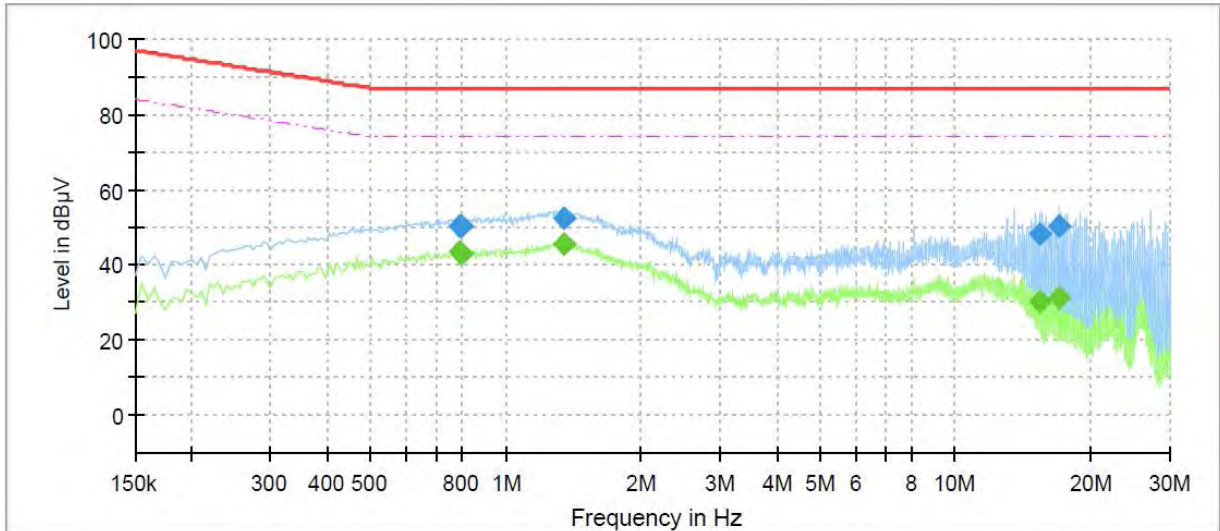

Final Result

Frequency (MHz)	QuasiPeak (dBµV)	CAverage (dBµV)	Limit (dBµV)	Margin (dB)	Meas. Time (ms)	Bandwidth (kHz)	Line	Corr. (dB)
0.785000	---	43.26	74.00	30.74	1000.0	9.000	Single Line	9.7
0.785000	50.37	---	87.00	36.63	1000.0	9.000	Single Line	9.7
0.795000	---	42.85	74.00	31.15	1000.0	9.000	Single Line	9.7
0.795000	50.31	---	87.00	36.69	1000.0	9.000	Single Line	9.7
1.345000	---	45.27	74.00	28.73	1000.0	9.000	Single Line	9.7
1.345000	52.28	---	87.00	34.72	1000.0	9.000	Single Line	9.7
1.350000	---	45.28	74.00	28.72	1000.0	9.000	Single Line	9.7
1.350000	52.32	---	87.00	34.68	1000.0	9.000	Single Line	9.7
15.330000	---	30.37	74.00	43.63	1000.0	9.000	Single Line	9.6
15.330000	47.95	---	87.00	39.05	1000.0	9.000	Single Line	9.6
16.975000	---	31.10	74.00	42.90	1000.0	9.000	Single Line	9.7
16.975000	50.46	---	87.00	36.54	1000.0	9.000	Single Line	9.7

◆ Calculation

QuasiPeak[dBuV] / CAverage [dBuV] = Reading Value[dBuV] + Corr. [dB]

QuasiPeak / CAverage : The Final Value

Reading Value : Not shown in the table.

Corr. : Correction values (ISN FACTOR+ Cable Loss)

- PoE Mode

[10 Mbps]

Common Information

Test Description:	Telecommunication Emission
Model No.:	XND-6080VP
Mode	PoE_10 Mbps
Operator Name:	KES

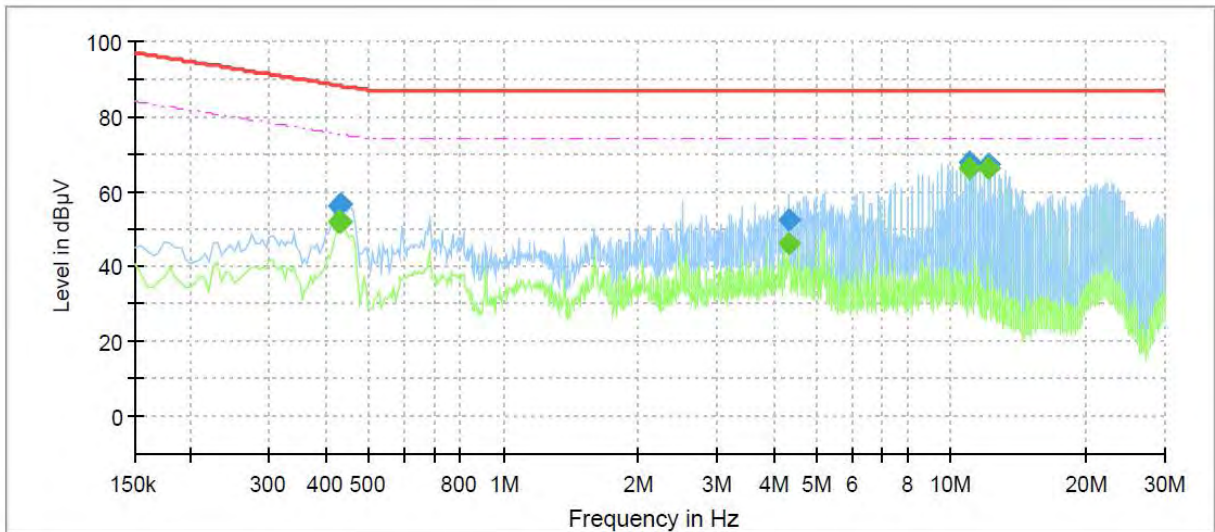

Final Result

Frequency (MHz)	QuasiPeak (dBµV)	CAverage (dBµV)	Limit (dBµV)	Margin (dB)	Meas. Time (ms)	Bandwidth (kHz)	Line	Corr. (dB)
0.430000	---	51.65	75.25	23.60	1000.0	9.000	Single Line	10.1
0.430000	56.11	---	88.25	32.14	1000.0	9.000	Single Line	10.1
0.435000	---	51.80	75.16	23.36	1000.0	9.000	Single Line	10.1
0.435000	56.40	---	88.16	31.76	1000.0	9.000	Single Line	10.1
4.350000	---	45.81	74.00	28.19	1000.0	9.000	Single Line	10.1
4.350000	52.63	---	87.00	34.37	1000.0	9.000	Single Line	10.1
10.935000	---	66.06	74.00	7.94	1000.0	9.000	Single Line	10.0
10.935000	67.60	---	87.00	19.40	1000.0	9.000	Single Line	10.0
12.075000	---	66.21	74.00	7.79	1000.0	9.000	Single Line	10.0
12.075000	67.40	---	87.00	19.60	1000.0	9.000	Single Line	10.0

◆ Calculation

QuasiPeak[dBuV] / CAverage [dBuV] = Reading Value[dBuV] + Corr. [dB]

QuasiPeak / CAverage : The Final Value

Reading Value : Not shown in the table.

Corr. : Correction values (ISN FACTOR+ Cable Loss)

[100 Mbps]

Common Information

Test Description:	Telecommunication Emission
Model No.:	XND-6080VP
Mode	PoE_100 Mbps
Operator Name:	KES

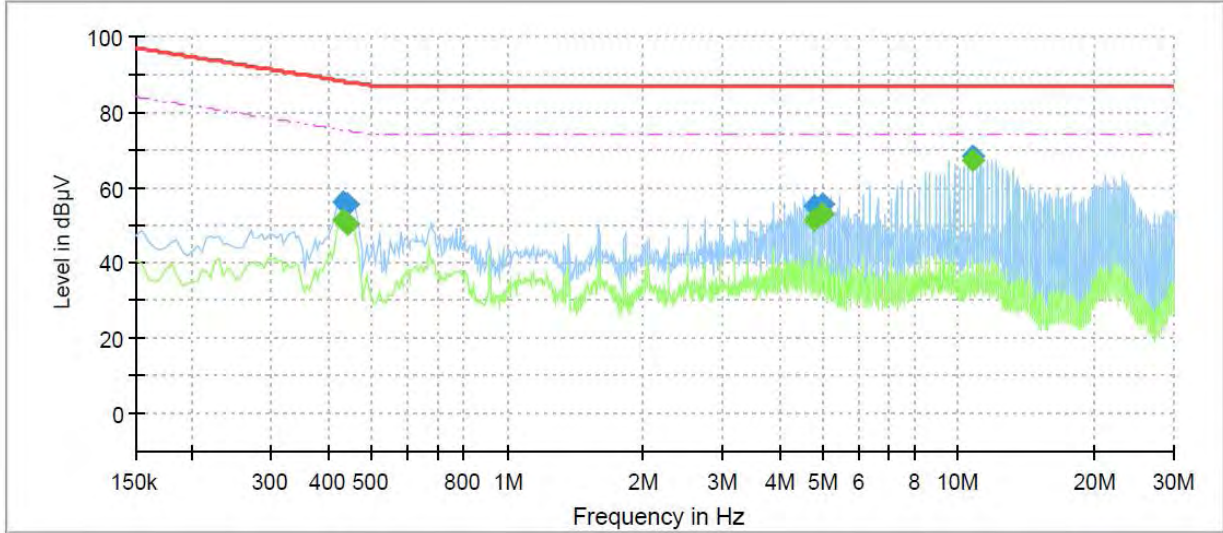

Final Result

Frequency (MHz)	QuasiPeak (dBµV)	CAverage (dBµV)	Limit (dBµV)	Margin (dB)	Meas. Time (ms)	Bandwidth (kHz)	Line	Corr. (dB)
0.435000	---	51.52	75.16	23.64	1000.0	9.000	Single Line	9.6
0.435000	56.13	---	88.16	32.03	1000.0	9.000	Single Line	9.6
0.440000	---	50.28	75.06	24.78	1000.0	9.000	Single Line	9.6
0.440000	55.46	---	88.06	32.60	1000.0	9.000	Single Line	9.6
4.785000	---	51.34	74.00	22.66	1000.0	9.000	Single Line	9.6
4.785000	55.19	---	87.00	31.81	1000.0	9.000	Single Line	9.6
5.015000	---	53.06	74.00	20.94	1000.0	9.000	Single Line	9.6
5.015000	55.72	---	87.00	31.28	1000.0	9.000	Single Line	9.6
10.710000	---	67.25	74.00	6.75	1000.0	9.000	Single Line	9.5
10.710000	68.06	---	87.00	18.94	1000.0	9.000	Single Line	9.5

◆ Calculation

QuasiPeak[dBuV] / CAverage [dBuV] = Reading Value[dBuV] + Corr. [dB]

QuasiPeak / CAverage : The Final Value

Reading Value : Not shown in the table.

Corr. : Correction values (ISN FACTOR+ Cable Loss)

Radiated Electric Field Emissions(Below 1 GHz)

- DC 12 V Mode

Frequency [MHz]	Amplitude [dB μ V]	ANT Polar. (H/V)	ANT. Height [m]	Correction Factor		Corrected Amplitude [dB μ V/m]	Applicable Limit [dB μ V/m]	Margin [dB]
				ANT. [dB/m]	Cable [dB]			
225.81	11.68	H	4.00	11.87	4.43	27.98	40.00	12.02
425.53	12.82	H	4.00	16.06	6.49	35.37	47.00	11.63
452.80	10.84	H	3.20	16.44	6.81	34.09	47.00	12.91
600.13	10.19	H	2.90	19.30	7.83	37.32	47.00	9.68
612.69	8.76	V	1.70	19.35	7.91	36.02	47.00	10.98
623.99	10.38	V	2.00	19.40	7.99	37.77	47.00	9.23

* H : Horizontal, V : Vertical

◆ Calculation

Corrected Amplitude [dB μ V] = Amplitude[dB μ V] + Correction Factor [dB]

Corrected Amplitude : The Final Value, Amplitude : Reading Value,

Correction Factor : ANT FACTOR + Cable loss

- PoE Mode

Frequency [MHz]	Amplitude [dB μ V]	ANT Polar. (H/V)	ANT. Height [m]	Correction Factor		Corrected Amplitude [dB μ V/m]	Applicable Limit [dB μ V/m]	Margin [dB]
				ANT. [dB/m]	Cable [dB]			
50.20	11.32	V	1.00	13.92	2.10	27.34	40.00	12.66
151.19	15.80	H	4.00	8.24	3.58	27.62	40.00	12.38
475.03	11.03	H	4.00	16.75	6.90	34.68	47.00	12.32
525.46	10.24	V	1.90	17.66	7.21	35.11	47.00	11.89
574.99	7.53	V	1.50	18.75	7.62	33.90	47.00	13.10
600.73	8.38	V	2.00	19.30	7.83	35.51	47.00	11.49

* H : Horizontal, V : Vertical

◆ Calculation

Corrected Amplitude [dB μ V] = Amplitude[dB μ V] + Correction Factor [dB]

Corrected Amplitude : The Final Value, Amplitude : Reading Value,

Correction Factor : ANT FACTOR + Cable loss

Radiated Electric Field Emissions(Above 1 GHz)

- DC 12 V Mode

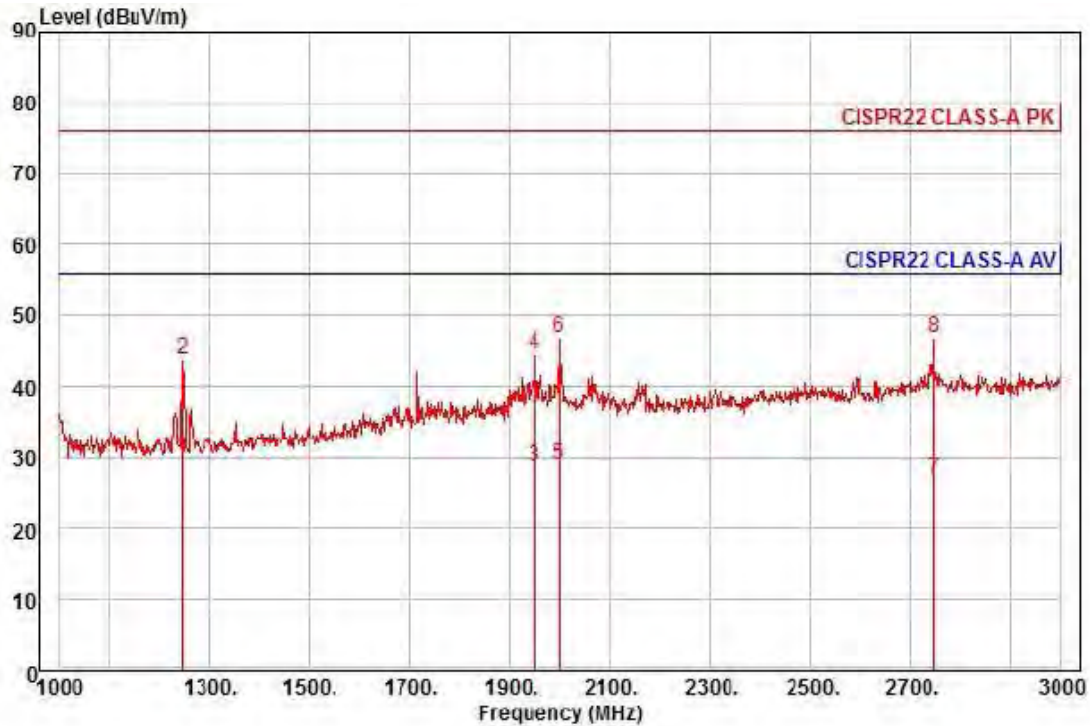

Site : chamber
 Condition: CISPR22 CLASS-A PK 3m HORN781(2015.05.07) horizontal
 : RBW:1000.000kHz VBW:1000.000kHz SWT:Auto
 Project : NETWORK CAMERA
 Model : XND-6080VP
 Mode : DC 12 V
 Memo : 1 ~ 3 GHz

	Read	Ant	Cable	Preamp	TPos	Limit	Over		
Freq	Level	Factor	Loss	Factor		Line	Limit	Pol/Phase	Remark
MHz	dBuV	dB/m	dB	dB	deg	dBuV/m	dB		
1 pp	1246.00	37.24	24.89	7.27	39.50	303	56.00	-26.10	horizontal Average
2	1246.00	51.31	24.89	7.27	39.50	303	76.00	-32.03	horizontal Peak
3	1950.00	31.30	27.68	9.21	39.39	153	56.00	-27.20	horizontal Average
4	1950.00	47.20	27.68	9.21	39.39	153	76.00	-31.30	horizontal Peak
5	2000.00	31.07	27.88	9.34	39.41	239	56.00	-27.12	horizontal Average
6	2000.00	48.98	27.88	9.34	39.41	239	76.00	-29.21	horizontal Peak
7	2748.00	25.91	29.71	11.11	39.82	2	56.00	-29.09	horizontal Average
8 pk	2748.00	45.87	29.71	11.11	39.82	2	76.00	-29.13	horizontal Peak

◆ Calculation

$$\text{Over Limit [dB]} = (\text{Read Level [dBuV]} + \text{Ant Factor [dB/m]} + \text{Cable Loss [dB]} - \text{Preamp Factor [dB]}) - \text{Limit Line [dBuV]}$$

Over Limit : Margin Value, Read Level : Reading Value, Ant Factor : Ant Factor,
 Cable Loss : Cable loss, Preamp Factor : Preamp Factor

This report shall not be reproduced except in full, without the written approval of KES Co., Ltd.
 The results shown in this test report refer only to the sample(s) tested unless otherwise stated.

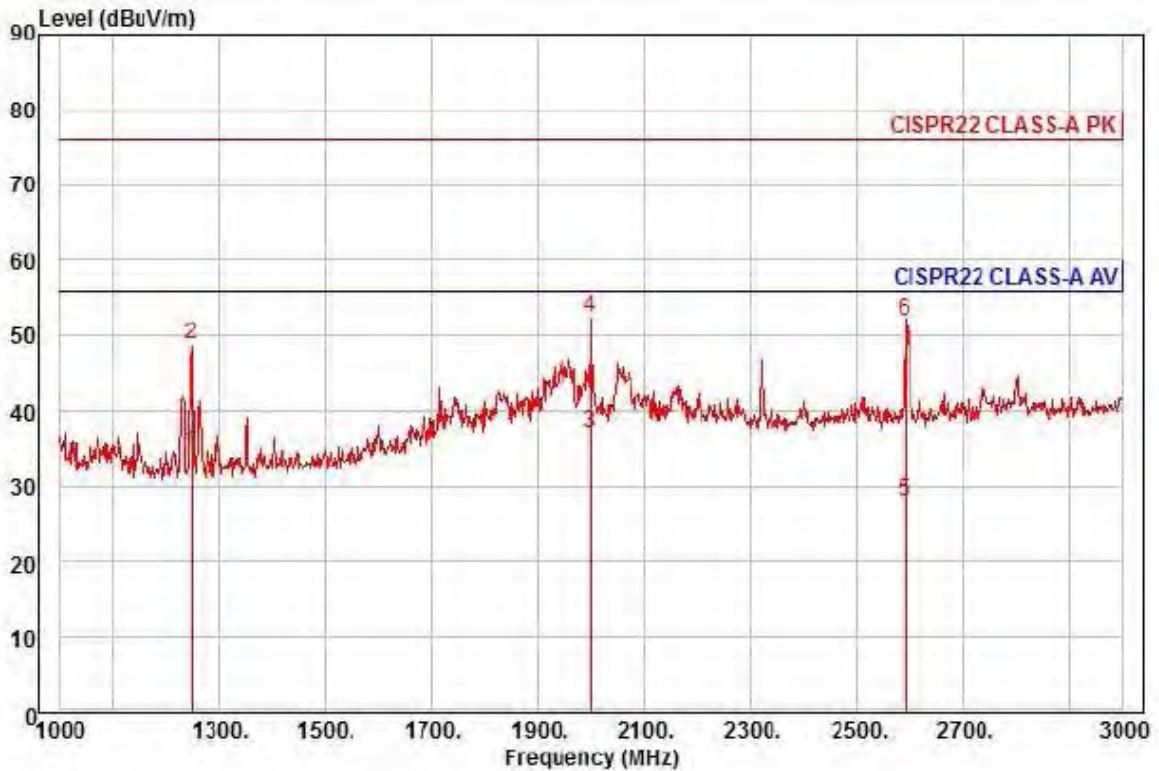

Site : chamber
 Condition: CISPR22 CLASS-A PK 3m HORN781(2015.05.07) vertical
 : RBW:1000.000kHz VBW:1000.000kHz SWT:Auto
 Project : NETWORK CAMERA
 Model : XND-6080VP
 Mode : DC 12 V
 Memo : 1 ~ 3 GHz

	Read Freq	Read Level	Ant Factor	Cable Loss	Preamp Factor	TPos	Limit Line	Over Limit	Pol/Phase	Remark
	MHz	dBuV	dB/m	dB	dB	deg	dBuV/m	dB		
1	1248.00	41.82	24.89	7.28	39.49	188	56.00	-21.50	vertical	Average
2	1248.00	56.06	24.89	7.28	39.49	188	76.00	-27.26	vertical	Peak
3 pp	2000.00	39.24	27.88	9.34	39.41	321	56.00	-18.95	vertical	Average
4 pk	2000.00	54.59	27.88	9.34	39.41	321	76.00	-23.60	vertical	Peak
5	2590.00	27.57	29.33	10.72	39.64	237	56.00	-28.02	vertical	Average
6	2590.00	51.52	29.33	10.72	39.64	237	76.00	-24.07	vertical	Peak

◆ Calculation

Over Limit [dB] = (Read Level[dBuV] + Ant Factor[dB/m] + Cable Loss [dB] - Preamp Factor [dB]) - Limit Line[dBuV]

Over Limit : Margin Value, Read Level : Reading Value, Ant Factor : Ant Factor,
 Cable Loss : Cable loss, Preamp Factor : Preamp Factor

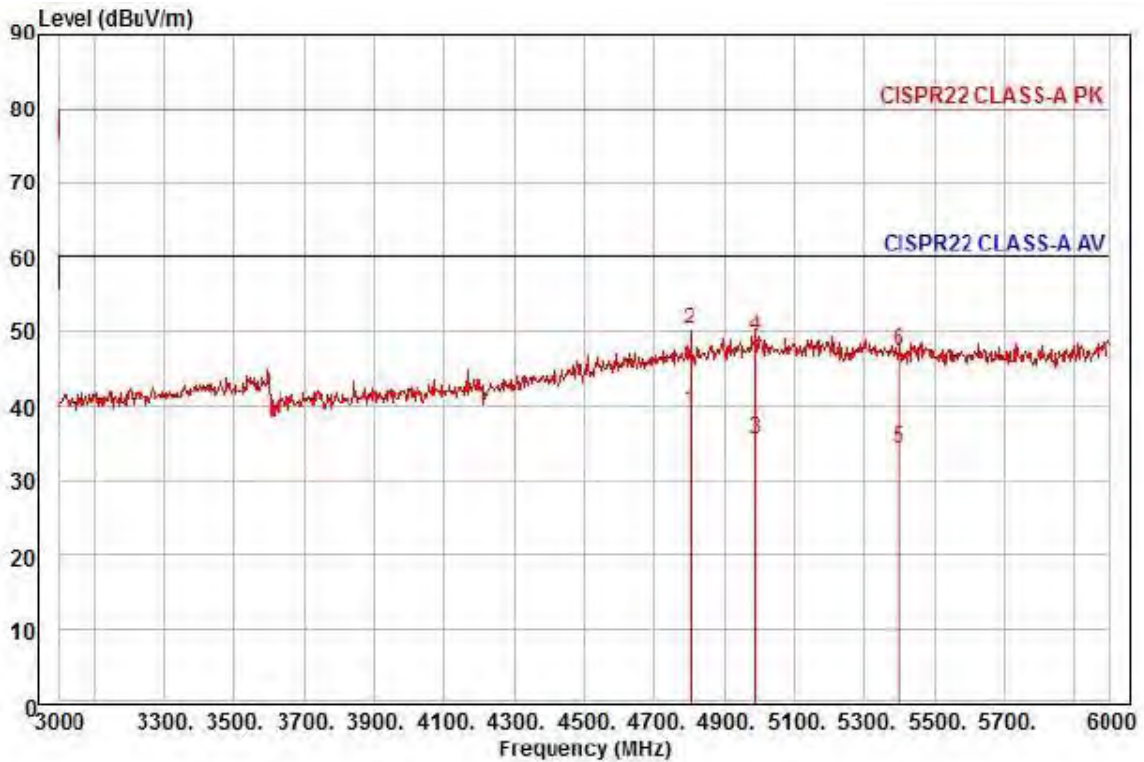

Site : chamber
 Condition: CISPR22 CLASS-A PK 3m HORN781(2015.05.07) horizontal
 : RBW:1000.000kHz VBW:1000.000kHz SWT:Auto
 Project : NETWORK CAMERA
 Model : XND-6080VP
 Mode : DC 12 V
 Memo : 3 ~ 6 GHz

	Read	Ant	Cable	Preamp	TPos	Limit	Over		
Freq	Level	Factor	Loss	Factor	deg	Line	Limit	Pol/Phase	Remark
MHz	dBuV	dB/m	dB	dB	deg	dBuV/m	dB		
1 pp	4800.00	28.08	36.58	15.10	40.47	146	60.00	-20.71	horizontal Average
2 pk	4800.00	38.97	36.58	15.10	40.47	146	80.00	-29.82	horizontal Peak
3	4986.00	22.86	37.64	15.30	40.28	115	60.00	-24.48	horizontal Average
4	4986.00	36.55	37.64	15.30	40.28	115	80.00	-30.79	horizontal Peak
5	5400.00	22.36	36.91	16.04	40.93	113	60.00	-25.62	horizontal Average
6	5400.00	35.39	36.91	16.04	40.93	113	80.00	-32.59	horizontal Peak

◆ Calculation

Over Limit [dB] = (Read Level[dBuV] + Ant Factor[dB/m] + Cable Loss [dB] - Preamp Factor [dB]) - Limit Line[dBuV]

Over Limit : Margin Value, Read Level : Reading Value, Ant Factor : Ant Factor,
 Cable Loss : Cable loss, Preamp Factor : Preamp Factor

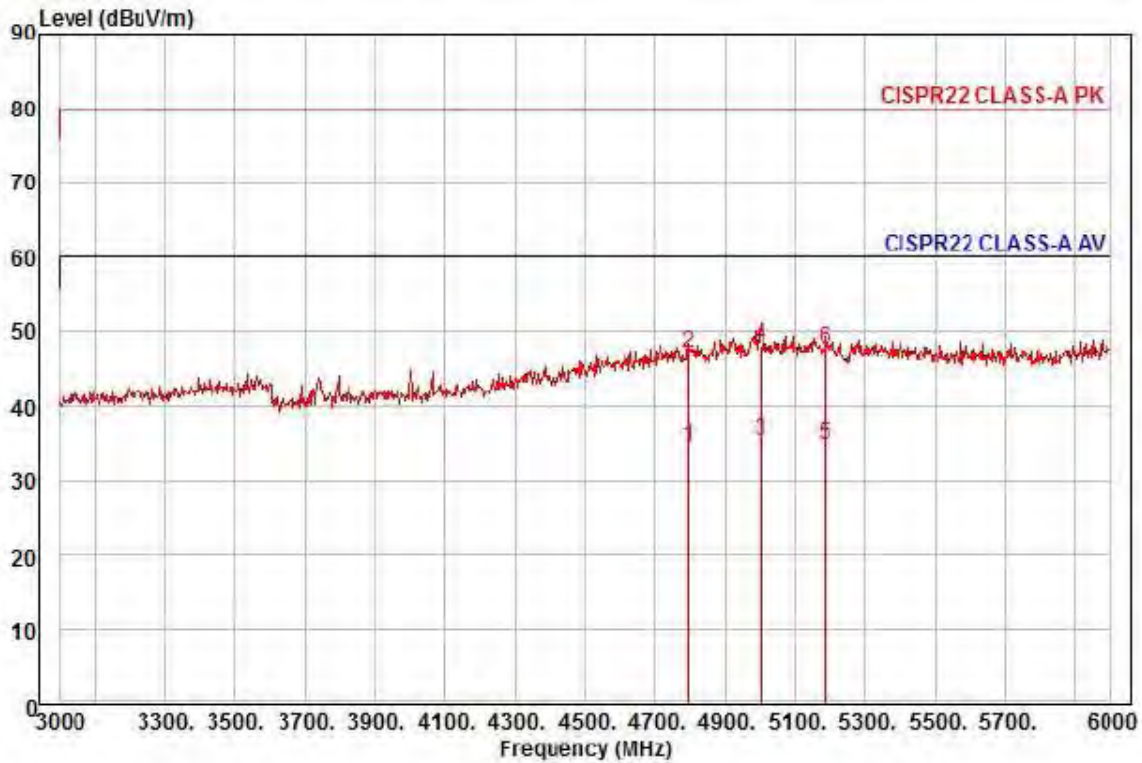

Site : chamber
 Condition: CISPR22 CLASS-A PK 3m HORN781(2015.05.07) vertical
 : RBW:1000.000kHz VBW:1000.000kHz SWT:Auto
 Project : NETWORK CAMERA
 Model : XND-6080VP
 Mode : DC 12 V
 Memo : 3 ~ 6 GHz

	Read Freq	Read Level	Ant Factor	Cable Loss	Preamp Factor	TPos	Limit Line	Over Limit	Pol/Phase	Remark
	MHz	dBuV	dB/m	dB	dB	deg	dBuV/m	dB		
1	4794.00	23.40	36.54	15.08	40.48	125	60.00	-25.46	vertical	Average
2	4794.00	36.04	36.54	15.08	40.48	125	80.00	-32.82	vertical	Peak
3 pp	5001.00	22.66	37.72	15.32	40.27	73	60.00	-24.57	vertical	Average
4 pk	5001.00	35.36	37.72	15.32	40.27	73	80.00	-31.87	vertical	Peak
5	5184.00	22.29	37.35	15.68	40.58	218	60.00	-25.26	vertical	Average
6	5184.00	35.03	37.35	15.68	40.58	218	80.00	-32.52	vertical	Peak

◆ Calculation

$$\text{Over Limit [dB]} = (\text{Read Level [dBuV]} + \text{Ant Factor [dB/m]} + \text{Cable Loss [dB]} - \text{Preamp Factor [dB]}) - \text{Limit Line [dBuV]}$$

Over Limit : Margin Value, Read Level : Reading Value, Ant Factor : Ant Factor,
 Cable Loss : Cable loss, Preamp Factor : Preamp Factor

- PoE Mode

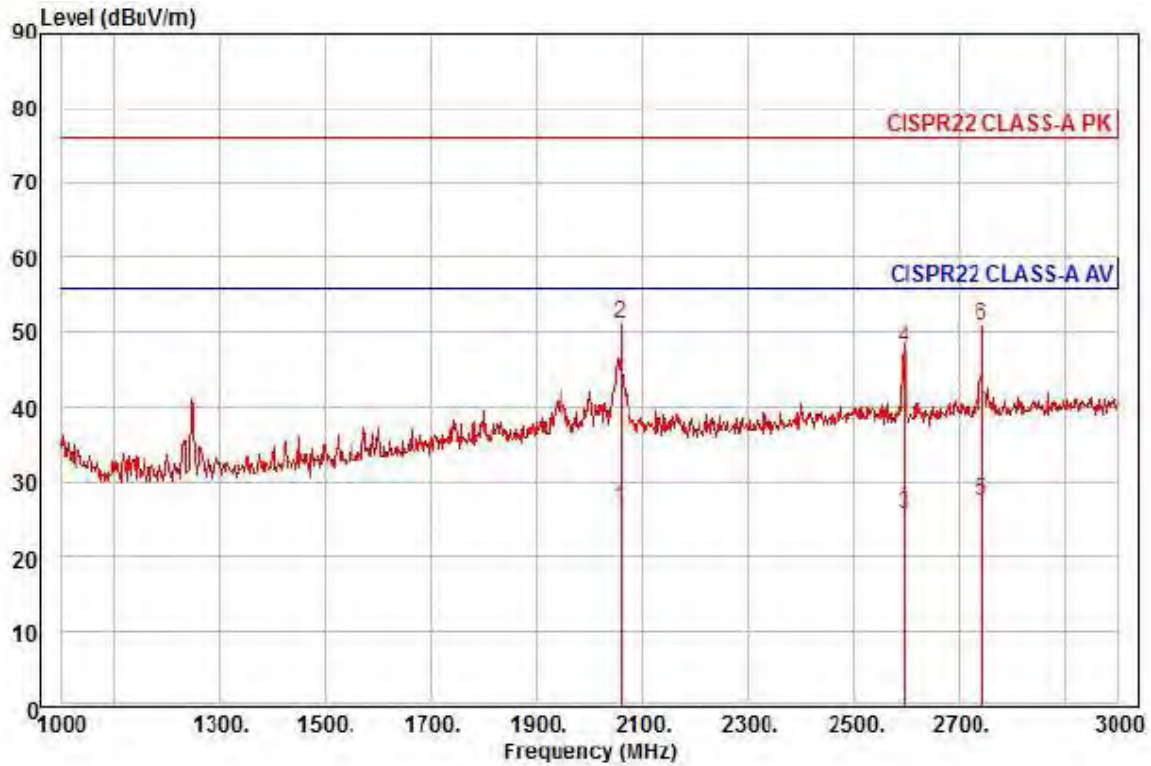

Site : chamber
 Condition: CISPR22 CLASS-A PK 3m HORN781(2015.05.07) horizontal
 : RBW:1000.000kHz VBW:1000.000kHz SWT:Auto
 Project : NETWORK CAMERA
 Model : XND-6080VP
 Mode : PoE
 Memo : 1 ~ 3 GHz

	Read	Ant	Cable	Preamp	TPos	Limit	Over		
Freq	Level	Factor	Loss	Factor		Line	Limit	Pol/Phase	Remark
MHz	dBuV	dB/m	dB	dB	deg	dBuV/m	dB		
1	2058.00	28.37	28.02	9.47	39.41	144	56.00	-29.55	horizontal Average
2 pp	2058.00	53.29	28.02	9.47	39.41	144	76.00	-24.63	horizontal Peak
3	2596.00	25.29	29.34	10.73	39.65	231	56.00	-30.29	horizontal Average
4	2596.00	47.34	29.34	10.73	39.65	231	76.00	-28.24	horizontal Peak
5 av	2744.00	26.51	29.70	11.10	39.82	38	56.00	-28.51	horizontal Average
6	2744.00	50.00	29.70	11.10	39.82	38	76.00	-25.02	horizontal Peak

◆ Calculation

Over Limit [dB] = (Read Level[dBuV] + Ant Factor[dB/m] + Cable Loss [dB] - Preamp Factor [dB]) - Limit Line[dBuV]

Over Limit : Margin Value, Read Level : Reading Value, Ant Factor : Ant Factor,
 Cable Loss : Cable loss, Preamp Factor : Preamp Factor

This report shall not be reproduced except in full, without the written approval of KES Co., Ltd.
 The results shown in this test report refer only to the sample(s) tested unless otherwise stated.

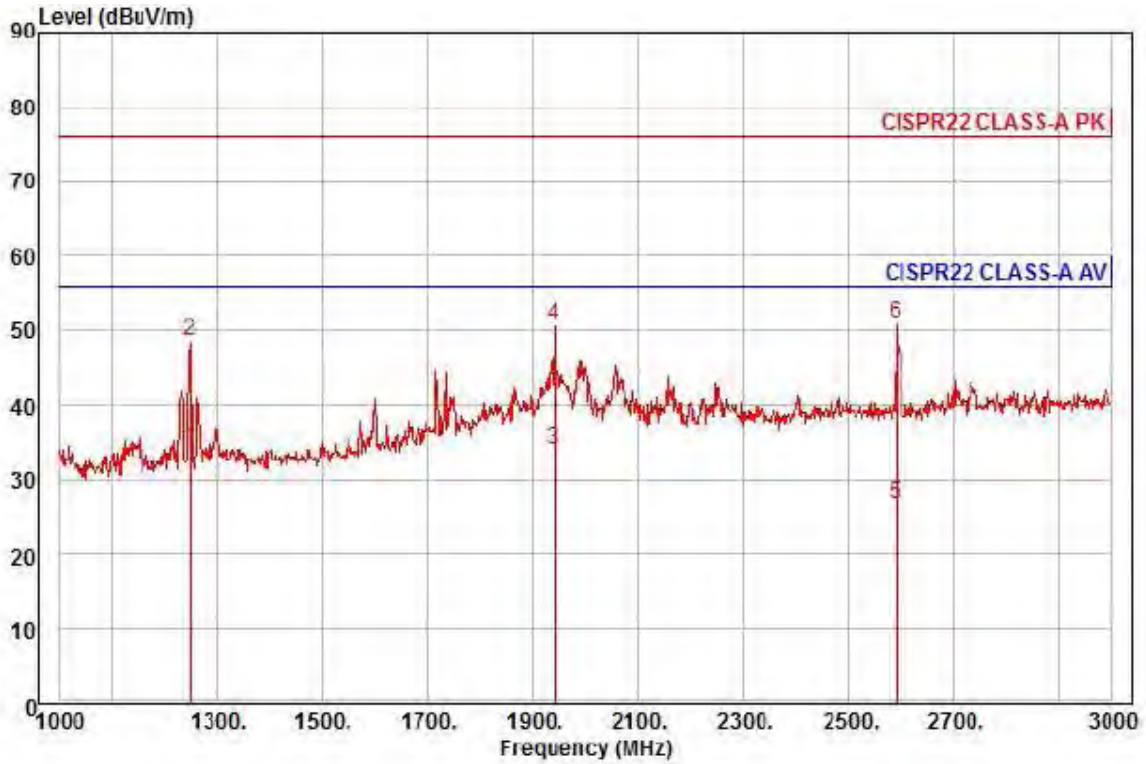

Site : chamber
 Condition: CISPR22 CLASS-A PK 3m HORN781(2015.05.07) vertical
 : RBW:1000.000kHz VBW:1000.000kHz SWT:Auto
 Project : NETWORK CAMERA
 Model : XND-6080VP
 Mode : PoE
 Memo : 1 ~ 3 GHz

	Read	Ant	Cable	Preamp	TPos	Limit	Over		
Freq	Level	Factor	Loss	Factor		Line	Limit	Pol/Phase	Remark
MHz	dBuV	dB/m	dB	dB	deg	dBuV/m	dB		
1 pp	1248.00	41.39	24.89	7.28	39.49	164	56.00	-21.93	vertical Average
2	1248.00	55.79	24.89	7.28	39.49	164	76.00	-27.53	vertical Peak
3	1940.00	36.58	27.64	9.18	39.38	218	56.00	-21.98	vertical Average
4	1940.00	53.26	27.64	9.18	39.38	218	76.00	-25.30	vertical Peak
5	2590.00	26.26	29.33	10.72	39.64	235	56.00	-29.33	vertical Average
6 pk	2590.00	50.67	29.33	10.72	39.64	235	76.00	-24.92	vertical Peak

◆ Calculation

$$\text{Over Limit [dB]} = (\text{Read Level[dBuV]} + \text{Ant Factor[dB/m]} + \text{Cable Loss [dB]} - \text{Preamp Factor [dB]}) - \text{Limit Line[dBuV]}$$

Over Limit : Margin Value, Read Level : Reading Value, Ant Factor : Ant Factor,
 Cable Loss : Cable loss, Preamp Factor : Preamp Factor

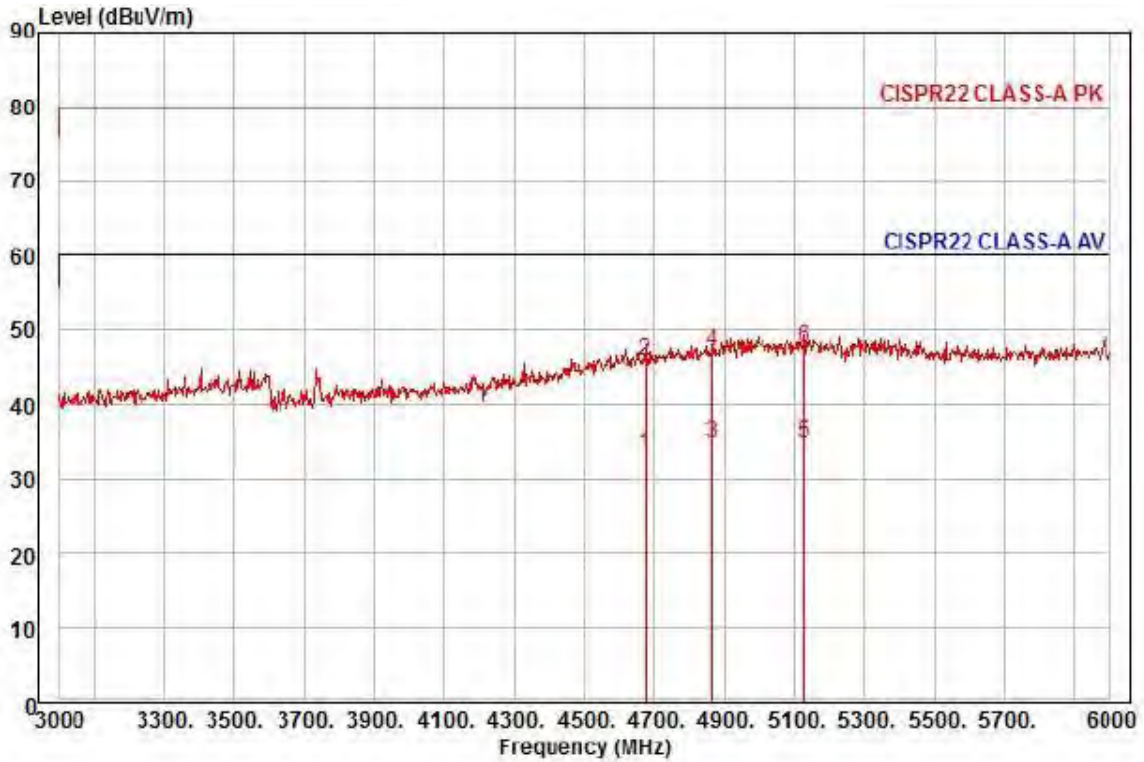

Site : chamber
Condition: CISPR22 CLASS-A PK 3m HORN781(2015.05.07) horizontal
: RBW:1000.000kHz VBW:1000.000kHz SWT:Auto
Project : NETWORK CAMERA
Model : XND-6080VP
Mode : PoE
Memo : 3 ~ 6 GHz

	Read	Ant	Cable	Preamp	TPos	Limit	Over		
Freq	Level	Factor	Loss	Factor	deg	Line	Limit	Pol/Phase	Remark
MHz	dBuV	dB/m	dB	dB	deg	dBuV/m	dB		
1	4677.00	23.16	35.88	14.83	40.59	357	60.00	-26.72	horizontal Average
2	4677.00	35.73	35.88	14.83	40.59	357	80.00	-34.15	horizontal Peak
3 pp	4866.00	23.09	36.95	15.17	40.40	50	60.00	-25.19	horizontal Average
4	4866.00	35.41	36.95	15.17	40.40	50	80.00	-32.87	horizontal Peak
5	5127.00	22.25	37.46	15.57	40.48	29	60.00	-25.20	horizontal Average
6 pk	5127.00	34.99	37.46	15.57	40.48	29	80.00	-32.46	horizontal Peak

◆ Calculation

$$\text{Over Limit [dB]} = (\text{Read Level[dBuV]} + \text{Ant Factor[dB/m]} + \text{Cable Loss [dB]} - \text{Preamp Factor [dB]}) - \text{Limit Line[dBuV]}$$

Over Limit : Margin Value, Read Level : Reading Value, Ant Factor : Ant Factor,
Cable Loss : Cable loss, Preamp Factor : Preamp Factor

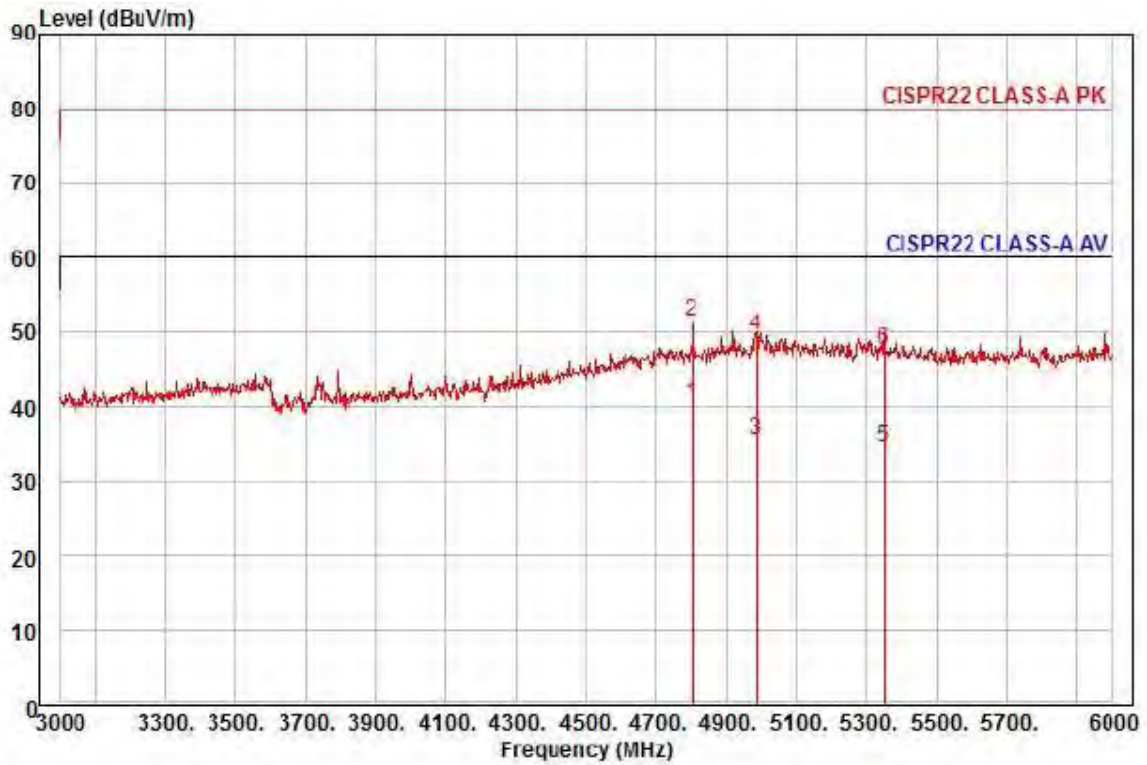

Site : chamber
 Condition: CISPR22 CLASS-A PK 3m HORN781(2015.05.07) vertical
 : RBW:1000.000kHz VBW:1000.000kHz SWT:Auto
 Project : NETWORK CAMERA
 Model : XND-6080VP
 Mode : PoE
 Memo : 3 ~ 6 GHz

	Read	Ant	Cable	Preamp	TPos	Limit	Over			
Freq	Level	Factor	Loss	Factor	deg	Line	Limit	Pol/Phase	Remark	
MHz	dBuV	dB/m	dB	dB	deg	dBuV/m	dB			
1 pp	4800.00	29.33	36.58	15.10	40.47	32	60.00	-19.46	vertical	Average
2 pk	4800.00	40.19	36.58	15.10	40.47	32	80.00	-28.60	vertical	Peak
3	4983.00	22.84	37.62	15.30	40.29	64	60.00	-24.53	vertical	Average
4	4983.00	36.85	37.62	15.30	40.29	64	80.00	-30.52	vertical	Peak
5	5349.00	22.45	37.02	15.95	40.85	121	60.00	-25.43	vertical	Average
6	5349.00	35.51	37.02	15.95	40.85	121	80.00	-32.37	vertical	Peak

◆ Calculation

$$\text{Over Limit [dB]} = (\text{Read Level [dBuV]} + \text{Ant Factor [dB/m]} + \text{Cable Loss [dB]} - \text{Preamp Factor [dB]}) - \text{Limit Line [dBuV]}$$

Over Limit : Margin Value, Read Level : Reading Value, Ant Factor : Ant Factor,
 Cable Loss : Cable loss, Preamp Factor : Preamp Factor



KES Co., Ltd.

C-3701, Simin-daero 365-40,
Dongan-gu, Anyang-si, Gyeonggi-do, 14057, Korea
Tel: +82-31-425-6200 / Fax: +82-31-424-0450
www.kes.co.kr

Test report No.:
KES-E1-16T0680
Page (57) of (82)

Harmonic Current Emissions and Voltage Fluctuations and Flicker

Average harmonic current results

Hn	I _{eff} [A]	% of Limit	Limit [A]	Result
N/A				

Harmonic currents less than 0.6% of the input current measured under the test conditions, or less than 5 mA, whichever is greater, are disregarded.

This report shall not be reproduced except in full, without the written approval of KES Co., Ltd.
The results shown in this test report refer only to the sample(s) tested unless otherwise stated.



Test Data - Harmonics (continued)

Maximum harmonic current results

Hn	I_{eff} [A]	% of Limit	Limit [A]	Result
N/A				

Harmonic currents less than 0.6% of the input current measured under the test conditions, or less than 5 mA, whichever is greater, are disregarded.

This report shall not be reproduced except in full, without the written approval of KES Co., Ltd.
The results shown in this test report refer only to the sample(s) tested unless otherwise stated.



Test Data - Voltage Fluctuations

Maximum Flicker results

	EUT values	Limit	Result
Pst	N/A		
Plt			
dc [%]			
dmax [%]			
Tmax [s]			

This report shall not be reproduced except in full, without the written approval of KES Co., Ltd.
The results shown in this test report refer only to the sample(s) tested unless otherwise stated.



KES Co., Ltd.

C-3701, Simin-daero 365-40,
Dongan-gu, Anyang-si, Gyeonggi-do, 14057, Korea
Tel: +82-31-425-6200 / Fax: +82-31-424-0450
www.kes.co.kr

Test report No.:
KES-E1-16T0680
Page (60) of (82)

Test Setup Photos and Configuration

Conducted Voltage Emissions

N/A

This report shall not be reproduced except in full, without the written approval of KES Co., Ltd.
The results shown in this test report refer only to the sample(s) tested unless otherwise stated.

Conducted Telecommunication Emissions

- DC 12 V Mode

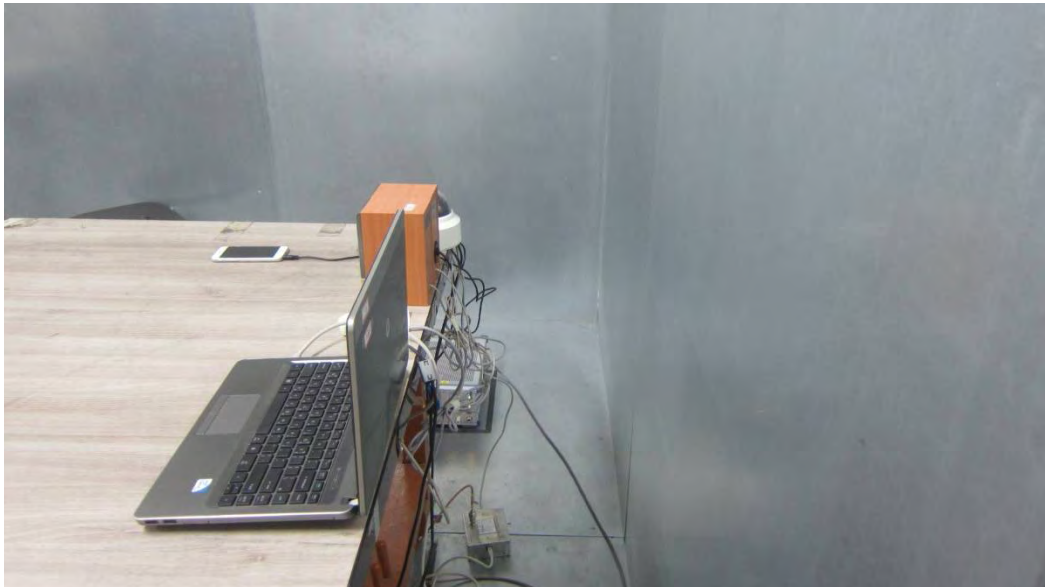

This report shall not be reproduced except in full, without the written approval of KES Co., Ltd.
The results shown in this test report refer only to the sample(s) tested unless otherwise stated.

- PoE Mode

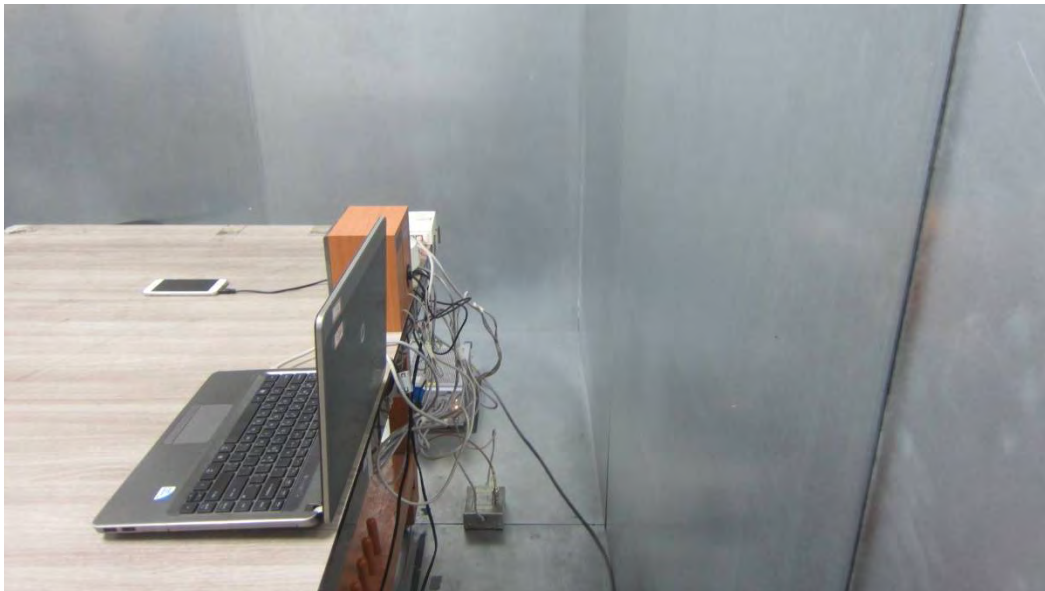

This report shall not be reproduced except in full, without the written approval of KES Co., Ltd.
The results shown in this test report refer only to the sample(s) tested unless otherwise stated.

Radiated Electric Field Emissions(Below 1 GHz)

- DC 12 V Mode



This report shall not be reproduced except in full, without the written approval of KES Co., Ltd.
The results shown in this test report refer only to the sample(s) tested unless otherwise stated.

- PoE Mode



This report shall not be reproduced except in full, without the written approval of KES Co., Ltd.
The results shown in this test report refer only to the sample(s) tested unless otherwise stated.

Radiated Electric Field Emissions(Above 1 GHz)

- DC 12 V Mode



This report shall not be reproduced except in full, without the written approval of KES Co., Ltd.
The results shown in this test report refer only to the sample(s) tested unless otherwise stated.

- PoE Mode



This report shall not be reproduced except in full, without the written approval of KES Co., Ltd.
The results shown in this test report refer only to the sample(s) tested unless otherwise stated.



KES Co., Ltd.

C-3701, Simin-daero 365-40,
Dongan-gu, Anyang-si, Gyeonggi-do, 14057, Korea
Tel: +82-31-425-6200 / Fax: +82-31-424-0450
www.kes.co.kr

Test report No.:
KES-E1-16T0680
Page (67) of (82)

Harmonic Current Emissions and Voltage Fluctuations and Flicker

N/A

This report shall not be reproduced except in full, without the written approval of KES Co., Ltd.
The results shown in this test report refer only to the sample(s) tested unless otherwise stated.

Electrostatic Discharge

- DC 12 V Mode



- PoE Mode



This report shall not be reproduced except in full, without the written approval of KES Co., Ltd.
The results shown in this test report refer only to the sample(s) tested unless otherwise stated.

Radiated Electric Field Immunity

- DC 12 V Mode



- PoE Mode

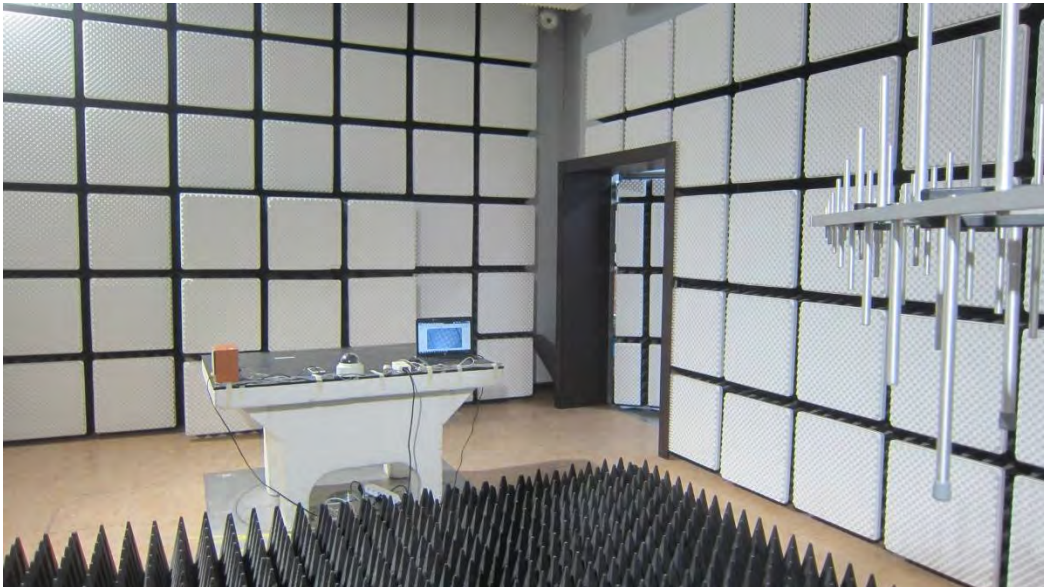

This report shall not be reproduced except in full, without the written approval of KES Co., Ltd.
The results shown in this test report refer only to the sample(s) tested unless otherwise stated.

Electrical Fast Transients/Bursts

- DC 12 V Mode

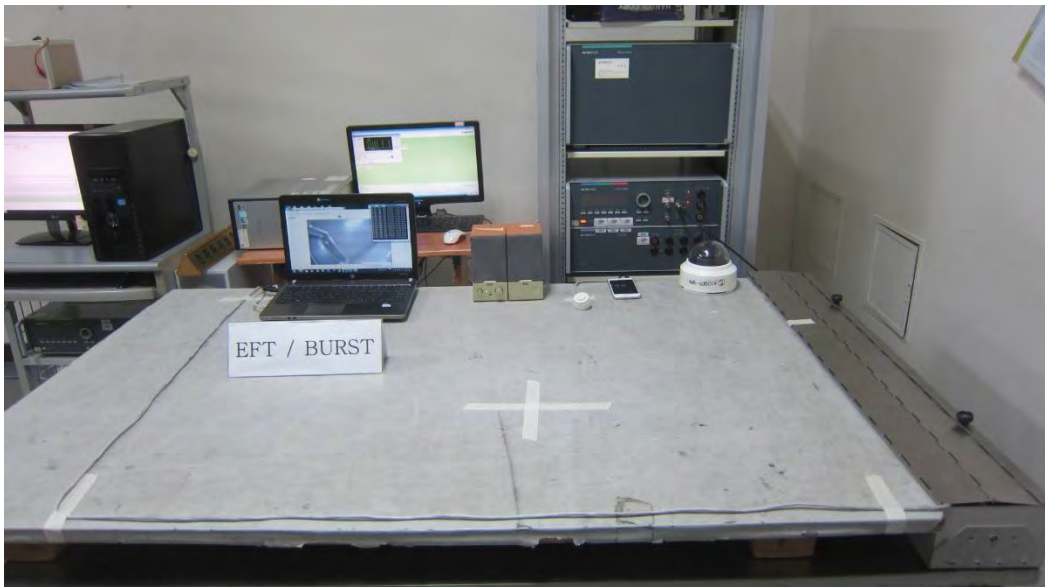

This report shall not be reproduced except in full, without the written approval of KES Co., Ltd.
The results shown in this test report refer only to the sample(s) tested unless otherwise stated.

- PoE Mode

N/A

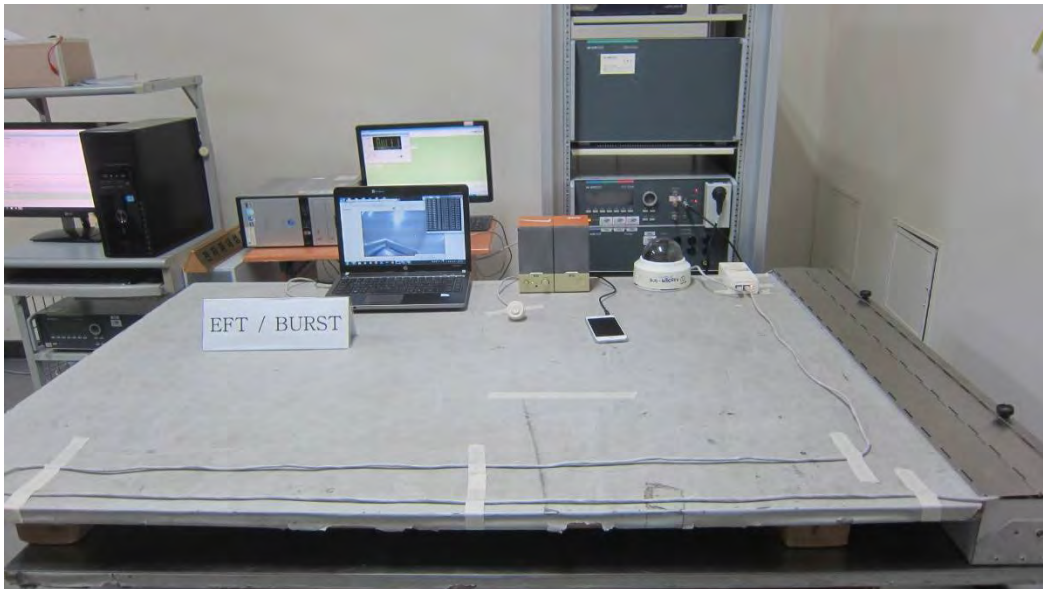

This report shall not be reproduced except in full, without the written approval of KES Co., Ltd.
The results shown in this test report refer only to the sample(s) tested unless otherwise stated.

Surge Transients

- DC 12 V Mode



This report shall not be reproduced except in full, without the written approval of KES Co., Ltd.
The results shown in this test report refer only to the sample(s) tested unless otherwise stated.

- PoE Mode

N/A



This report shall not be reproduced except in full, without the written approval of KES Co., Ltd.
The results shown in this test report refer only to the sample(s) tested unless otherwise stated.

Conducted Disturbance

- DC 12 V Mode



This report shall not be reproduced except in full, without the written approval of KES Co., Ltd.
The results shown in this test report refer only to the sample(s) tested unless otherwise stated.

- PoE Mode

N/A



This report shall not be reproduced except in full, without the written approval of KES Co., Ltd.
The results shown in this test report refer only to the sample(s) tested unless otherwise stated.



KES Co., Ltd.

C-3701, Simin-daero 365-40,
Dongan-gu, Anyang-si, Gyeonggi-do, 14057, Korea
Tel: +82-31-425-6200 / Fax: +82-31-424-0450
www.kes.co.kr

Test report No.:
KES-E1-16T0680
Page (76) of (82)

Voltage Dips and Short Interruptions

N/A

This report shall not be reproduced except in full, without the written approval of KES Co., Ltd.
The results shown in this test report refer only to the sample(s) tested unless otherwise stated.

EUT External Photographs

(Top)



(Bottom)



This report shall not be reproduced except in full, without the written approval of KES Co., Ltd.
The results shown in this test report refer only to the sample(s) tested unless otherwise stated.

EUT Internal Photographs

(Internal View)



This report shall not be reproduced except in full, without the written approval of KES Co., Ltd.
The results shown in this test report refer only to the sample(s) tested unless otherwise stated.

EUT Internal View – Main board

(Top)



(Bottom)



This report shall not be reproduced except in full, without the written approval of KES Co., Ltd.
The results shown in this test report refer only to the sample(s) tested unless otherwise stated.

EUT Internal View – Sub board

(Top)



(Bottom)



This report shall not be reproduced except in full, without the written approval of KES Co., Ltd.
The results shown in this test report refer only to the sample(s) tested unless otherwise stated.

EUT Internal View – Lens

(Top)



(Bottom)



This report shall not be reproduced except in full, without the written approval of KES Co., Ltd.
The results shown in this test report refer only to the sample(s) tested unless otherwise stated.

Label and Location



NETWORK CAMERA

Model No : XND-6080VP

Manufacturer : Hanwha Techwin (Tianjin) Co.,Ltd.

Made in of China

