

# EU Declaration of Conformity

# SAMSUNG



***We hereby declare that the product***

Type of equipment : NETWORK CAMERA  
Brand Name / Trade Mark : SAMSUNG  
Model number : XNO-6080RP  
Variant Model : -

***satisfies all the technical regulations applicable to the product within the scope of Council Directives 2014/30/EU***

EN 55022:2010 : Limits and methods of measurement of radio disturbance characteristics of information technology equipment  
EN 50581:2012 : Technical documentation for the assessment of electrical and electronic products with respect to the restriction of hazardous substances  
EN 50130-4:2011+A1:2014 : Product family standard: Immunity requirements for components of fire, intruder and social alarm systems  
EN 61000-3-2:2014 : Limits – Limits for harmonic current emissions (equipment input current  $\leq 16$  A per phase)  
EN 61000-3-3:2013 : Limitation of voltage changes, voltage fluctuations and flicker in public low-voltage supply systems, for equipment with rated current  $\leq 16$  A per phase and not subject to conditional connection  
EN 61000-4-2:2009 : Electrostatic discharge immunity test  
EN 61000-4-3:2006+A2:2010 : Radiated, radio-frequency, electromagnetic field immunity test  
EN 61000-4-4:2012 : Electrical fast transient/burst immunity test  
EN 61000-4-5:2014 : Surge immunity test  
EN 61000-4-6:2014 : Immunity to conducted disturbances, induced by radio-frequency fields  
EN 61000-4-11:2004 : Voltage dips, short interruptions and voltage variations immunity tests

***All essential testing suites have been carried out.***

Manufacturer : Tianjin Samsung Techwin Opto-Electronic Co., Ltd.  
Manufacturer address : No.11 Weiliu Rd, Micro-Electronic Industrial Park, TEDA, Tianjin, 300385, People's Republic of China  
Telephone / Fax : 82-02-729-2900 / 82-02-729-2904 (www.hanwhatechwin.com)  
Applicant : Hanwha Techwin Co., Ltd.  
Applicant address : 1204, Changwon-daero, Seongsan-gu, Changwon-si, Gyeongsangnam-do, Korea

***This declaration is issued under the sole responsibility of the manufacturer and his authorised representative.***

Authorized signatory

Name / Title : Jei Soon, Kang / Principal Research Engineer  
Date of issue : Dec. 06, 2016



# EMC TEST REPORT For CE

Test Report No. : KES-E1-16T0613  
Date of Issue : Dec, 06, 2016  
Product name : NETWORK CAMERA  
Model/Type No. : XNO-6080RP  
Variant Model : -  
Applicant : Hanwha Techwin Co., Ltd.  
Applicant Address : 1204, Changwon-daero, Seongsan-gu, Changwon-si,  
Gyeongsangnam-do, Korea  
Manufacturer : Tianjin Samsung Techwin Opto-Electronic Co.,Ltd.  
Manufacturer Address : No.11 Weiliu Rd, Micro-Electronic Industrial  
Park, TEDA, Tianjin, 300385, People's Republic of China  
Date of Receipt : Nov, 23, 2016  
Test date : Dec, 02, 2016 - Dec, 05, 2016  
Test Results :  **In Compliance**       **Not in Compliance**

Tested by

Jin Bae Lee  
EMC Test Engineer

Reviewed by

Dong-Hun, Jang  
EMC Technical Manager



## REPORT REVISION HISTORY

Date	Test Report No.	Revision History
Dec. 06, 2016	KES-E1-16T0613	Issued

***This report shall not be reproduced except in full, without the written approval of KES Co., Ltd. This document Jun be altered or revised by KES Co., Ltd. personnel only, and shall be noted in the revision section of the document. Any alteration of this document not carried out by KES Co., Ltd. will constitute fraud and shall nullify the document.***

This report shall not be reproduced except in full, without the written approval of KES Co., Ltd.  
The results shown in this test report refer only to the sample(s) tested unless otherwise stated.

---

## TABLE OF CONTENTS

1.0	General Product Description .....	4
1.1	Test Voltage & Frequency .....	7
1.2	Variant Model Differences.....	7
1.3	Device Modifications .....	7
1.4	Equipment Under Test.....	7
1.5	Support Equipments.....	7
1.6	External I/O Cabling.....	8
1.7	E.U.T Operating Mode(s).....	9
1.8	Configuration.....	10
1.9	Calibration Details of Equipment Used for Measurement.....	12
1.10	Test Facility .....	12
1.11	Laboratory Accreditations and Listings .....	12
2.0	Test Regulations.....	13
2.1	Conducted Emissions at Mains Power Ports.....	15
2.2	Conducted Emissions at Telecommunication Ports .....	16
2.3	Radiated Electric Field Emissions(Below 1 GHz) .....	17
2.4	Radiated Electric Field Emissions(Above 1 GHz).....	18
2.5	Harmonic Current Emissions.....	19
2.6	Voltage Fluctuations and Flicker .....	20
3.0	Criteria for compliance.....	21
3.1	Electrostatic Discharge.....	23
3.2	Radiated Electric Field Immunity .....	27
3.3	Electrical Fast Transients/Bursts .....	30
3.4	Surge Transients.....	33
3.5	Conducted Disturbance.....	37
3.6	Voltage Dips and Short Interruptions.....	41
APPENDIX A	– TEST DATA.....	43
	Conducted Emissions at Mains Power Ports.....	43
	Conducted Emissions at Telecommunication Ports .....	45
	Radiated Electric Field Emissions(Below 1 GHz) .....	51
	Radiated Electric Field Emissions(Above 1 GHz).....	53
	Harmonic Current Emissions and Voltage Fluctuations and Flicker .....	65
	Test Setup Photos and Configuration .....	68
	Conducted Voltage Emissions .....	68
	Conducted Telecommunication Emissions .....	69
	Radiated Electric Field Emissions(Below 1 GHz) .....	72
	Radiated Electric Field Emissions(Above 1 GHz).....	75
	Harmonic Current Emissions and Voltage Fluctuations and Flicker .....	78
	Electrostatic Discharge .....	78
	Radiated Electric Field Immunity .....	80
	Electrical Fast Transients/Bursts.....	82
	Surge Transients.....	85
	Conducted Disturbance.....	87
	Voltage Dips and Short Interruptions.....	90
	EUT External Photographs.....	91
	EUT Internal Photographs .....	92



## 1.0 General Product Description

### Main Specifications of E.U.T are:

<b>Video</b>	
Imaging Device	1/2.8" 2M CMOS (IMX291)
Total Pixels	1945(H) x 1109(V) 2.16M
Effective Pixels	1945(H) x 1097(V) 2.13M
Scanning System	Progressive Scan
Min. Illumination	Color : 0.03 lux (TBD) B/W : 0 Lux (IR LED On)
S / N Ratio	50dB
Video Out	CVBS : 1.0 Vp-p / 75Ω composite, 720x480(N), 720x576(P), for installation USB : Micro USB type B, 1920 x 1080(TBD), for installation
<b>Lens</b>	
Focal Length (Zoom Ratio)	2.8~12mm(4.3x) motorized varifocal
Max. Aperture Ratio	1.4(Wide) ~ 3.6(Tele)
Angular Field of View	H: 119.5°, V: 62.8°, D: 142.1° H: 27.9°, V: 15.7°, D: 32.0°
Min. Object Distance	0.5m (1.64ft)
Focus Control	Simple focus(Motorized V/F) / Manual, Remote control via network (Manual, Simple focus)
Lens Type	DC Auto Iris, P-iris
Mount Type	Board-in type
<b>Pan / Tilt / Rotate</b>	
Pan / Tilt / Rotate range	
<b>Operational</b>	
IR LED	4EA
Viewable Length	50m(164.04ft)
Camera Title	Off / On (Displayed up to 55 characters) - W/W : English/Numeric/Special Characters - China : English/Numeric/Special/Chinese Characters - Common : Multi-line (Max 6), Color (Grey/Green/Red/Blue/Black/White), Transparency, Auto Scale by Resolution
Day & Night	Auto (ICR) / Color / B/W / External / Schedule
Backlight Compensation	Off / BLC / HLC(Masking/Dimming), WDR(Seamless transition TBD)
Wide Dynamic Range	150dB(TBD)
Contrast Enhancement	SSDR (Off / On)
Digital Noise Reduction	SSNR5 (2D+3D Noise Filter) (Off / On)
Digital Image Stabilization	Off / On
Defog	Auto(input from fog detection) / Manual / Off
Motion Detection	Yes(8ea, 4point Polygonal zones)
Privacy Masking	Off / On (32ea, polygonal zones) - Color : Grey/Green/Red/Blue/Black/White - Mosaic ※ Zoom ratio option for mask mode (TBD)
Gain Control	Off / Low / Middle / High
White Balance	ATW / AWC / Manual / Indoor / Outdoor((included Mercury & Sodium)
Contrast	level adjustment
LDC	On/Off (5 levels with Min/Max)
Electronic Shutter Speed	Minimum / Maximum / Anti flicker (2 ~ 1/12,000sec →TBD)
Digital PTZ	24X, 'Digital PTZ(Preset, Group)

This report shall not be reproduced except in full, without the written approval of KES Co., Ltd.  
The results shown in this test report refer only to the sample(s) tested unless otherwise stated.



**KES Co., Ltd.**

C-3701, Simin-daero 365-40,  
 Dongan-gu, Anyang-si, Gyeonggi-do, 14057, Korea  
 Tel: +82-31-425-6200 / Fax: +82-31-424-0450  
 www.kes.co.kr

Test report No.:  
 KES-E1-16T0613  
 Page (5) of (99)

Flip / Mirror	Flip : On/Off Mirror : On/Off Hallway view : 90°/270°
Intelligent Video & Audio Analytics	Tampering, Loitering, Directional Detection, Defocus Detection, Fog&Dust Detection, Virtual Line, Enter/Exit, Appear / Disappear, Audio Detection, Motion Detection, Digital Auto Tracking, Sound Classification
Alarm I/O	Input 1ea / Output 1ea
Remote Control Interface	-
RS-485 Protocol	-
Alarm Triggers	Alarm Input, Motion Detection, Intelligent Video Analytics, Network Disconnect
Alarm events	File upload via FTP, E-Mail Notification via E-Mail local storage(SD/SDHC/SDXC) or NAS recording at Event Triggers External output DPTZ preset
Audio In	Selectable (Mic IN/Line IN), Supply voltage: 2.5VDC(4mA), Input impedance: approx. 2K Ohm
Audio out	Line out, Max output level: 1 Vrms
Fan / Heater	-
Pixel Counter	Support
<b>Network</b>	
Ethernet	RJ-45 (10/100BASE-T)
Video Compression Format	H.265/H.264 (MPEG-4 Part 10/AVC) : Main/Baseline/High , Motion JPEG
Resolution	1920x1080, 1280x1024, 1280x960, 1280x720, 1024x768, 800x600, 800x450, 720x576, 640x480, 640x360, 320x240, 320x180
Max. Framerate	H.265/H.264 : Max. 60fps at all resolutions Motion JPEG : Max. 30fps
Smart Codec	Manual Mode (area-based : 5EA)
Video Quality Adjustment	H.264/H.265 : Target Bitrate Level Control MJPEG : Target Bitrate Level Control
Bitrate Control Method	H.264/H.265 : CBR or VBR, ※ WiseStream 별도항목으로 분리 MJPEG : VBR
Streaming Capability	Multiple Streaming (Up to 10 Profiles)
Audio Compression Format	G.711 u-law /G.726 Selectable G.726 (ADPCM) 8KHz, G.711 8KHz G.726 : 16Kbps, 24Kbps, 32Kbps, 40Kbps AAC-LC : 48Kbps at 8/16/32/48KHz
Audio Communication	Bi-directional (2-Way)
IP	IPv4, IPv6
Protocol	TCP/IP, UDP/IP, RTP(UDP), RTP(TCP), RTCP,RTSP, NTP, HTTP, HTTPS, SSL/TLS, DHCP, PPPoE, FTP, SMTP, ICMP, IGMP, SNMPv1/v2c/v3(MIB-2), ARP, DNS, DDNS, QoS, PIM-SM, UPnP, Bonjour
Security	HTTPS(SSL) Login Authentication Digest Login Authentication IP Address Filtering User access Log 802.1X Authentication (EAP-TLS, EAP-LEAP) - Streaming Encryption 기능구현
Streaming Method	Streaming Method

This report shall not be reproduced except in full, without the written approval of KES Co., Ltd.  
 The results shown in this test report refer only to the sample(s) tested unless otherwise stated.



**KES Co., Ltd.**

C-3701, Simin-daero 365-40,  
 Dongan-gu, Anyang-si, Gyeonggi-do, 14057, Korea  
 Tel: +82-31-425-6200 / Fax: +82-31-424-0450  
 www.kes.co.kr

Test report No.:  
 KES-E1-16T0613  
 Page (6) of (99)

Max. User Access	20 users at Unicast Mode(TBD)
Edge Storage	SD/SDHC/SDXC 2slot (up to 512 GB) - Continuous recording(1'st slot to 2'nd slot) - (TBD) Redundant recording - Motion Images recorded in the SD/SDHC/SDXC memory card can be downloaded. NAS(Network Attached Storage) Local PC for Instant Recording
Application Programming Interface	ONVIF Profile S/G SUNAPI(HTTP API) Open Platform ※ SVNP 1.2 삭제 (구 기종 NVR 변경점 대응)
Webpage Language	English, Korean, Chinese, French, Italian, Spanish, German, Japanese, Russian, Swedish, Danish, Portuguese, Czech, Polish, Turkish, Rumanian, Serbian, Dutch, Croatia, Hungary, Greek, Norsk, Finnish
Web Viewer	Supported OS: Windows 7, 8, 10, Mac OS X 10.8, 10.9, 10.10, 10.11 <b>Non-plugin Webviewer</b> Supported Browser: Google Chrome 47, MS Edge 20 Support Codec : Video : H.264, MJPEG (MAX 1M 15FPS) Audio : G.711 <b>Plug-in Webviewer</b> Supported Browser : MS Explore 11 , Mozilla Firefox 43 , Apple Safari 9 * Mac OS X only
Central Management Software	SmartViewer, SSM
<b>Environmental</b>	
Operating Temperature / Humidity	-40°C ~ +55°C (-40°F ~ +131°F) / Less than 90% RH
Storage Temperature / Humidity	-50°C ~ +60°C (-58°F ~ +140°F) / Less than 90% RH
Ingress Protection	<b>IP67</b> , IP66, NEMA 4X
Vandal Resistance	IK10
<b>Electrical</b>	
Input Voltage / Current	24VAC ± 10%, 12VDC ± 10%, PoE(IEEE802.3af)
Power Consumption	TBD
<b>Mechanical</b>	
Color / Material	Dark gray / Aluminum
Dimension (WxHxD)	TBD
Weight	TBD

This report shall not be reproduced except in full, without the written approval of KES Co., Ltd.  
 The results shown in this test report refer only to the sample(s) tested unless otherwise stated.



## 1.1 Test Voltage & Frequency

Unless indicated otherwise on the individual data sheet or test results, the test voltage and frequency was as indicated below.

Voltage  220 Vac  230 Vac  24 Vac  12 Vdc  PoE  
Frequency  50 Hz  60 Hz  Hz

## 1.2 Variant Model Differences

Not applicable

## 1.3 Device Modifications

Not applicable

## 1.4 Equipment Under Test

Description	Model Number	Serial Number	Manufacturer	Remarks
NETWORK CAMERA	XNO-6080RP	-	Tianjin Samsung Techwin Opto-Electronic Co.,Ltd.	E.U.T

## 1.5 Support Equipments

Description	Model Number	Serial Number	Manufacturer	Remarks
POE Adapter	PD-3001GC/AC	RD9356082016964 200	Power Dsine	-
Notebook	X56K	HN11N5151FJ0045 W	HANSUNG	-
Notebook Adapter	A12-120P1A	F180271552011758	CHICONY POWER TECHNOLOGY CO.,LTD.	-
Phone	A1530	-	APPLE	-
MIC	CMK-303	-	CAMAC	1.7 m
Speaker	BR10000A CUVE	-	BEIJING EDIFIER HI-TECH GROUP.	1.6 m
Alarm	-	-	-	-
SD card	-	-	SanDisk	16 GB



## 1.6 External I/O Cabling

- AC 24 V Mode

Start		END		Cable Spec.	
Description	I/O Port	Description	I/O Port	Length	Shield
NETWORK CAMERA (E.U.T)	RJ-45	Notebook	RJ-45	3.0	U
	7 Pin	MIC	3.5 mm	1.7	U
		Speaker	3.5 mm	1.6	U
		Alarm	2 pin	3.0	U
	Slot	SD card	Slot	-	-
Notebook	Audio in	Phone	Audio out	1.7	U

- DC 12 V Mode

Start		END		Cable Spec.	
Description	I/O Port	Description	I/O Port	Length	Shield
NETWORK CAMERA (E.U.T)	RJ-45	Notebook	RJ-45	3.0	U
	7 Pin	MIC	3.5 mm	1.7	U
		Speaker	3.5 mm	1.6	U
		Alarm	2 pin	3.0	U
	Slot	SD card	Slot	-	-
Notebook	Audio in	Phone	Audio out	1.7	U

This report shall not be reproduced except in full, without the written approval of KES Co., Ltd.  
The results shown in this test report refer only to the sample(s) tested unless otherwise stated.

- PoE Mode

Start		END		Cable Spec.	
Description	I/O Port	Description	I/O Port	Length	Shield
NETWORK CAMERA (E.U.T)	RJ-45 (POE)	POE Adapter	RJ-45 (POE)	3.0	U
	7 Pin	MIC	3.5 mm	1.7	U
		Speaker	3.5 mm	1.6	U
		Alarm	2 pin	3.0	U
	Slot	SD card	Slot	-	-
Notebook	Audio in	Phone	Audio out	1.7	U
	RJ-45 (DATA)	POE Adapter	RJ-45 (DATA)	3.0	U

\* Unshielded=U, Shielded=S

## 1.7 E.U.T Operating Mode(s)

Test mode	Normal operating
	E.U.T Monitoring , Ping test, 1 kHz

E.U.T Test operating S/W		
Name	Version	Manufacture Company
SmartViewer	-	Hanwha Techwin Co., Ltd.

This report shall not be reproduced except in full, without the written approval of KES Co., Ltd.  
The results shown in this test report refer only to the sample(s) tested unless otherwise stated.

## 1.8 Configuration

■ AC 24 V Main  
 □ DC 12 V Main

- AC 24 V Mode

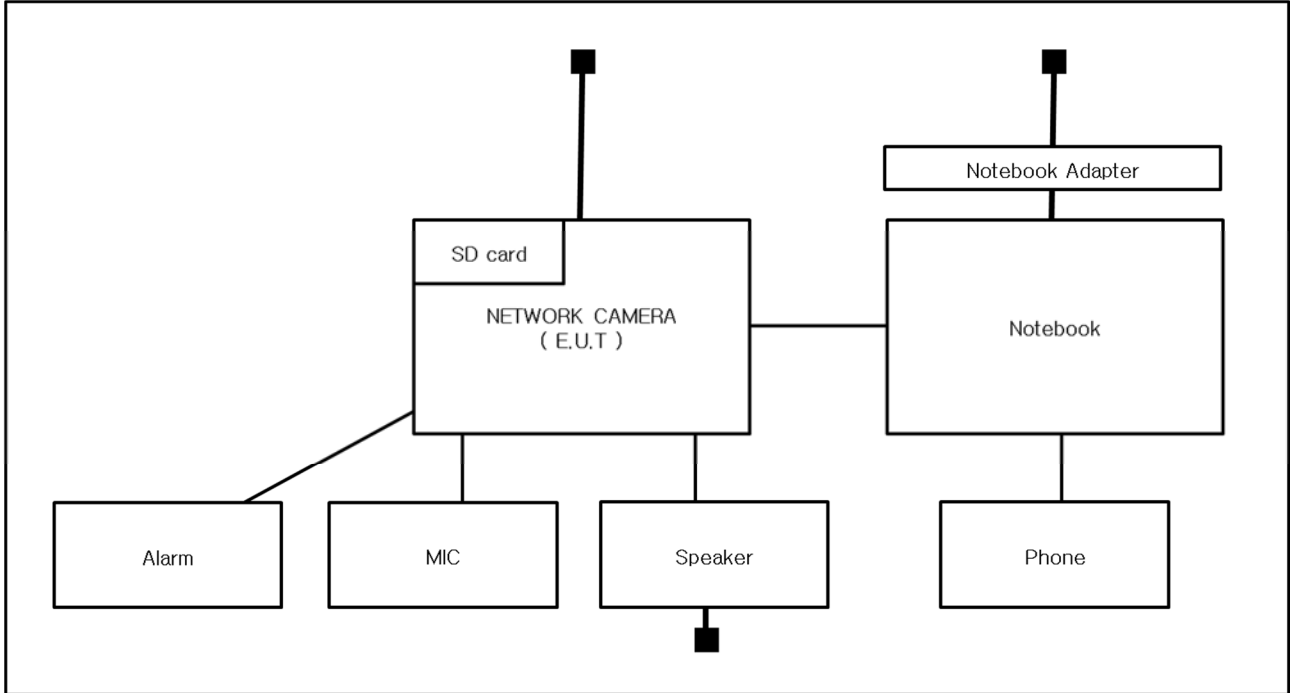

- DC 12 V Mode

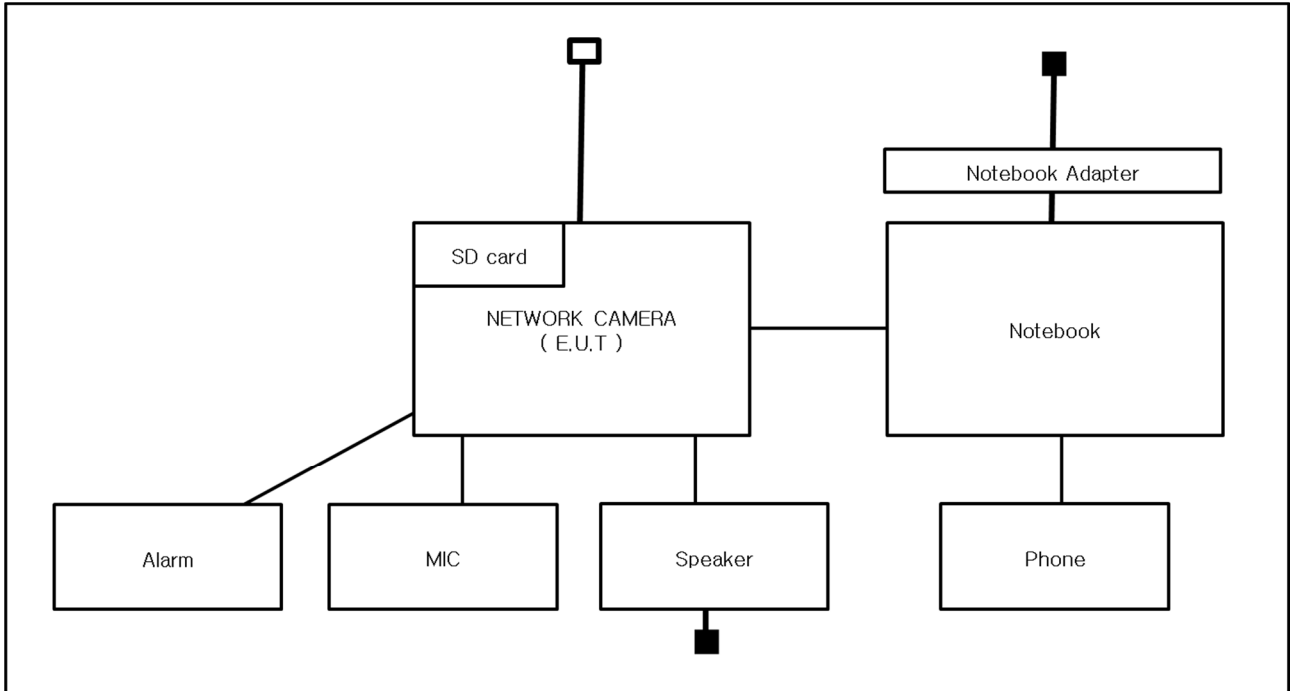

This report shall not be reproduced except in full, without the written approval of KES Co., Ltd.  
 The results shown in this test report refer only to the sample(s) tested unless otherwise stated.

- PoE Mode

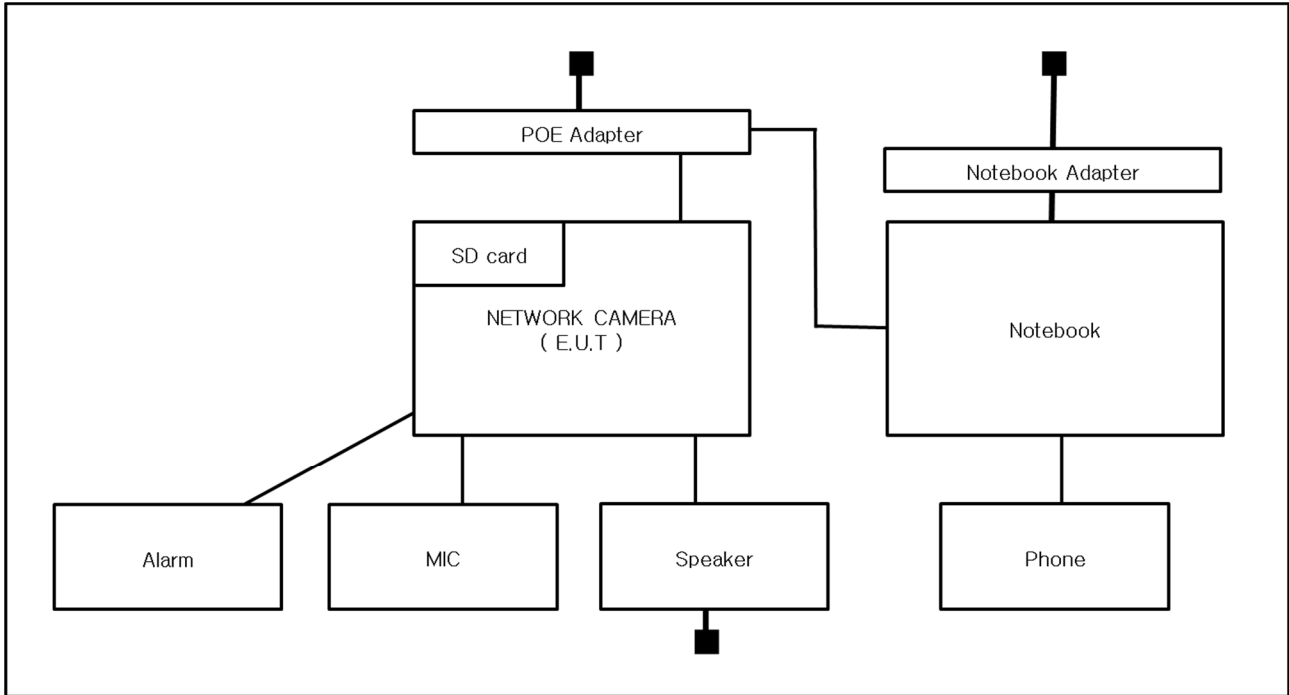

This report shall not be reproduced except in full, without the written approval of KES Co., Ltd.  
The results shown in this test report refer only to the sample(s) tested unless otherwise stated.







## 1.9 Calibration Details of Equipment Used for Measurement

Test equipment and test accessories are calibrated on regular basis. The maximum time between calibrations is one year or what is recommended by the manufacturer, whichever is less.

## 1.10 Test Facility

The measurement facility is located at 473-21 Gayeo-ro, Yeosu-si, Gyeonggi-do, 12658, Korea. The sites are constructed in conformance with the requirements of ANSI C63.4 and CISPR Publication 22.

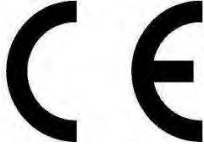
## 1.11 Laboratory Accreditations and Listings

Country	Agency	Scope of Accreditation	Logo
USA	FCC	3 & 10 meter Open Area Test Sites and one conducted site to perform FCC Part 15/18 measurements.	
JAPAN	VCCI	Mains Ports Conducted Interference Measurement, Telecommunication Ports Conducted Disturbance Measurement and Radiation 10 meter site, Facility for measuring radiated disturbance above 1 GHz	 R-4308, C-4798, T-2311, G-914
KOREA	MSIP	EMI (10 meter Open Area Test Site and two conducted sites) Radio(3 & 10 meter Open Area Test Sites and one conducted site) EMS (ESD, RS, EFT/Burst, Surge, CS, Magnetic, Dips and interruptions)	 KR0100
Canada	IC	3 & 10 meter Open Area Test Sites and one conducted site	 4769B-1
Europe	CE	EMI (10 meter Open Area Test Site and two conducted sites) Radio(3 & 10 meter Open Area Test Sites and one conducted site) EMS (ESD, RS, EFT/Burst, Surge, CS, Magnetic, Dips and interruptions)	
International	KOLAS	EMI (10 meter Open Area Test Site and two conducted sites) Radio(3 & 10 meter Open Area Test Sites and one conducted site) EMS (ESD, RS, EFT/Burst, Surge, CS, Magnetic, Dips and interruptions)	

## 2.0 Test Regulations

The emissions tests were performed according to following regulations:

**EMC – Directive 2014/30/EU**

EN 61000-6-3:2011

EN 61000-6-1:2007

EN 61000-6-4:2007 +A1:2011

EN 61000-6-2:2005

EN 55011:2007 +A1:2010

Group 1  
 Class A

Group 2  
 Class B

EN 55014-1:2006 +A2:2011

EN 55014-2:1997 +A2:2008

EN 55015:2013

EN 61547:2009

EN 55022:2010

Class A

Class B

EN 55024:2010 +A1:2015

EN 50130-4:2011 +A1:2014

EN 61000-3-2:2014

EN 61000-3-3:2013

EN 61326-1:2013



- 
- |   |                                  |                                  |
|---|----------------------------------|----------------------------------|
| <input type="checkbox"/> <b>VCCI V-3 / 2015.04</b>            | <input type="checkbox"/> Class A | <input type="checkbox"/> Class B |
| <input type="checkbox"/> <b>AS/NZS CISPR22:2009 +A1:2010</b>  | <input type="checkbox"/> Class A | <input type="checkbox"/> Class B |
| <input type="checkbox"/> <b>47 CFR Part 15, Subpart B</b>     |                                  |                                  |
| <input type="checkbox"/> CISPR 22:2009 +A1:2010               | <input type="checkbox"/> Class A | <input type="checkbox"/> Class B |
| <input type="checkbox"/> ANSI C63.4-2009                      |                                  |                                  |
| <input type="checkbox"/> <b>IC Regulation ICES-003 : 2016</b> |                                  |                                  |
| <input type="checkbox"/> CAN/CSA CISPR 22-10                  | <input type="checkbox"/> Class A | <input type="checkbox"/> Class B |
| <input type="checkbox"/> ANSI C63.4-2014                      |                                  |                                  |
| <input type="checkbox"/> <b>RE- Directive 2014/53/EU</b>      |                                  |                                  |
| <input type="checkbox"/> EN 301 489-1 V1.9.2                  |                                  |                                  |
| <input type="checkbox"/> Equipment for fixed use              |                                  |                                  |
| <input type="checkbox"/> Equipment for vehicular use          |                                  |                                  |
| <input type="checkbox"/> Equipment for portable use           |                                  |                                  |
| <input type="checkbox"/> EN 301 489-3 V1.6.1                  |                                  |                                  |
| <input type="checkbox"/> EN 301 489-17 V2.2.1                 |                                  |                                  |
| <input type="checkbox"/> EN 60945:2002                        |                                  |                                  |

---

This report shall not be reproduced except in full, without the written approval of KES Co., Ltd.  
The results shown in this test report refer only to the sample(s) tested unless otherwise stated.

## 2.1 Conducted Emissions at Mains Power Ports

**Test Date**

Dec, 02, 2016

**Test Location**

Electro wave Shieldroom

**Test Equipment**

Used	Description	Model Number	Manufacturer	Serial Number	Cal. Due
<input checked="" type="checkbox"/>	EMI Test Receiver	ESR3	R & S	101783	05, 03, 2017
<input checked="" type="checkbox"/>	LISN	ENV216	R & S	101137	02, 04, 2017
<input checked="" type="checkbox"/>	LISN	ENV216	R & S	101786	05, 02, 2017
<input checked="" type="checkbox"/>	Electro wave Shieldroom	-	SEMITEC	-	-
<input checked="" type="checkbox"/>	EMI Test S/W	EMC32	R&S	9.12.00	-

**Test Conditions**Temperature: 16,5 °C  
Relative Humidity: 39,8 %**Frequency Range of Measurement**

150 kHz to 30 MHz

**Instrument Settings**

IF Band Width: 9 kHz

**Test Results**

The requirements are:

- PASS  
 NOT PASS  
 NOT APPLICABLE

**Remarks**See Appendix A for test data.



## 2.2 Conducted Emissions at Telecommunication Ports

### Test Date

Dec, 02, 2016

### Test Location

Electro wave Shieldroom

### Test Equipment

Used	Description	Model Number	Manufacturer	Serial Number	Cal. Due
<input checked="" type="checkbox"/>	EMI Test Receiver	ESR3	R&S	101783	05, 03, 2017
<input checked="" type="checkbox"/>	LISN	ENV216	R&S	101137	02, 04, 2017
<input checked="" type="checkbox"/>	LISN	ENV216	R&S	101786	05, 02, 2017
<input checked="" type="checkbox"/>	8-Wire ISN CAT3	CAT3 8158	Schwarzbeck Mess	8158-0019	04, 01, 2017
<input checked="" type="checkbox"/>	8-Wire ISN CAT5	CAT5 8158	Schwarzbeck Mess	8158-0030	04, 01, 2017
<input type="checkbox"/>	8-Wire ISN CAT6	NTFM 8158	Schwarzbeck Mess	8158-0029	08, 11, 2017
<input checked="" type="checkbox"/>	Electro wave Shieldroom	-	SEMITEC	-	-
<input checked="" type="checkbox"/>	EMI Test S/W	EMC32	R&S	9.12.00	-

### Test Conditions

Temperature: 16,5 °C  
Relative Humidity: 39,8 %

### Frequency Range of Measurement

150 kHz to 30 MHz

### Instrument Settings

IF Band Width: 9 kHz

### Test Results

The requirements are:

- PASS
- NOT PASS
- NOT APPLICABLE

### Remarks

See Appendix A for test data.

## 2.3 Radiated Electric Field Emissions(Below 1 GHz)

### Test Date

Dec, 03, 2016

### Test Location

Open Area Test Site #1       Open Area Test Site #2

### Test Equipment

Used	Description	Model Number	Manufacturer	Serial Number	Cal. Due
<input checked="" type="checkbox"/>	EMI TEST Receiver	ESR3	R&S	101781	05, 03, 2017
<input checked="" type="checkbox"/>	Trilog-Broadband ANT	VULB 9163	Schwarzbeck	9163-713	05, 15, 2017
<input checked="" type="checkbox"/>	Open Area Test Site	-	KES	-	-
<input checked="" type="checkbox"/>	Antenna Mast	-	DAEIL EMC	-	-
<input checked="" type="checkbox"/>	Turn Table	-	DAEIL EMC	-	-
<input checked="" type="checkbox"/>	EMI Test S/W	-	-	-	-

### Test Conditions

Temperature: 9,8 °C  
 Relative Humidity: 35,0 %

### Frequency Range of Measurement

30 MHz to 1 GHz

### Instrument Settings

IF Band Width: 120 kHz

### Test Results

The requirements are:

- PASS  
 NOT PASS  
 NOT APPLICABLE

### Remarks

See Appendix A for test data.

## 2.4 Radiated Electric Field Emissions(Above 1 GHz)

**Test Date**

Dec, 03, 2016

**Test Location**

Semi Anechoic Chamber #2

**Test Equipment**

Used	Description	Model Number	Manufacturer	Serial Number	Cal. Due
<input checked="" type="checkbox"/>	DOUBLE RIDGED HORN ANTENNA	SAS-571	A.H.SYSTEM,INC	781	05, 07, 2017
<input checked="" type="checkbox"/>	EMI Test Receiver	ESU26	R&S	100552	04, 24, 2017
<input checked="" type="checkbox"/>	Broadband Coaxial Preampifier	BBV 9718	Schwarzbeck Mess - Elektronik	9718-246	10, 14, 2017
<input checked="" type="checkbox"/>	Semi Anechoic Chamber #2	-	SEMITEC	-	-
<input checked="" type="checkbox"/>	Antenna Mast	-	AUDIX	-	-
<input checked="" type="checkbox"/>	Turn Table	-	AUDIX	-	-
<input checked="" type="checkbox"/>	EMI Test S/W	e3	AUDIX	8.083b	-

**Test Conditions**

Temperature: 17,8 °C

Relative Humidity: 47,2 %

**Frequency Range of Measurement**

1 GHz to 6 GHz

**Instrument Settings**

IF Band Width: 1 MHz

**Test Results**

The requirements are:

- PASS  
 NOT PASS  
 NOT APPLICABLE

**Remarks**See Appendix A for test data.



## 2.5 Harmonic Current Emissions

### Test Date

N/A

### Test Location

Electro wave Shieldroom

### Test Equipment

Used	Description	Model Number	Manufacturer	Serial Number	Cal. Due
<input type="checkbox"/>	AC Source	ACS 500 N	EM TEST	V1024106760	08, 08, 2017
<input type="checkbox"/>	Digital Power Analyzer	DPA 500 N	EM TEST	V1024106759	08, 08, 2017
<input type="checkbox"/>	EMI Test S/W	dpa.control	EM TEST AG	5.4.8.0	-

### Test Conditions

Temperature: °C

Relative Humidity: %

### Classification of Equipment for Harmonic Current Emissions

- Class A
- Class B
- Class C(Below 25 W)
- Class C(Above 25 W)
- Class D

### Test Results

The requirements are:

- PASS
- NOT PASS
- NOT APPLICABLE

### Remarks

N/A



## 2.6 Voltage Fluctuations and Flicker

### Test Date

N/A

### Test Location

Electro wave Shieldroom

### Test Equipment

Used	Description	Model Number	Manufacturer	Serial Number	Cal. Due
<input type="checkbox"/>	AC Source	ACS 500 N	EM test	V1024106760	08, 08, 2017
<input type="checkbox"/>	Digital Power Analyzer	DPA 500 N	EM test	V1024106759	08, 08, 2017
<input type="checkbox"/>	EMI Test S/W	dpa.control	EM TEST AG	5.4.8.0	-

### Test Conditions

Temperature: °C

Relative Humidity: %

### Test Results

The requirements are:

- PASS
- NOT PASS
- NOT APPLICABLE

### Remarks

N/A

### 3.0 Criteria for compliance

Criteria for compliance was based on the following guidelines:  
EN 50130-4:2011 +A1:2014 Alarm systems-Part 4: Electromagnetic compatibility Product family standard: Immunity requirements for components of fire, intruder and social alarm systems

The variety and the diversity of the apparatus within the scope of this document makes it difficult to define precise criteria for the evaluation of the immunity test results.

If as a result of the application of the tests defined in this standard, the apparatus becomes dangerous or unsafe then the apparatus shall be deemed to have failed the test.

A functional description and a definition of performance by the manufacture and noted in the test report, based on the following criteria:

#### Electrostatic discharge

There shall be no damage, malfunction or change of status due to the conditioning.

Flickering of an indicator during the application of discharge is permissible, providing that is no residual change in the EUT or any change in outputs, which could be interpreted by associated equipment as a change.

#### Radiated electromagnetic fields

There shall be no damage, malfunction or change of status due to the conditioning.

Flickering of an indicator during the application of discharge is permissible, providing which could be interpreted by associated equipment as a change, and no such

Flickering of indicators occurs at a field strength of 3 V/m.

For components of CCTV systems, where the picture is allowed at 10 V/m, providing.

(a) there is no permanent damage or change to EUT

(e.g. no corruption of memory or changes to programmable setting etc.)

(b) at 3 V/m, any deterioration of the picture is so minor that the system could still be used; and

(c) there is no observable deterioration of the picture at 1 V/m.

**Fast transient burst / slow high energy voltage surge**

There shall be no damage, malfunction or change of status due to the conditioning.

Flickering of an indicator during the application of discharge is permissible, providing

That there is no residual is permissible, providing that there is no residual change in the EUT or any change in outputs, which could be interpreted by associated equipment as a change.

**Conducted RF immunity**

There shall be no damage, malfunction or change of status due to the conditioning.

Flickering of an indicator during the application of discharge is permissible, providing

That there is no residual is permissible, providing that there is no residual change in the EUT or any change in outputs, which could be interpreted by associated equipment as a change,  
and no such flickering of indicators oeuvres at  $U = 130 \text{ dB}\mu\text{V}$ .

For component of CCTV systems, where the status is monitored by observing the TV picture,  
then deterioration of the picture is allowed at  $U = 140 \text{ dB}\mu\text{V}$ , providing:

(a) there is no permanent damage or change to the EUT

(e.g. no corruption of memory or changes to programmable settings etc.)

(b) at  $U = 130 \text{ dB}\mu\text{V}$ , any deterioration of the picture is so minor that the system could  
still be used; and

(c) there in no observable deterioration of the picture at  $U = 120 \text{ dB}\mu\text{V}$ .

**Voltage dip/interruption / Voltage variation**

There shall be no damage, malfunction or change of status due to the conditioning.

Flickering of an indicator during the conditioning is permissible, providing that there is no residual

change in the EUT or any change in outputs, which could be interpreted by associated equipment

as a change. The EUT shall meet the acceptance criteria for the functional test, after the conditioning.

### 3.1 Electrostatic Discharge

**Reference Standard**

EN 61000-4-2:2009

**Test Date**

Dec, 05, 2016

**Test Location**

EMS-ESD: Electro wave Shieldroom

**Test Equipment**

Used	Description	Model Number	Manufacturer	Serial Number	Cal. Due
<input checked="" type="checkbox"/>	ESD SIMULATOR	ESS-2000	Noise Ken	ESS05X4620	02, 24, 2017
<input checked="" type="checkbox"/>	HCP	-	Noise Ken	-	-
<input checked="" type="checkbox"/>	VCP	-	Noise Ken	-	-
<input checked="" type="checkbox"/>	EMS Test S/W	N/A	N/A	N/A	-

**Test Conditions**

Temperature: 17,5 °C  
Relative Humidity: 49,3 %  
Atmospheric Pressure: 100,6 kPa

**Test Specifications**

Discharge Factor: ≥ 1 s  
  
Discharge Impedance: 330 ohm / 150 pF  
  
Kind of Discharge: Air, Contact (direct and indirect)  
  
Polarity: Positive and Negative  
Number of Discharge: 10 at all locations for Air discharge  
10 at all locations for Contact discharge

Discharge Voltage:	<b>Contact</b>	<b>Air</b>	<b>HCP</b>	<b>VCP</b>
	<input type="checkbox"/> 2 kV	<input checked="" type="checkbox"/> 2 kV	<input type="checkbox"/> 2 kV	<input type="checkbox"/> 2 kV
	<input type="checkbox"/> 4 kV	<input checked="" type="checkbox"/> 4 kV	<input type="checkbox"/> 4 kV	<input type="checkbox"/> 4 kV
	<input checked="" type="checkbox"/> 6 kV	<input type="checkbox"/> 6 kV	<input checked="" type="checkbox"/> 6 kV	<input checked="" type="checkbox"/> 6 kV
	<input type="checkbox"/> 8 kV	<input checked="" type="checkbox"/> 8 kV	<input type="checkbox"/> 8 kV	<input type="checkbox"/> 8 kV
	<input type="checkbox"/> 15 kV	<input type="checkbox"/> 15 kV	<input type="checkbox"/> 15 kV	<input type="checkbox"/> 15 kV

Notes: HCP: Horizontal coupling plane  
VCP: Vertical coupling plane

Required Performance Criteria:  Complied

This report shall not be reproduced except in full, without the written approval of KES Co., Ltd.  
The results shown in this test report refer only to the sample(s) tested unless otherwise stated.



**Location of Discharge:**

- AC 24 V Mode

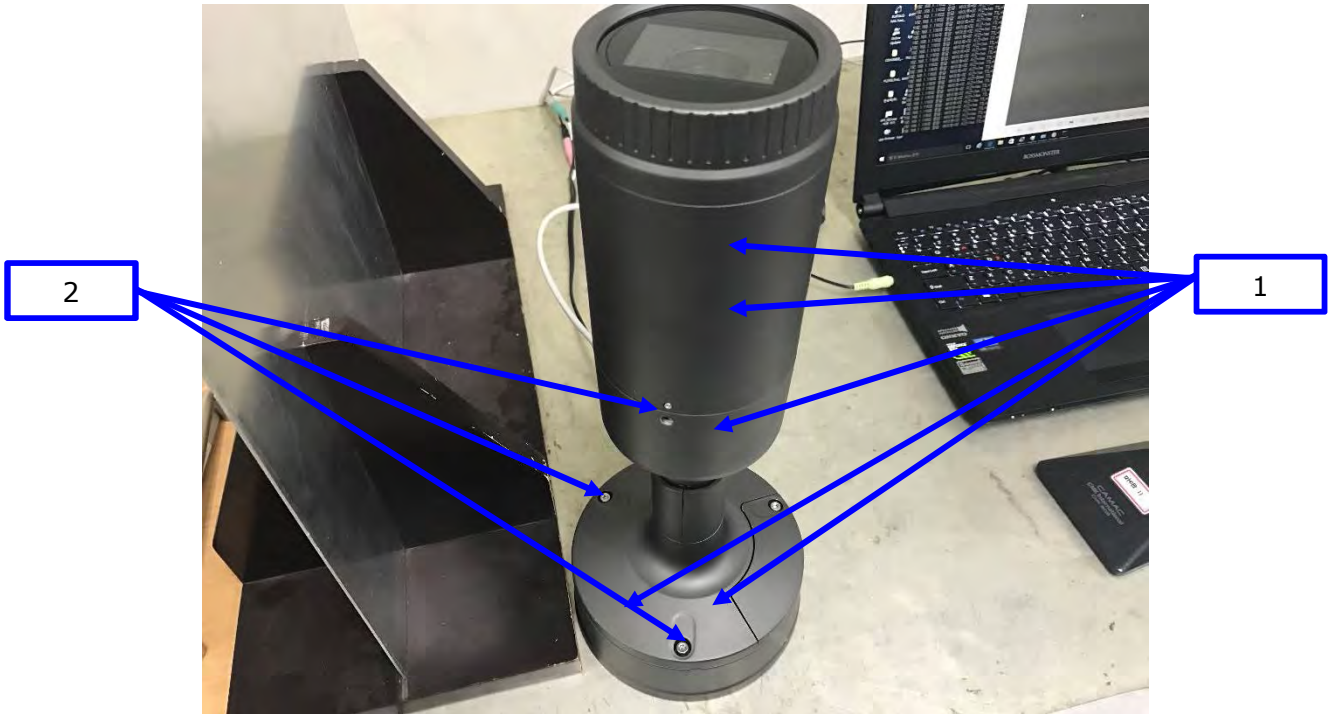
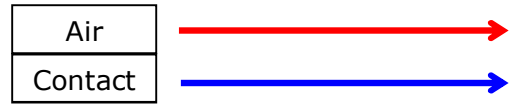

This report shall not be reproduced except in full, without the written approval of KES Co., Ltd.  
The results shown in this test report refer only to the sample(s) tested unless otherwise stated.

**Test Data**

## - AC 24 V Mode

## Indirect Discharge

No.	Test Point	Discharge Method	Observations	Remarks
1	HCP Contact	Contact Discharge	Complied	-
2	VCP Contact	Contact Discharge	Complied	-

## Direct Discharge

No.	Test Point	Discharge Method	Observations	Remarks
1	Inclosure	Contact Discharge	Complied	-
2	Screw	Contact Discharge	Complied	-

## - DC 12 V Mode

## Indirect Discharge

No.	Test Point	Discharge Method	Observations	Remarks
1	HCP Contact	Contact Discharge	Complied	-
2	VCP Contact	Contact Discharge	Complied	-

## Direct Discharge

No.	Test Point	Discharge Method	Observations	Remarks
1	Inclosure	Contact Discharge	Complied	-
2	Screw	Contact Discharge	Complied	-



- PoE Mode

Indirect Discharge

No.	Test Point	Discharge Method	Observations	Remarks
1	HCP Contact	Contact Discharge	Complied	-
2	VCP Contact	Contact Discharge	Complied	-

Direct Discharge

No.	Test Point	Discharge Method	Observations	Remarks
1	Inclosure	Contact Discharge	Complied	-
2	Screw	Contact Discharge	Complied	-

Note: "Blank" = Not performed

Observations:  
Complied - No degradation of function

**Test Results**

- PASS Required Performance Criteria
- NOT PASS Required Performance Criteria

**Remarks**

PASS Required Performance Criteria.

## 3.2 Radiated Electric Field Immunity

### Reference Standard

EN 61000-4-3:2006 +A2:2010

### Test Date

Dec, 04, 2016

### Test Location

EMS-RS:  Semi Anechoic Chamber #1       Semi Anechoic Chamber #2

### Test Equipment

Used	Description	Model Number	Manufacturer	Serial Number	Cal. Due
<input checked="" type="checkbox"/>	SIGNAL GENERATOR	SMB 100A	Rohde & Schwarz	108252	08, 08, 2017
<input checked="" type="checkbox"/>	BROADBAND AMPLIFIER	BBA100	Rohde & Schwarz	101239	08, 08, 2017
<input checked="" type="checkbox"/>	BROADBAND AMPLIFIER	100S1G6M1	AR	579931	08, 08, 2017
<input checked="" type="checkbox"/>	POWER METER	NRP2	Rohde & Schwarz	103475	08, 08, 2017
<input checked="" type="checkbox"/>	AVG POWER SENSOR	NRP-Z91	Rohde & Schwarz	102526	08, 08, 2017
<input checked="" type="checkbox"/>	AVG POWER SENSOR	NRP-Z91	Rohde & Schwarz	102527	08, 08, 2017
<input checked="" type="checkbox"/>	Stacked Log-Per. Antenna	STLP 9128 D	Schwarzbeck	9128D038	-
<input checked="" type="checkbox"/>	DIRECTIONAL COUPLER	KYDC-D1070-DX40	Kytelecom Co., Ltd.	KY150001	08, 08, 2017
<input checked="" type="checkbox"/>	Semi Anechoic Chamber #2	-	SEMITEC	-	-
<input checked="" type="checkbox"/>	EMS Test S/W	EMC32	R&S	9.12.00	-

### Test Conditions

Temperature: 16,6 °C  
Relative Humidity: 46,8 %  
Atmospheric Pressure: 101,3 kPa



### Test Specifications

Antenna Polarization: Horizontal & vertical unless indicated otherwise

Antenna Distance:  3 m

Field Strength:  1 V/m  3 V/m  
 10 V/m

Frequency Range:  80 MHz to 1 GHz  1,4 GHz to 2,7 GHz  
 80 MHz to 2,7 GHz

Modulation:  AM, 80 %, 1 kHz sine wave  
 PM, 1 Hz (0,5 s ON : 0,5 s OFF)

Frequency step:  1 % step

Dwell Time:  1 s  3 s

# of Sides Radiated:  4

Required Performance Criteria:  Complied

**Test Data**

- AC 24 V Mode

Side Exposed	Observations	
	Horizontal	Vertical
Front	Complied	Complied
Right	Complied	Complied
Back	Complied	Complied
Left	Complied	Complied

- DC 12 V Mode

Side Exposed	Observations	
	Horizontal	Vertical
Front	Complied	Complied
Right	Complied	Complied
Back	Complied	Complied
Left	Complied	Complied

- PoE Mode

Side Exposed	Observations	
	Horizontal	Vertical
Front	Complied	Complied
Right	Complied	Complied
Back	Complied	Complied
Left	Complied	Complied

Note: "Blank" = Not performed

Observations:  
 Complied – No degradation of function

**Test Results**

- PASS Required Performance Criteria
- NOT PASS Required Performance Criteria

**Remarks**

PASS Required Performance Criteria.

### 3.3 Electrical Fast Transients/Bursts

**Reference Standard**

EN 61000-4-4:2012

**Test Date**

Dec, 05, 2016

**Test Location**

EMS-EFT: Electro wave Shieldroom

**Test Equipment**

Used	Description	Model Number	Manufacturer	Serial Number	Cal. Due
<input checked="" type="checkbox"/>	Ultra Compact Simulator	UCS 500 N5	EM TEST	V0936105120	06, 27, 2017
<input checked="" type="checkbox"/>	Capacitive Coupling Clamp	HFK	EM TEST	070925	06, 27, 2017
<input checked="" type="checkbox"/>	Motor Variac	MV2616	EM TEST	V0936105123	06, 27, 2017
<input checked="" type="checkbox"/>	EMS Test S/W	iec.control	EM TEST AG	5.0.9.0	-

**Test Conditions**

Temperature: 18,2 °C  
Relative Humidity: 43,7 %  
Atmospheric Pressure: 101,5 kPa

**Test Specifications**

Pulse Amplitude & Polarity:  ± 1.0 kV  ± 2.0 kV  
(AC Power Lines)  ± 4.0 kV

Pulse Amplitude & Polarity:  ± 0.5 kV  ± 1.0 kV  
(Other supply / Signal Lines)  ± 2.0 kV

Burst Period:  300 ms  2 s

Repetition Rate:  5 kHz  100 kHz

Duration of Test Voltage:  ≥ 1 min

Required Performance Criteria:  Complied

This report shall not be reproduced except in full, without the written approval of KES Co., Ltd.  
The results shown in this test report refer only to the sample(s) tested unless otherwise stated.

**Test Data**

- AC 24 V Mode

Input a.c. power ports – Coupling/Decoupling Network used

Mode of Application	Observations	
	(+) Burst (kV)	(-) Burst (kV)
L – N	Complied	Complied

Input d.c. power ports – Coupling/Decoupling Network used

Mode of Application	Observations	
	(+) Burst (kV)	(-) Burst (kV)
-	-	-

Signal ports and telecommunication ports – Coupling Clamp used

Mode of Application	Observations	
	(+) Burst (kV)	(-) Burst (kV)
Alarm (2 Pin)	Complied	Complied
RJ-45	Complied	Complied

- DC 12 V Mode

Input a.c. power ports – Coupling/Decoupling Network used

Mode of Application	Observations	
	(+) Burst (kV)	(-) Burst (kV)
-	-	-

Input d.c. power ports – Coupling/Decoupling Network used

Mode of Application	Observations	
	(+) Burst (kV)	(-) Burst (kV)
L1 – L2	Complied	Complied

Signal ports and telecommunication ports – Coupling Clamp used

Mode of Application	Observations	
	(+) Burst (kV)	(-) Burst (kV)
Alarm (2 Pin)	Complied	Complied
RJ-45	Complied	Complied

This report shall not be reproduced except in full, without the written approval of KES Co., Ltd.  
 The results shown in this test report refer only to the sample(s) tested unless otherwise stated.



- PoE Mode

Input a.c. power ports – Coupling/Decoupling Network used

Mode of Application	Observations	
	(+) Burst (kV)	(-) Burst (kV)
-	-	-

Input d.c. power ports – Coupling/Decoupling Network used

Mode of Application	Observations	
	(+) Burst (kV)	(-) Burst (kV)
-	-	-

Signal ports and telecommunication ports – Coupling Clamp used

Mode of Application	Observations	
	(+) Burst (kV)	(-) Burst (kV)
Alarm (2 Pin)	Complied	Complied
RJ-45	Complied	Complied

Note: “Blank” = Not performed

Observations:  
 Complied – No degradation of function

**Test Results**

- PASS Required Performance Criteria
- NOT PASS Required Performance Criteria

**Remarks**

PASS Required Performance Criteria.



### 3.4 Surge Transients

**Reference Standard**

EN 61000-4-5:2014

**Test Date**

Dec, 05, 2016

**Test Location**

EMS-Surge: Electro wave Shieldroom

**Test Equipment**

Used	Description	Model Number	Manufacturer	Serial Number	Cal. Due
<input checked="" type="checkbox"/>	Ultra Compact Simulator	UCS 500 N5	EM TEST	V0936105120	06, 27, 2017
<input checked="" type="checkbox"/>	Motor Variac	MV2616	EM TEST	V0936105123	06, 27, 2017
<input type="checkbox"/>	CDN	CNV 504N	EM TEST	V0936105121	06, 27, 2017
<input type="checkbox"/>	CDN	CNV 508T5	EM TEST	P1549168422	04, 27, 2017
<input checked="" type="checkbox"/>	CDN	CNV 508N1	EM TEST	P1551168979	04, 27, 2017
<input checked="" type="checkbox"/>	EMS Test S/W	iec.control	EM TEST AG	5.0.9.0	-

**Test Conditions**

Temperature: 17,5 °C  
Relative Humidity: 49,3 %  
Atmospheric Pressure: 100,6 kPa

## Test Specifications

### AC Power Lines

- Source Impedance: 12 ohm for common mode and 2 ohm for differential mode
- Surge Amplitude : Common Mode  
 (0,5 / 1,0 / 2,0) kV  
Differential Mode  
 (0,5 / 1,0) kV
- Number of Surges:  5 surges per angle
- Angle:  0°, 90°, 180°, 270° (input a.c. power port)
- Polarity:  Positive & Negative
- Repetition Rate:  1 surge per min     1 surge per 30 sec.
- Required Performance Criteria:  Complied

### Other supply / Signal Lines

- Source Impedance: 42 ohm for common mode
- Surge Amplitude: Common Mode  
 (0,5 / 1,0) kV
- Number of Surges:  5 Surges
- Polarity:  Positive & Negative
- Repetition Rate:  1 surge per min     1 surge per 30 sec.
- Required Performance Criteria:  Complied

**Test Data**

- AC 24 V Mode

Line to Line – Differential Mode

Mode of Application	Observations	
	(+) Surge (kV)	(-) Surge (kV)
L – N	Complied	Complied
L – PE	-	-
N – PE	-	-

Line to Earth – Common Mode

Mode of Application	Observations	
	(+) Surge (kV)	(-) Surge (kV)
-	-	-

**Signal Lines**

Line to Earth – Common Mode

Mode of Application	Observations	
	(+) Surge (kV)	(-) Surge (kV)
Alarm	Complied	Complied
RJ-45	Complied	Complied

- DC 12 V Mode

Line to Line – Differential Mode

Mode of Application	Observations	
	(+) Surge (kV)	(-) Surge (kV)
L – N	-	-
L – PE	-	-
N – PE	-	-

Line to Earth – Common Mode

Mode of Application	Observations	
	(+) Surge (kV)	(-) Surge (kV)
L1-PE	Complied	Complied
L2-PE	Complied	Complied

**Signal Lines**

Line to Earth – Common Mode

Mode of Application	Observations	
	(+) Surge (kV)	(-) Surge (kV)
Alarm	Complied	Complied
RJ-45	Complied	Complied

This report shall not be reproduced except in full, without the written approval of KES Co., Ltd.  
The results shown in this test report refer only to the sample(s) tested unless otherwise stated.



- POE Mode

Line to Line – Differential Mode

Mode of Application	Observations	
	(+) Surge (kV)	(-) Surge (kV)
L – N	-	-
L – PE	-	-
N – PE	-	-

Line to Earth – Common Mode

Mode of Application	Observations	
	(+) Surge (kV)	(-) Surge (kV)
L1-PE	-	-
L2-PE	-	-

**Signal Lines**

Line to Earth – Common Mode

Mode of Application	Observations	
	(+) Surge (kV)	(-) Surge (kV)
Alarm	Complied	Complied
RJ-45	Complied	Complied

Note: "Blank" = Not performed

Observations:  
Complied – No degradation of function

**Test Results**

- PASS Required Performance Criteria
- NOT PASS Required Performance Criteria

**Remarks**

PASS Required Performance Criteria.

### 3.5 Conducted Disturbance

**Reference Standard**

EN 61000-4-6:2014

**Test Date**

Dec, 05, 2016

**Test Location**

EMS-CS: Electro wave Shieldroom

**Test Equipment**

Used	Description	Model Number	Manufacturer	Serial Number	Cal. Due
<input checked="" type="checkbox"/>	Continuous Wave Generator	CWS 500N1	EM TEST	V0936105119	08, 08, 2017
<input checked="" type="checkbox"/>	6 dB Attenuator	ATT6	EM TEST	1208-34	08, 08, 2017
<input checked="" type="checkbox"/>	CDN	CDN-M2/M3N	EM TEST	0909-06	08, 08, 2017
<input type="checkbox"/>	CDN	CDN-T2-RJ11	EM TEST	0909-07	08, 08, 2017
<input type="checkbox"/>	CDN	CDN-T4	EM TEST	0909-08	08, 08, 2017
<input type="checkbox"/>	CDN	CDN-T8RJ45	EM TEST	0909-09	08, 08, 2017
<input type="checkbox"/>	CDN	CDN-AF2	EM TEST	0909-10	08, 08, 2017
<input type="checkbox"/>	CDN	CDN-AF4	EM TEST	0909-11	08, 08, 2017
<input checked="" type="checkbox"/>	EM Injection Clamp	EM 101	Liithi	35943	02, 04, 2017
<input checked="" type="checkbox"/>	EMS Test S/W	icd.control	EM TEST AG	5.3.7	-

**Test Conditions**

Temperature: 17,5 °C  
Relative Humidity: 49,3 %  
Atmospheric Pressure: 100,6 kPa



**KES Co., Ltd.**

C-3701, Simin-daero 365-40,  
Dongan-gu, Anyang-si, Gyeonggi-do, 14057, Korea  
Tel: +82-31-425-6200 / Fax: +82-31-424-0450  
www.kes.co.kr

Test report No.:  
KES-E1-16T0613  
Page (38) of (99)

---

**Test Specifications**

- Frequency range:  150 kHz to 100 MHz  150 kHz to 80 MHz
- Voltage Level:  1 Vrms  3 Vrms  
 10 Vrms
- Modulation:  AM, 80 %, 1 kHz sine wave  
 PM, 1 Hz (0,5 s ON : 0,5 s OFF)
- Frequency step:  1 % step
- Dwell Time:  1 s  3 s
- Required Performance Criteria:  Complied

---

This report shall not be reproduced except in full, without the written approval of KES Co., Ltd.  
The results shown in this test report refer only to the sample(s) tested unless otherwise stated.

**Test Data**

- AC 24 V Mode

Input a.c. power ports

Coupling Location (Line Stressed)	Coupling Method	Observations
L - N	CDN ( <input checked="" type="checkbox"/> M2, <input type="checkbox"/> M3)	Complied

Input d.c. power ports

Coupling Location (Line Stressed)	Coupling Method	Observations
-	CDN ( <input type="checkbox"/> M2, <input type="checkbox"/> M3)	-

Signal ports and telecommunication ports

Coupling Location (Line Stressed)	Coupling Method	Observations
Alarm (2Pin)	EM Injection Clamp	Complied
RJ-45	EM Injection Clamp	Complied

- DC 12 V Mode

Input a.c. power ports

Coupling Location (Line Stressed)	Coupling Method	Observations
-	CDN ( <input type="checkbox"/> M2, <input type="checkbox"/> M3)	-

Input d.c. power ports

Coupling Location (Line Stressed)	Coupling Method	Observations
L1 - L2	CDN ( <input checked="" type="checkbox"/> M2, <input type="checkbox"/> M3)	Complied

Signal ports and telecommunication ports

Coupling Location (Line Stressed)	Coupling Method	Observations
Alarm (2Pin)	EM Injection Clamp	Complied
RJ-45	EM Injection Clamp	Complied





- PoE Mode

Input a.c. power ports

Coupling Location (Line Stressed)	Coupling Method	Observations
-	CDN ( <input type="checkbox"/> M2, <input type="checkbox"/> M3)	-

Input d.c. power ports

Coupling Location (Line Stressed)	Coupling Method	Observations
-	CDN ( <input type="checkbox"/> M2, <input type="checkbox"/> M3)	-

Signal ports and telecommunication ports

Coupling Location (Line Stressed)	Coupling Method	Observations
Alarm (2Pin)	EM Injection Clamp	Complied
RJ-45	EM Injection Clamp	Complied

Notes: CDN = Coupling Decoupling Network  
"blank" = Not performed

Observations:  
Complied – No degradation of function

**Test Results**

- PASS Required Performance Criteria
- NOT PASS Required Performance Criteria

**Remarks**

PASS Required Performance Criteria.

### 3.6 Voltage Dips and Short Interruptions

**Reference Standard**

EN 61000-4-11:2004

**Test Date**

Dec, 05, 2016

**Test Location**

EMS-Voltage dip: Electro wave Shieldroom

**Test Equipment**

Used	Description	Model Number	Manufacturer	Serial Number	Cal. Due
<input checked="" type="checkbox"/>	Ultra Compact Simulator	UCS 500 N5	EM TEST	V0936105120	06, 27, 2017
<input checked="" type="checkbox"/>	Motor Variac	MV2616	EM TEST	V0936105123	06, 27, 2017
<input checked="" type="checkbox"/>	EMS Test S/W	iec.control	EM TEST AG	5.0.9.0	-

**Test Conditions**Temperature: 17,5 °C  
Relative Humidity: 49,3 %  
Atmospheric Pressure: 100,6 kPa



---

### Test Specifications & Observations/Remarks

- AC 24 V Mode

(Test Voltage : 50 Hz)

<u>Test Level</u>	<u>Duration [in period/ms (50 Hz)]</u>	<u>Results</u>
<input checked="" type="checkbox"/> 20 % dip	<input checked="" type="checkbox"/> 250 /5000	<u>Complied</u>
<input checked="" type="checkbox"/> 30 % dip	<input checked="" type="checkbox"/> 25 /500	<u>Complied</u>
<input checked="" type="checkbox"/> 60 % dip	<input checked="" type="checkbox"/> 10 /200	<u>Complied</u>
<input checked="" type="checkbox"/> 100 % dip	<input checked="" type="checkbox"/> 250 /5000	<u>Complied</u>

- Voltage variations

<input checked="" type="checkbox"/> Unom + 10 %	<input checked="" type="checkbox"/> 253 V (ac)	<u>Complied</u>
<input checked="" type="checkbox"/> Unom - 15 %	<input checked="" type="checkbox"/> 195.5 V (ac)	<u>Complied</u>

Observations:

Complied – No degradation of function

#### Test Results

- PASS Required Performance Criteria
- NOT PASS Required Performance Criteria
- NOT APPLICABLE

#### Remarks

The test has been tested using the AC/AC Adapter

## APPENDIX A – TEST DATA

### Conducted Emissions at Mains Power Ports

- AC 24 V Mode

[HOT]

#### Common Information

Test Description:	Conducted Emission
Model No.:	XNO-6080RP
Mode	AC 24 V H
Operator Name:	KES

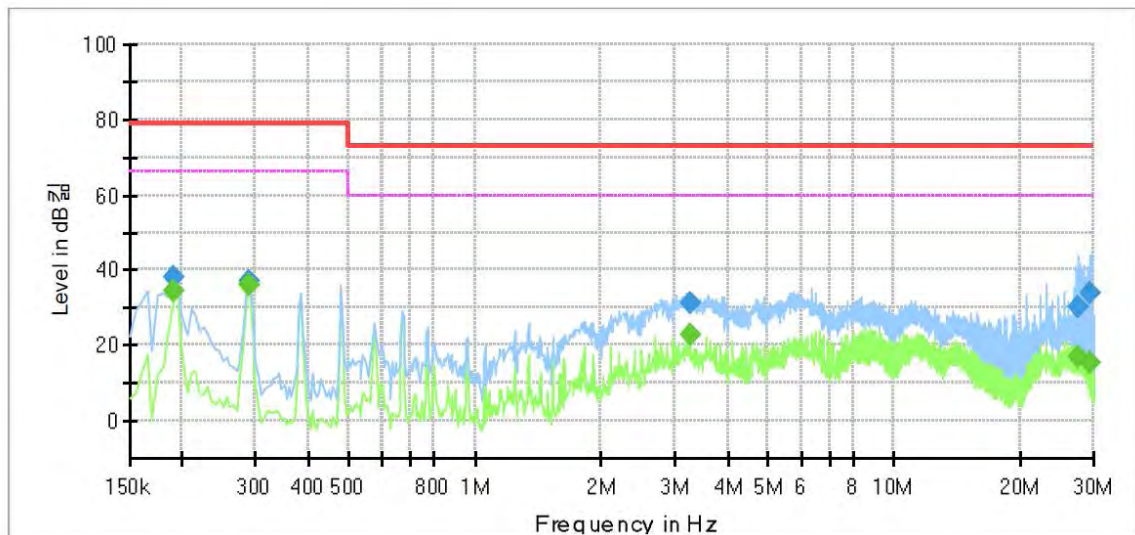

#### Final Result

Frequency (MHz)	QuasiPeak (dBµV)	CAverage (dBµV)	Limit (dBµV)	Margin (dB)	Meas. Time (ms)	Bandwidth (kHz)	Line	Corr. (dB)
0.190000	---	34.49	66.00	31.51	1000.0	9.000	L1	9.7
0.190000	38.27	---	79.00	40.73	1000.0	9.000	L1	9.7
0.290000	---	35.98	66.00	30.02	1000.0	9.000	L1	9.7
0.290000	36.99	---	79.00	42.01	1000.0	9.000	L1	9.7
3.265000	---	22.91	60.00	37.09	1000.0	9.000	L1	10.2
3.265000	31.09	---	73.00	41.91	1000.0	9.000	L1	10.2
27.485000	---	16.77	60.00	43.23	1000.0	9.000	L1	10.3
27.485000	30.34	---	73.00	42.66	1000.0	9.000	L1	10.3
29.305000	---	15.61	60.00	44.39	1000.0	9.000	L1	10.4
29.305000	33.93	---	73.00	39.07	1000.0	9.000	L1	10.4

#### ◆ Calculation

QuasiPeak [dBuV] / CAverage [dBuV] = Reading Value [dBuV] + Corr. [dB]

QuasiPeak / CAverage : The Final Value

Reading Value : Not shown in the table.

Corr. : Correction values (LISN FACTOR+ Cable Loss)

This report shall not be reproduced except in full, without the written approval of KES Co., Ltd.  
The results shown in this test report refer only to the sample(s) tested unless otherwise stated.

[NEUTRAL]

## Common Information

Test Description: Conducted Emission  
 Model No.: XNO-6080RP  
 Mode: AC 24 V N  
 Operator Name: KES

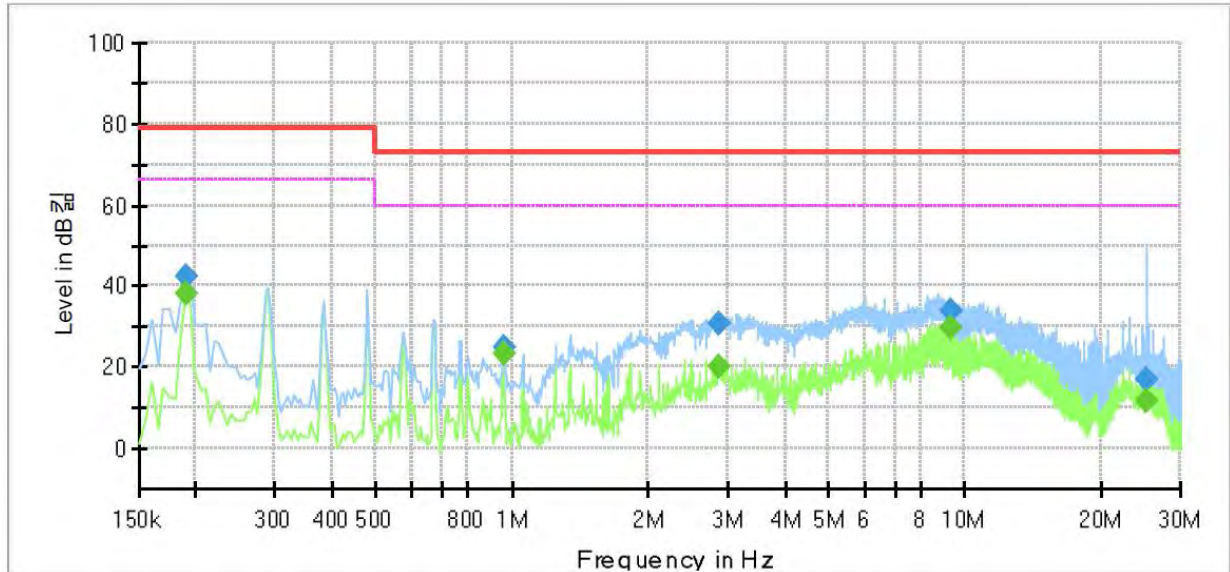

## Final Result

Frequency (MHz)	QuasiPeak (dBμV)	CAverage (dBμV)	Limit (dBμV)	Margin (dB)	Meas. Time (ms)	Bandwidth (kHz)	Line	Corr. (dB)
0.190000	---	38.37	66.00	27.63	1000.0	9.000	N	9.7
0.190000	42.57	---	79.00	36.43	1000.0	9.000	N	9.7
0.960000	---	23.51	60.00	36.49	1000.0	9.000	N	10.0
0.960000	25.02	---	73.00	47.98	1000.0	9.000	N	10.0
2.870000	---	20.39	60.00	39.61	1000.0	9.000	N	10.2
2.870000	30.57	---	73.00	42.43	1000.0	9.000	N	10.2
9.310000	---	29.79	60.00	30.21	1000.0	9.000	N	9.8
9.310000	34.01	---	73.00	38.99	1000.0	9.000	N	9.8
25.270000	---	11.83	60.00	48.17	1000.0	9.000	N	10.3
25.270000	16.72	---	73.00	56.28	1000.0	9.000	N	10.3

◆ Calculation

QuasiPeak[dBuV] / CAverage [dBuV] = Reading Value[dBuV] + Corr. [dB]

QuasiPeak / CAverage : The Final Value

Reading Value : Not shown in the table.

Corr. : Correction values (LISN FACTOR+ Cable Loss)

## Conducted Emissions at Telecommunication Ports

- AC 24 V Mode

[10 Mbps]

### Common Information

Test Description:	Telecommunication Emission
Model No.:	XNO-6080RP
Mode	AC 24 V 10 Mbps
Operator Name:	KES

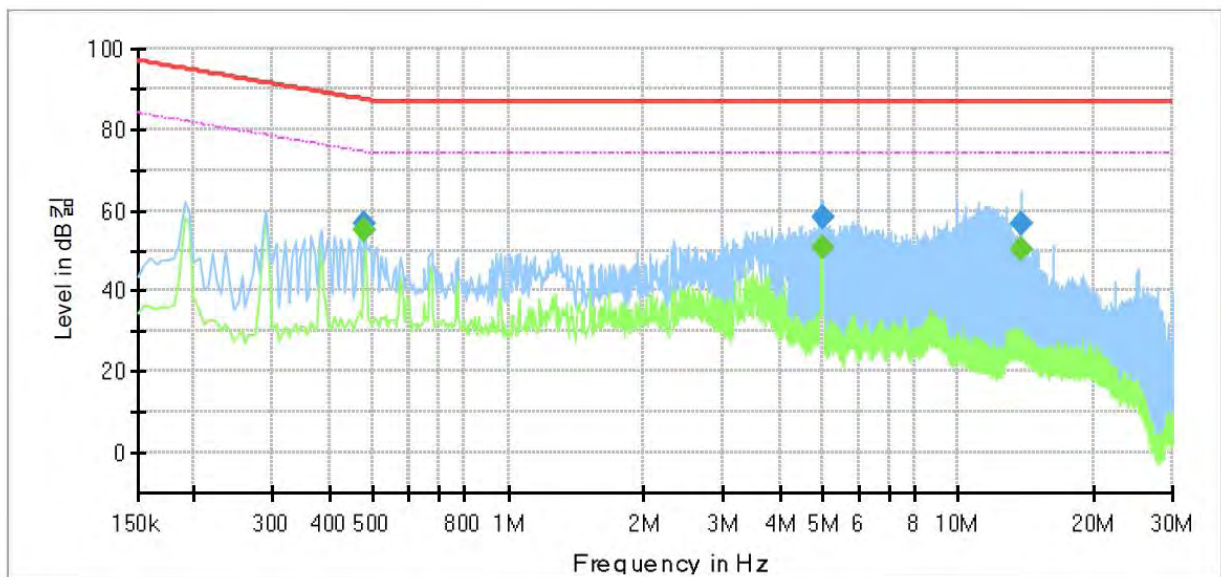

### Final Result

Frequency (MHz)	QuasiPeak (dBμV)	CAverage (dBμV)	Limit (dBμV)	Margin (dB)	Meas. Time (ms)	Bandwidth (kHz)	Line	Corr. (dB)
0.480000	---	55.20	74.34	19.14	1000.0	9.000	Single Line	10.1
0.480000	56.59	---	87.34	30.75	1000.0	9.000	Single Line	10.1
5.000000	---	50.58	74.00	23.42	1000.0	9.000	Single Line	10.1
5.000000	57.99	---	87.00	29.01	1000.0	9.000	Single Line	10.1
13.750000	---	50.51	74.00	23.49	1000.0	9.000	Single Line	10.1
13.750000	56.43	---	87.00	30.57	1000.0	9.000	Single Line	10.1

◆ Calculation

QuasiPeak [dBuV] / CAverage [dBuV] = Reading Value [dBuV] + Corr. [dB]

QuasiPeak / CAverage : The Final Value

Reading Value : Not shown in the table.

Corr. : Correction values (ISN FACTOR+ Cable Loss)

**[100 Mbps]**

**Common Information**

Test Description:	Telecommunication Emission
Model No.:	XNO-6080RP
Mode	AC 24 V 100 Mbps
Operator Name:	KES

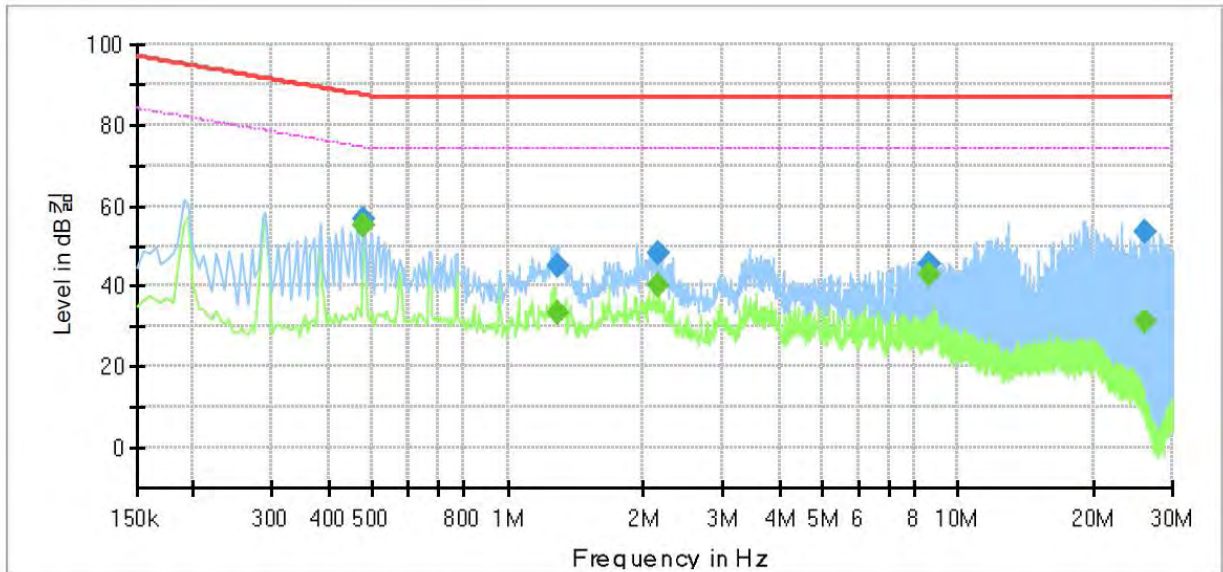

**Final Result**

Frequency (MHz)	QuasiPeak (dBμV)	CAverage (dBμV)	Limit (dBμV)	Margin (dB)	Meas. Time (ms)	Bandwidth (kHz)	Line	Corr. (dB)
0.480000	---	55.01	74.34	19.33	1000.0	9.000	Single Line	9.6
0.480000	56.64	---	87.34	30.70	1000.0	9.000	Single Line	9.6
1.285000	---	33.35	74.00	40.65	1000.0	9.000	Single Line	9.7
1.285000	44.77	---	87.00	42.23	1000.0	9.000	Single Line	9.7
2.165000	---	40.01	74.00	33.99	1000.0	9.000	Single Line	9.7
2.165000	48.29	---	87.00	38.71	1000.0	9.000	Single Line	9.7
8.640000	---	43.12	74.00	30.88	1000.0	9.000	Single Line	9.5
8.640000	45.61	---	87.00	41.39	1000.0	9.000	Single Line	9.5
26.015000	---	31.19	74.00	42.81	1000.0	9.000	Single Line	9.5
26.015000	53.52	---	87.00	33.48	1000.0	9.000	Single Line	9.5

◆ Calculation

QuasiPeak[dBuV] / CAverage [dBuV] = Reading Value[dBuV] + Corr. [dB]

QuasiPeak / CAverage : The Final Value

Reading Value : Not shown in the table.

Corr. : Correction values (ISN FACTOR+ Cable Loss)

- DC 12 V Mode

**[10 Mbps]**

### Common Information

Test Description:	Telecommunication Emission
Model No.:	XNO-6080RP
Mode	DC 12 V 10 Mbps
Operator Name:	KES

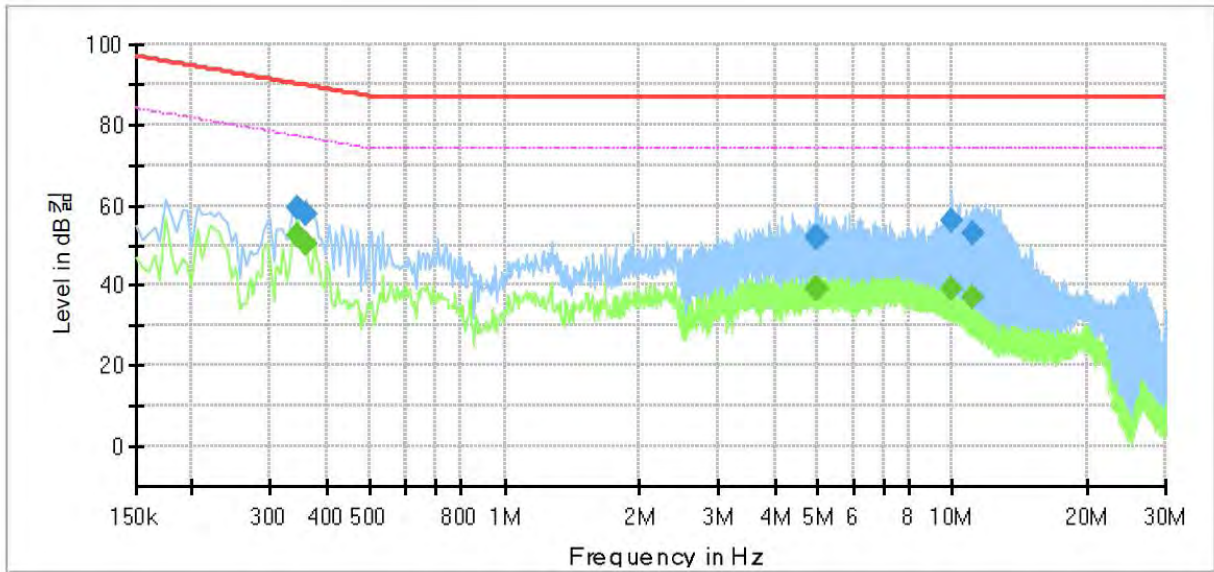

### Final Result

Frequency (MHz)	QuasiPeak (dBμV)	CAverage (dBμV)	Limit (dBμV)	Margin (dB)	Meas. Time (ms)	Bandwidth (kHz)	Line	Corr. (dB)
0.345000	---	52.52	77.08	24.56	1000.0	9.000	Single Line	10.1
0.345000	59.06	---	90.08	31.02	1000.0	9.000	Single Line	10.1
0.360000	---	50.10	76.73	26.63	1000.0	9.000	Single Line	10.1
0.360000	57.62	---	89.73	32.11	1000.0	9.000	Single Line	10.1
4.970000	---	39.17	74.00	34.83	1000.0	9.000	Single Line	10.1
4.970000	51.98	---	87.00	35.02	1000.0	9.000	Single Line	10.1
5.020000	---	39.06	74.00	34.94	1000.0	9.000	Single Line	10.1
5.020000	51.90	---	87.00	35.10	1000.0	9.000	Single Line	10.1
10.005000	---	39.12	74.00	34.88	1000.0	9.000	Single Line	10.0
10.005000	56.12	---	87.00	30.88	1000.0	9.000	Single Line	10.0
11.100000	---	37.09	74.00	36.91	1000.0	9.000	Single Line	10.0
11.100000	52.87	---	87.00	34.13	1000.0	9.000	Single Line	10.0

◆ Calculation

QuasiPeak[dBuV] / CAverage [dBuV] = Reading Value[dBuV] + Corr. [dB]

QuasiPeak / CAverage : The Final Value

Reading Value : Not shown in the table.

Corr. : Correction values (ISN FACTOR+ Cable Loss)

This report shall not be reproduced except in full, without the written approval of KES Co., Ltd.  
The results shown in this test report refer only to the sample(s) tested unless otherwise stated.



[100 Mbps]

## Common Information

Test Description:	Telecommunication Emission
Model No.:	XNO-6080RP
Mode	DC 12 V 100 Mbps
Operator Name:	KES

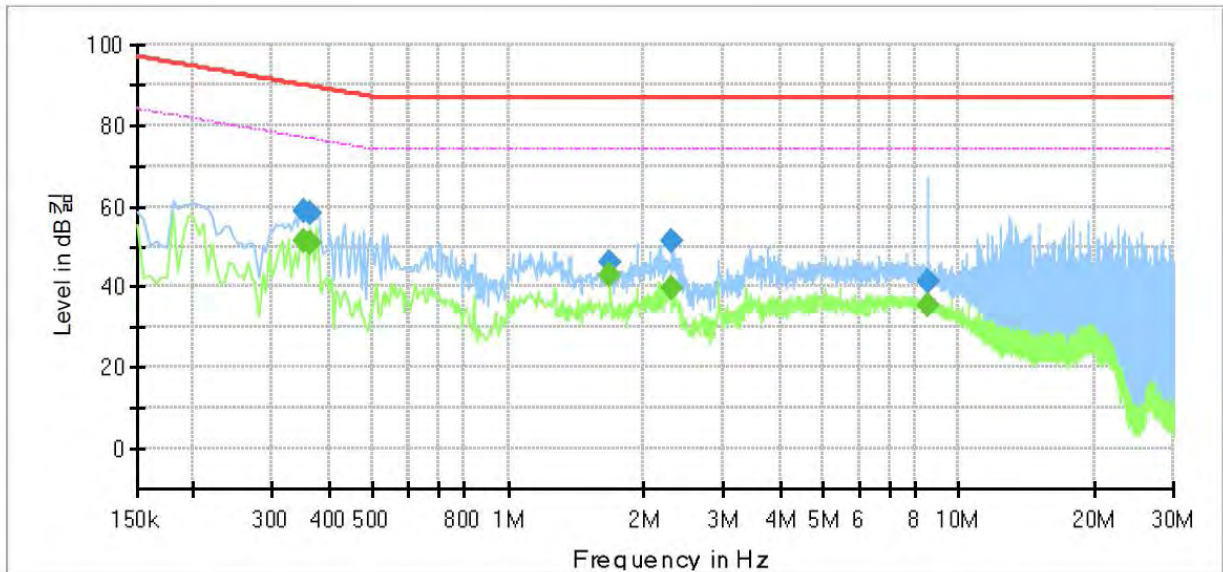

## Final Result

Frequency (MHz)	QuasiPeak (dBμV)	CAverage (dBμV)	Limit (dBμV)	Margin (dB)	Meas. Time (ms)	Bandwidth (kHz)	Line	Corr. (dB)
0.350000	---	51.38	76.96	25.58	1000.0	9.000	Single Line	9.6
0.350000	58.49	---	89.96	31.47	1000.0	9.000	Single Line	9.6
0.365000	---	50.81	76.61	25.80	1000.0	9.000	Single Line	9.6
0.365000	57.98	---	89.61	31.63	1000.0	9.000	Single Line	9.6
1.680000	---	42.98	74.00	31.02	1000.0	9.000	Single Line	9.7
1.680000	46.11	---	87.00	40.89	1000.0	9.000	Single Line	9.7
2.300000	---	39.69	74.00	34.31	1000.0	9.000	Single Line	9.7
2.300000	51.11	---	87.00	35.89	1000.0	9.000	Single Line	9.7
8.530000	---	35.52	74.00	38.48	1000.0	9.000	Single Line	9.5
8.530000	41.33	---	87.00	45.67	1000.0	9.000	Single Line	9.5

### ◆ Calculation

QuasiPeak[dBuV] / CAverage [dBuV] = Reading Value[dBuV] + Corr. [dB]

QuasiPeak / CAverage : The Final Value

Reading Value : Not shown in the table.

Corr. : Correction values (ISN FACTOR+ Cable Loss)

- PoE Mode

**[10 Mbps]**

## Common Information

Test Description:	Telecommunication Emission
Model No.:	XNO-6080RP
Mode	POE 10 Mbps
Operator Name:	KES

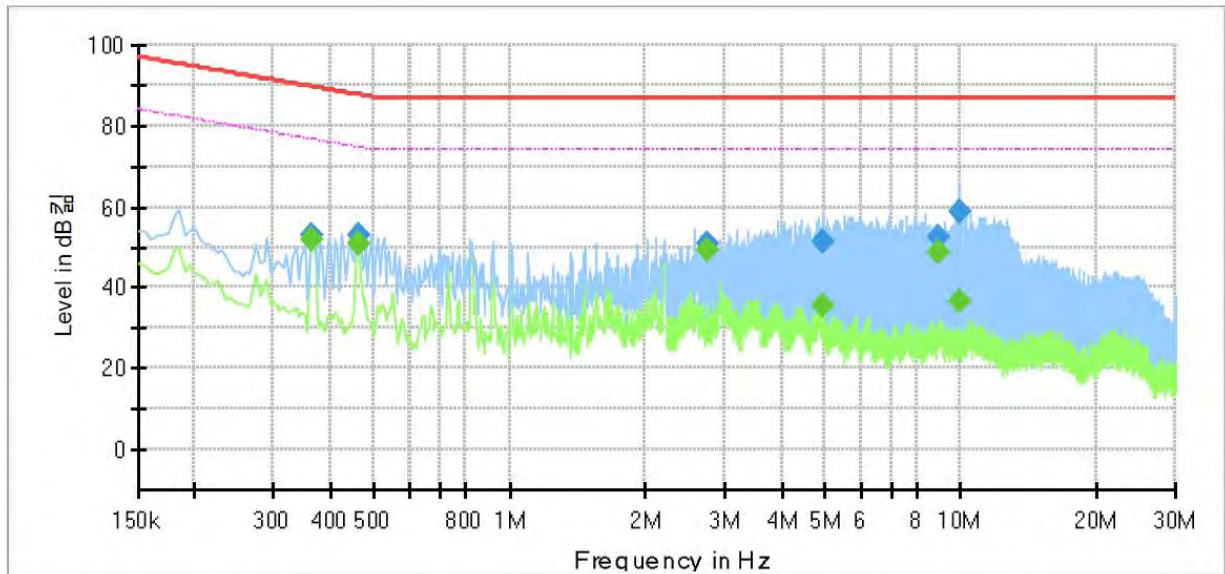

## Final Result

Frequency (MHz)	QuasiPeak (dBμV)	CAverage (dBμV)	Limit (dBμV)	Margin (dB)	Meas. Time (ms)	Bandwidth (kHz)	Line	Corr. (dB)
0.365000	---	51.89	76.61	24.72	1000.0	9.000	Single Line	10.1
0.365000	52.76	---	89.61	36.85	1000.0	9.000	Single Line	10.1
0.460000	---	50.91	74.69	23.78	1000.0	9.000	Single Line	10.1
0.460000	53.03	---	87.69	34.66	1000.0	9.000	Single Line	10.1
2.745000	---	49.20	74.00	24.80	1000.0	9.000	Single Line	10.2
2.745000	50.76	---	87.00	36.24	1000.0	9.000	Single Line	10.2
4.935000	---	35.22	74.00	38.78	1000.0	9.000	Single Line	10.1
4.935000	51.12	---	87.00	35.88	1000.0	9.000	Single Line	10.1
8.920000	---	48.57	74.00	25.43	1000.0	9.000	Single Line	10.0
8.920000	52.61	---	87.00	34.39	1000.0	9.000	Single Line	10.0
10.000000	---	36.44	74.00	37.56	1000.0	9.000	Single Line	10.0
10.000000	58.93	---	87.00	28.07	1000.0	9.000	Single Line	10.0

### ◆ Calculation

QuasiPeak [dBμV] / CAverage [dBμV] = Reading Value [dBμV] + Corr. [dB]

QuasiPeak / CAverage : The Final Value

Reading Value : Not shown in the table.

Corr. : Correction values (ISN FACTOR+ Cable Loss)

This report shall not be reproduced except in full, without the written approval of KES Co., Ltd.  
 The results shown in this test report refer only to the sample(s) tested unless otherwise stated.

**[100 Mbps]**

**Common Information**

Test Description:	Telecommunication Emission
Model No.:	XNO-6080RP
Mode	POE 100 Mbps
Operator Name:	KES

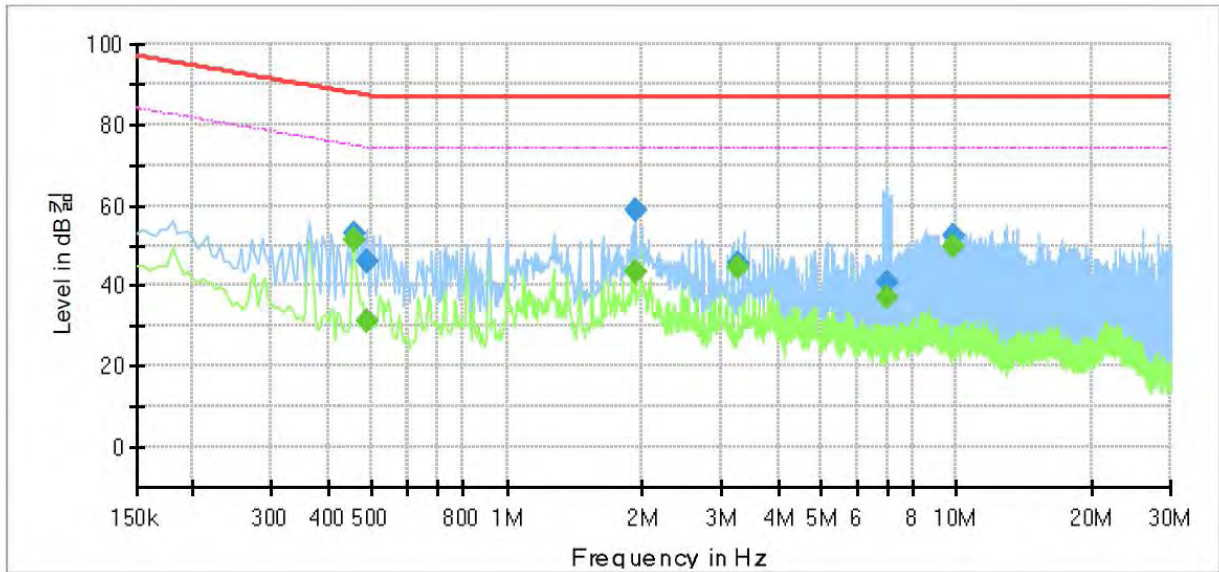

**Final Result**

Frequency (MHz)	QuasiPeak (dB $\mu$ V)	CAverage (dB $\mu$ V)	Limit (dB $\mu$ V)	Margin (dB)	Meas. Time (ms)	Bandwidth (kHz)	Line	Corr. (dB)
0.455000	---	51.52	74.78	23.26	1000.0	9.000	Single Line	9.6
0.455000	52.97	---	87.78	34.81	1000.0	9.000	Single Line	9.6
0.490000	---	31.03	74.17	43.14	1000.0	9.000	Single Line	9.6
0.490000	45.85	---	87.17	41.32	1000.0	9.000	Single Line	9.6
1.935000	---	43.61	74.00	30.39	1000.0	9.000	Single Line	9.7
1.935000	58.86	---	87.00	28.14	1000.0	9.000	Single Line	9.7
3.270000	---	44.43	74.00	29.57	1000.0	9.000	Single Line	9.7
3.270000	45.47	---	87.00	41.53	1000.0	9.000	Single Line	9.7
7.010000	---	37.03	74.00	36.97	1000.0	9.000	Single Line	9.5
7.010000	40.64	---	87.00	46.36	1000.0	9.000	Single Line	9.5
9.880000	---	49.89	74.00	24.11	1000.0	9.000	Single Line	9.5
9.880000	52.59	---	87.00	34.41	1000.0	9.000	Single Line	9.5

◆ Calculation

QuasiPeak[dBuV] / CAverage [dBuV] = Reading Value[dBuV] + Corr. [dB]

QuasiPeak / CAverage : The Final Value

Reading Value : Not shown in the table.

Corr. : Correction values (ISN FACTOR+ Cable Loss)



## Radiated Electric Field Emissions(Below 1 GHz)

- AC 24 V Mode

Frequency [MHz]	Amplitude [dB $\mu$ V]	ANT Polar. (H/V)	ANT. Height [m]	Correction Factor		Corrected Amplitude [dB $\mu$ V/m]	Applicable Limit [dB $\mu$ V/m]	Margin [dB]
				ANT. [dB/m]	Cable [dB]			
64.11	8.14	V	1.23	11.45	2.30	21.89	40.00	18.11
221.17	20.64	H	3.78	11.77	4.37	36.78	40.00	3.22
270.53	22.78	V	1.30	12.81	4.90	40.49	47.00	6.51
344.01	19.16	V	1.18	14.40	5.58	39.14	47.00	7.86
344.53	18.23	H	3.78	14.41	5.59	38.23	47.00	8.77
491.79	10.13	H	3.13	16.99	6.97	34.09	47.00	12.91

\* H : Horizontal, V : Vertical

### ◆ Calculation

Corrected Amplitude [dB $\mu$ V] = Amplitude[dBuV] + Correction Factor [dB]

Corrected Amplitude : The Final Value, Amplitude : Reading Value,

Correction Factor : ANT FACTOR + Cable loss

- DC 12 V Mode

Frequency [MHz]	Amplitude [dB $\mu$ V]	ANT Polar. (H/V)	ANT. Height [m]	Correction Factor		Corrected Amplitude [dB $\mu$ V/m]	Applicable Limit [dB $\mu$ V/m]	Margin [dB]
				ANT. [dB/m]	Cable [dB]			
50.12	8.89	V	1.24	13.93	2.10	24.92	40.00	15.08
221.19	20.73	H	3.78	11.77	4.37	36.87	40.00	3.13
270.53	22.77	V	1.30	12.81	4.90	40.48	47.00	6.52
295.76	23.10	H	3.72	13.30	5.11	41.51	47.00	5.49
320.51	21.58	H	3.94	13.86	5.35	40.79	47.00	6.21
491.88	11.04	V	2.18	16.99	6.97	35.00	47.00	12.00

\* H : Horizontal, V : Vertical

◆ Calculation

Corrected Amplitude [dB $\mu$ V] = Amplitude[dB $\mu$ V] + Correction Factor [dB]

Corrected Amplitude : The Final Value, Amplitude : Reading Value,  
Correction Factor : ANT FACTOR + Cable loss

- PoE Mode

Frequency [MHz]	Amplitude [dB $\mu$ V]	ANT Polar. (H/V)	ANT. Height [m]	Correction Factor		Corrected Amplitude [dB $\mu$ V/m]	Applicable Limit [dB $\mu$ V/m]	Margin [dB]
				ANT. [dB/m]	Cable [dB]			
50.11	8.83	V	1.27	13.94	2.10	24.87	40.00	15.13
221.12	19.64	H	3.58	11.77	4.37	35.78	40.00	4.22
295.67	23.30	H	3.86	13.30	5.11	41.71	47.00	5.29
320.05	18.61	V	1.28	13.85	5.35	37.81	47.00	9.19
320.51	20.97	H	3.86	13.86	5.35	40.18	47.00	6.82
344.53	18.18	H	3.72	14.41	5.59	38.18	47.00	8.82
491.15	9.33	V	1.30	16.98	6.97	33.28	47.00	13.72

\* H : Horizontal, V : Vertical

◆ Calculation

Corrected Amplitude [dB $\mu$ V] = Amplitude[dB $\mu$ V] + Correction Factor [dB]

Corrected Amplitude : The Final Value, Amplitude : Reading Value,  
Correction Factor : ANT FACTOR + Cable loss

## Radiated Electric Field Emissions(Above 1 GHz)

- AC 24 V Mode

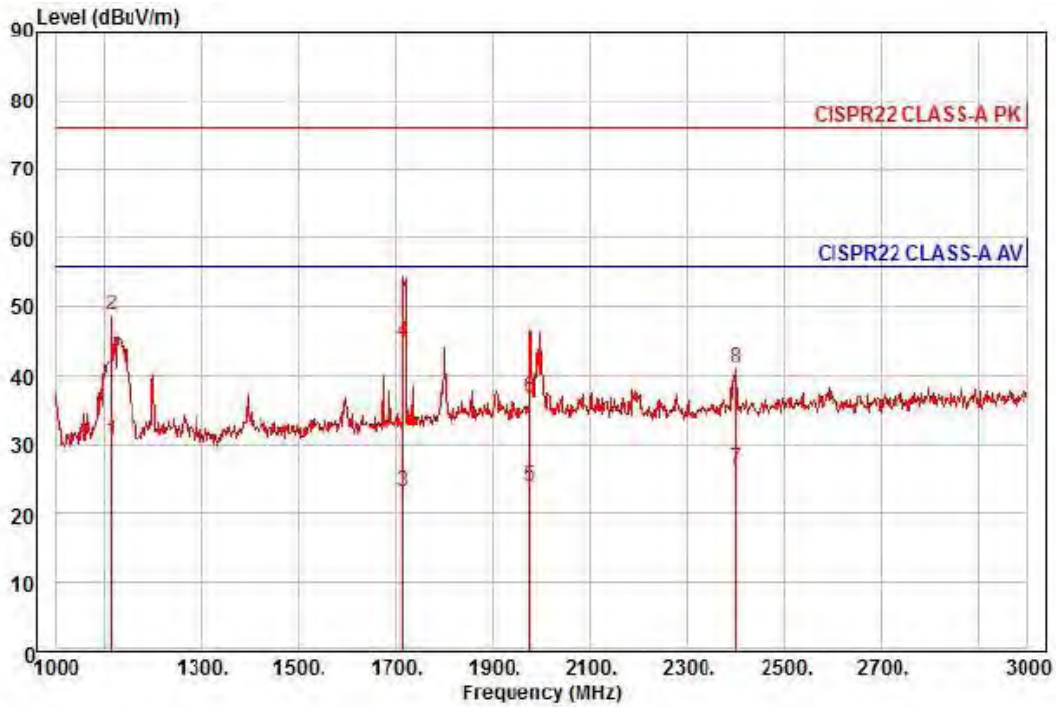

Site : chamber  
Condition: CISPR22 CLASS-A PK 3m HORN781(2015.05.07) horizontal  
: RBW:1000.000kHz VBW:1000.000kHz SWT:Auto  
Project :  
Model : XNO-6080RP  
Mode : AC 24 V  
Memo : (1 ~ 3) GHz

	Read	Ant	Cable	Preamp	TPos	Limit	Over		
Freq	Level	Factor	Loss	Factor		Line	Limit	Pol/Phase	Remark
MHz	dBuV	dB/m	dB	dB	deg	dBuV/m	dB		
1 pp	1114.00	39.25	24.36	6.86	39.82	24	56.00	-25.35	horizontal Average
2 pk	1114.00	57.31	24.36	6.86	39.82	24	76.00	-27.29	horizontal Peak
3	1716.00	27.11	26.75	8.61	39.28	217	56.00	-32.81	horizontal Average
4	1716.00	48.74	26.75	8.61	39.28	217	76.00	-31.18	horizontal Peak
5	1976.00	26.50	27.78	9.27	39.40	306	56.00	-31.85	horizontal Average
6	1976.00	39.02	27.78	9.27	39.40	306	76.00	-39.33	horizontal Peak
7	2400.00	26.66	28.86	10.32	39.42	32	56.00	-29.58	horizontal Average
8	2400.00	41.32	28.86	10.32	39.42	32	76.00	-34.92	horizontal Peak

◆ Calculation

Over Limit [dB] = (Read Level[dBuV] + Ant Factor[dB/m] + Cable Loss [dB] - Preamp Factor [dB]) - Limit Line[dBuV]

Over Limit : Margin Value, Read Level : Reading Value, Ant Factor : Ant Factor,  
Cable Loss : Cable loss, Preamp Factor : Preamp Factor

This report shall not be reproduced except in full, without the written approval of KES Co., Ltd.  
The results shown in this test report refer only to the sample(s) tested unless otherwise stated.

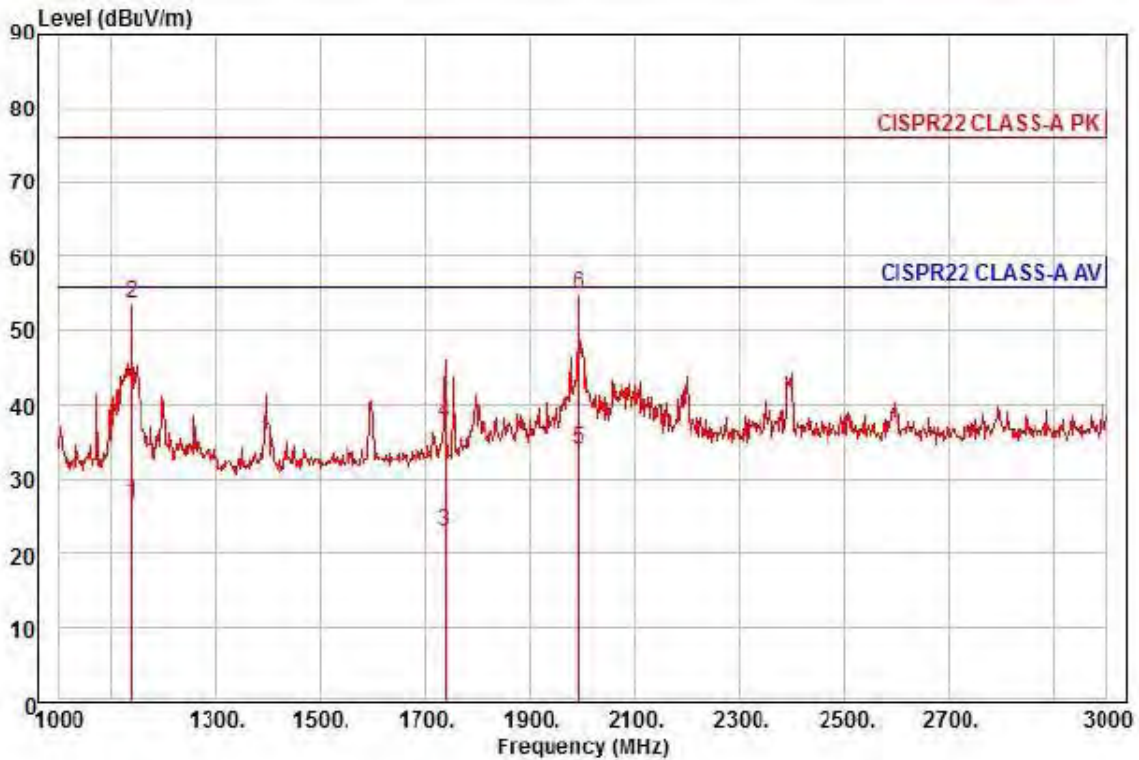

Site : chamber  
 Condition: CISPR22 CLASS-A PK 3m HORN781(2015.05.07) vertical  
 : RBW:1000.000kHz VBW:1000.000kHz SWT:Auto  
 Project :  
 Model : XNO-6080RP  
 Mode : AC 24 V  
 Memo : (1 ~ 3) GHz

	Read	Ant	Cable	Preamp	TPos	Limit	Over			
Freq	Level	Factor	Loss	Factor		Line	Limit	Pol/Phase	Remark	
MHz	dBuV	dB/m	dB	dB	deg	dBuV/m	dB			
1	1138.00	35.15	24.46	6.93	39.76	24	56.00	-29.22	vertical	Average
2	1138.00	61.97	24.46	6.93	39.76	24	76.00	-22.40	vertical	Peak
3	1738.00	26.95	26.84	8.67	39.29	10	56.00	-32.83	vertical	Average
4	1738.00	41.33	26.84	8.67	39.29	10	76.00	-38.45	vertical	Peak
5 av	1994.00	36.26	27.86	9.32	39.41	182	56.00	-21.97	vertical	Average
6 pp	1994.00	57.12	27.86	9.32	39.41	182	76.00	-21.11	vertical	Peak

◆ Calculation

$$\text{Over Limit [dB]} = (\text{Read Level[dBuV]} + \text{Ant Factor[dB/m]} + \text{Cable Loss [dB]} - \text{Preamp Factor [dB]}) - \text{Limit Line[dBuV]}$$

Over Limit : Margin Value, Read Level : Reading Value, Ant Factor : Ant Factor,  
 Cable Loss : Cable loss, Preamp Factor : Preamp Factor

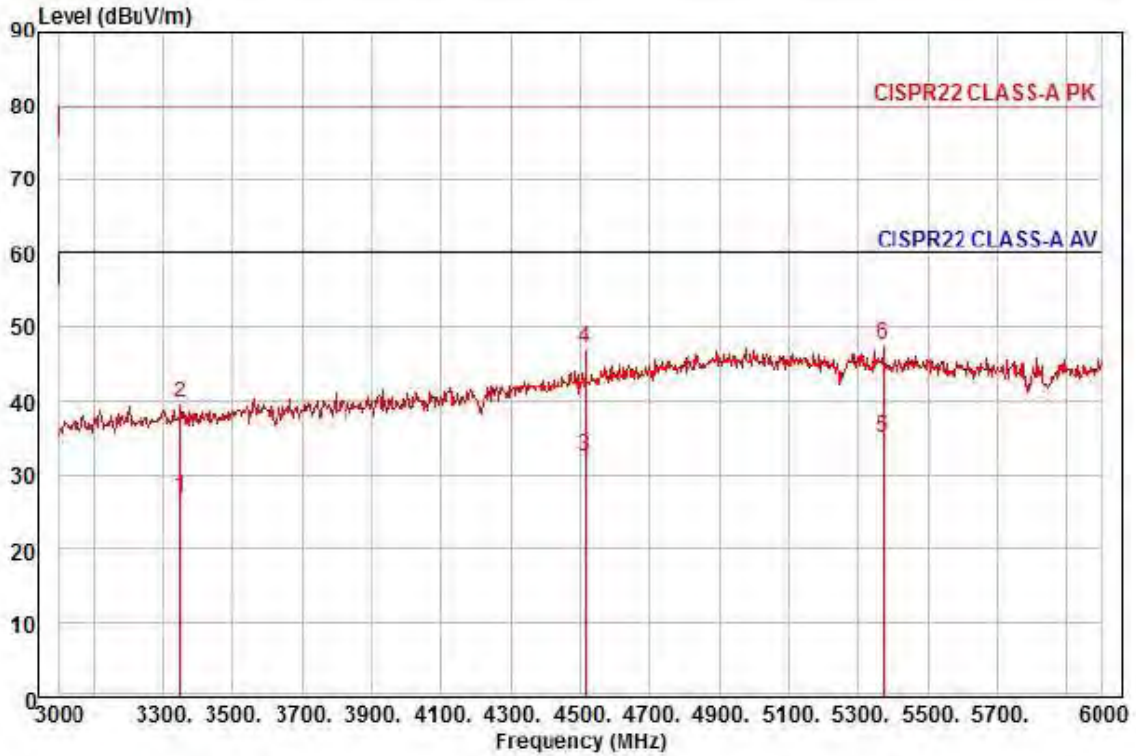

Site : chamber  
 Condition: CISPR22 CLASS-A PK 3m HORN781(2015.05.07) horizontal  
 : RBW:1000.000kHz VBW:1000.000kHz SWT:Auto  
 Project :  
 Model : XNO-6080RP  
 Mode : AC 24 V  
 Memo : ( 3 ~ 6 ) GHz

	Read	Ant	Cable	Preamp	TPos	Limit	Over		
Freq	Level	Factor	Loss	Factor	deg	Line	Limit	Pol/Phase	Remark
MHz	dBuV	dB/m	dB	dB	deg	dBuV/m	dB		
1	3348.00	24.46	30.91	12.35	40.65	256	60.00	-32.93	horizontal Average
2	3348.00	37.11	30.91	12.35	40.65	256	80.00	-40.28	horizontal Peak
3	4515.00	24.00	34.95	14.49	40.76	268	60.00	-27.32	horizontal Average
4	4515.00	38.31	34.95	14.49	40.76	268	80.00	-33.01	horizontal Peak
5 pp	5370.00	22.95	36.97	15.99	40.88	325	60.00	-24.97	horizontal Average
6 pk	5370.00	35.60	36.97	15.99	40.88	325	80.00	-32.32	horizontal Peak

◆ Calculation

Over Limit [dB] = (Read Level[dBuV] + Ant Factor[dB/m] + Cable Loss [dB] - Preamp Factor [dB]) - Limit Line[dBuV]

Over Limit : Margin Value, Read Level : Reading Value, Ant Factor : Ant Factor,  
 Cable Loss : Cable loss, Preamp Factor : Preamp Factor

This report shall not be reproduced except in full, without the written approval of KES Co., Ltd.  
 The results shown in this test report refer only to the sample(s) tested unless otherwise stated.



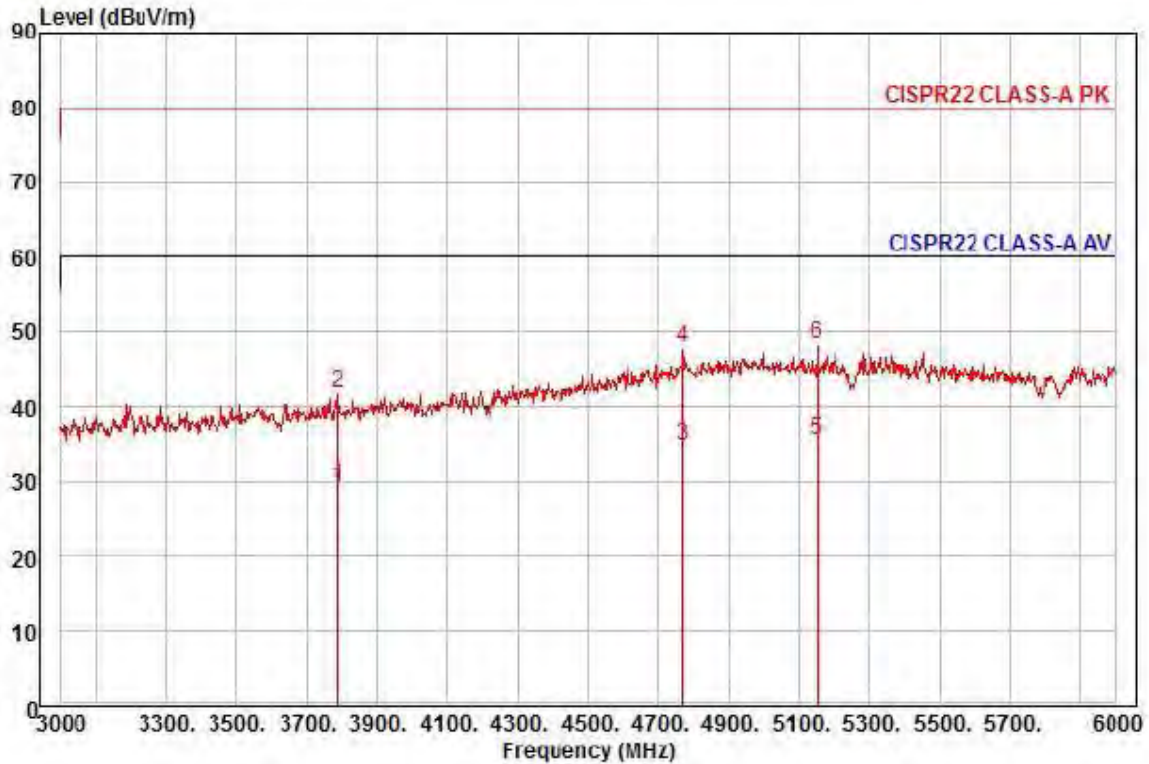

Site : chamber  
 Condition: CISPR22 CLASS-A PK 3m HORN781(2015.05.07) vertical  
 : RBW:1000.000kHz VBW:1000.000kHz SWT:Auto  
 Project :  
 Model : XNO-6080RP  
 Mode : AC 24 V  
 Memo : ( 3 ~ 6 ) GHz

	Read Freq	Read Level	Ant Factor	Cable Loss	Preamp Factor	TPos	Limit Line	Over Limit	Pol/Phase	Remark
	MHz	dBuV	dB/m	dB	dB	deg	dBuV/m	dB		
1	3786.00	25.10	31.65	13.15	40.78	4	60.00	-30.88	vertical	Average
2	3786.00	37.94	31.65	13.15	40.78	4	80.00	-38.04	vertical	Peak
3	4767.00	23.87	36.39	15.03	40.50	254	60.00	-25.21	vertical	Average
4	4767.00	36.94	36.39	15.03	40.50	254	80.00	-32.14	vertical	Peak
5 pp	5151.00	23.06	37.41	15.61	40.52	40	60.00	-24.44	vertical	Average
6 pk	5151.00	35.79	37.41	15.61	40.52	40	80.00	-31.71	vertical	Peak

◆ Calculation

Over Limit [dB] = (Read Level[dBuV] + Ant Factor[dB/m] + Cable Loss [dB] - Preamp Factor [dB]) - Limit Line[dBuV]

Over Limit : Margin Value, Read Level : Reading Value, Ant Factor : Ant Factor,  
 Cable Loss : Cable loss, Preamp Factor : Preamp Factor

- DC 12 V Mode

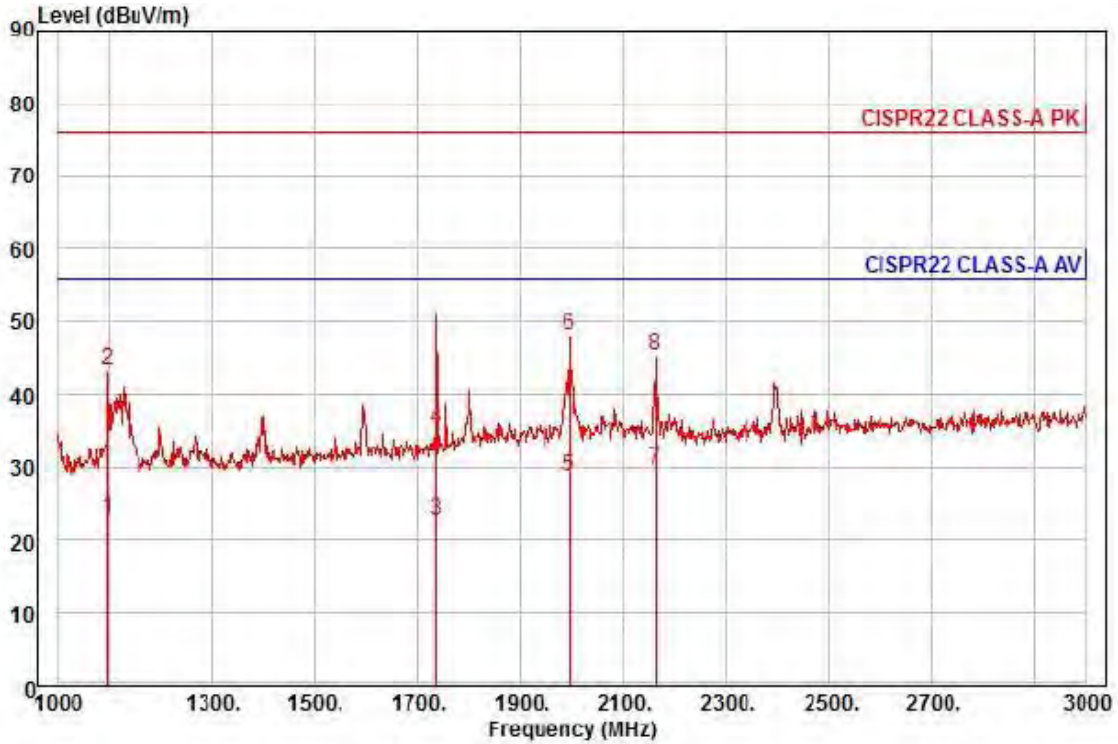

Site : chamber  
 Condition: CISPR22 CLASS-A PK 3m HORN781(2015.05.07) horizontal  
 : RBW:1000.000kHz VBW:1000.000kHz SWT:Auto  
 Project :  
 Model : XNO-6080RP  
 Mode : DC 12 V  
 Memo : (1 ~ 3) GHz

	Read Freq	Read Level	Ant Factor	Cable Loss	Preamp Factor	TPos	Limit Line	Over Limit	Pol/Phase	Remark
	MHz	dBuV	dB/m	dB	dB	deg	dBuV/m	dB		
1	1096.00	31.81	24.29	6.80	39.86	338	56.00	-32.96	horizontal	Average
2	1096.00	52.26	24.29	6.80	39.86	338	76.00	-32.51	horizontal	Peak
3	1736.00	26.67	26.83	8.66	39.29	40	56.00	-33.13	horizontal	Average
4	1736.00	39.19	26.83	8.66	39.29	40	76.00	-40.61	horizontal	Peak
5	1996.00	31.02	27.86	9.33	39.41	270	56.00	-27.20	horizontal	Average
6 pk	1996.00	50.29	27.86	9.33	39.41	270	76.00	-27.93	horizontal	Peak
7 pp	2162.00	31.09	28.28	9.71	39.41	101	56.00	-26.33	horizontal	Average
8	2162.00	46.80	28.28	9.71	39.41	101	76.00	-30.62	horizontal	Peak

◆ Calculation

$$\text{Over Limit [dB]} = (\text{Read Level [dBuV]} + \text{Ant Factor [dB/m]} + \text{Cable Loss [dB]} - \text{Preamp Factor [dB]}) - \text{Limit Line [dBuV]}$$

Over Limit : Margin Value, Read Level : Reading Value, Ant Factor : Ant Factor,  
 Cable Loss : Cable loss, Preamp Factor : Preamp Factor

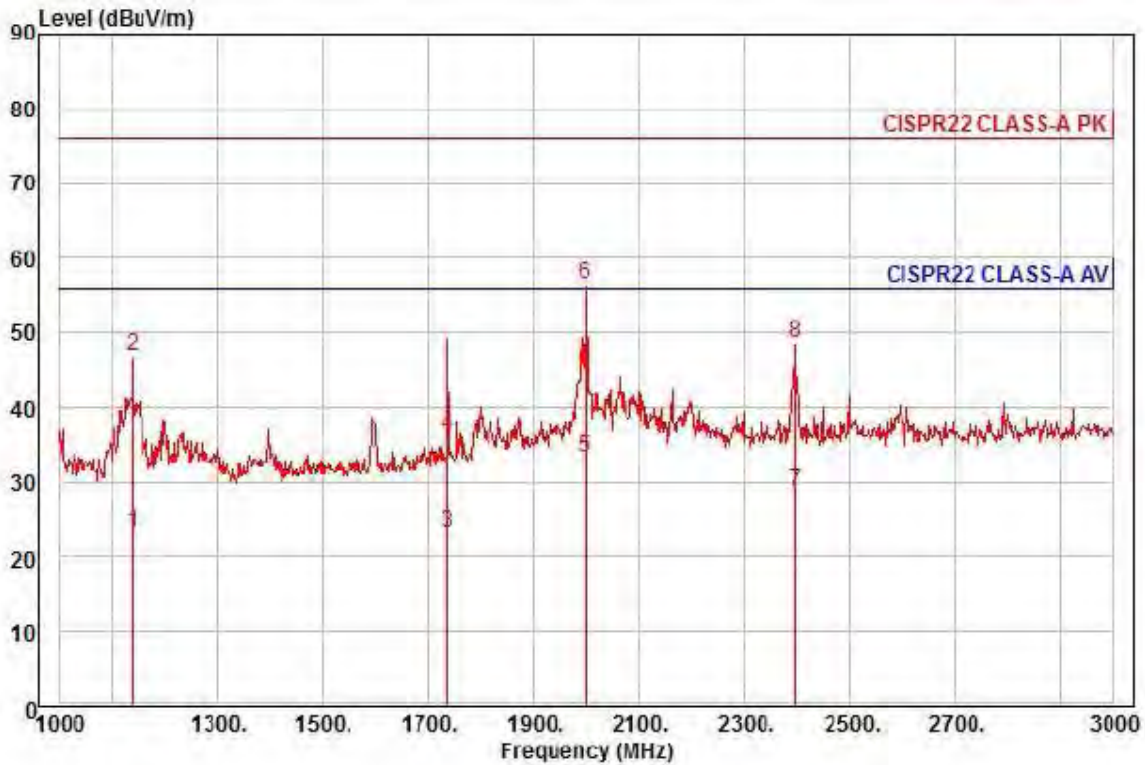

Site : chamber  
 Condition: CISPR22 CLASS-A PK 3m HORN781(2015.05.07) vertical  
 : RBW:1000.000kHz VBW:1000.000kHz SWT:Auto  
 Project :  
 Model : XNO-6080RP  
 Mode : DC 12 V  
 Memo : (1 ~ 3) GHz

	Read Freq	Read Level	Ant Factor	Cable Loss	Preamp Factor	TPos	Limit Line	Over Limit	Pol/Phase	Remark
	MHz	dBuV	dB/m	dB	dB	deg	dBuV/m	dB		
1	1138.00	31.68	24.46	6.93	39.76	284	56.00	-32.69	vertical	Average
2	1138.00	55.33	24.46	6.93	39.76	284	76.00	-29.04	vertical	Peak
3	1736.00	27.20	26.83	8.66	39.29	45	56.00	-32.60	vertical	Average
4	1736.00	40.14	26.83	8.66	39.29	45	76.00	-39.66	vertical	Peak
5 av	2000.00	35.65	27.88	9.34	39.41	339	56.00	-22.54	vertical	Average
6 pp	2000.00	58.61	27.88	9.34	39.41	339	76.00	-19.58	vertical	Peak
7	2398.00	29.04	28.86	10.32	39.42	331	56.00	-27.20	vertical	Average
8	2398.00	48.89	28.86	10.32	39.42	331	76.00	-27.35	vertical	Peak

◆ Calculation

Over Limit [dB] = (Read Level[dBuV] + Ant Factor[dB/m] + Cable Loss [dB] - Preamp Factor [dB]) - Limit Line[dBuV]

Over Limit : Margin Value, Read Level : Reading Value, Ant Factor : Ant Factor,  
 Cable Loss : Cable loss, Preamp Factor : Preamp Factor

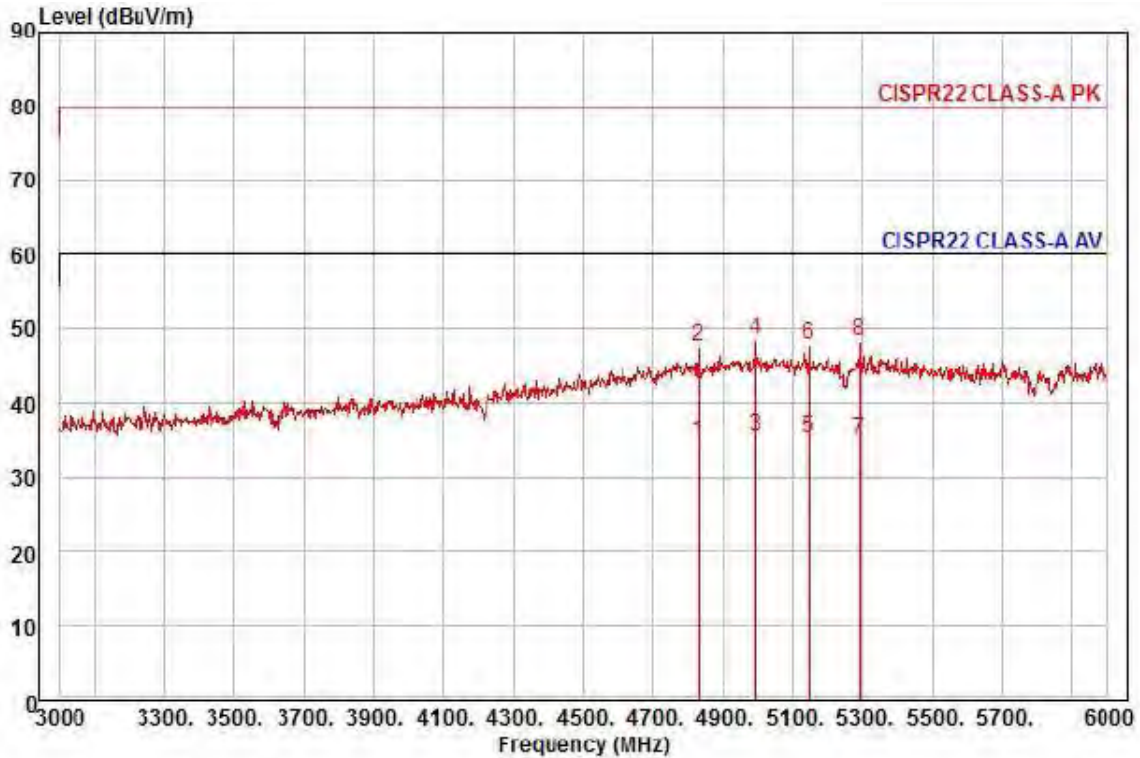

Site : chamber  
 Condition: CISPR22 CLASS-A PK 3m HORN781(2015.05.07) horizontal  
 : RBW:1000.000kHz VBW:1000.000kHz SWT:Auto  
 Project :  
 Model : XNO-6080RP  
 Mode : DC 12 V  
 Memo : (3 ~ 6) GHz

	Read	Ant	Cable	Preamp	TPos	Limit	Over		
Freq	Level	Factor	Loss	Factor	deg	Line	Limit	Pol/Phase	Remark
MHz	dBuV	dB/m	dB	dB	deg	dBuV/m	dB		
1	4833.00	23.32	36.77	15.13	40.44	284	60.00	-25.22	horizontal Average
2	4833.00	36.14	36.77	15.13	40.44	284	80.00	-32.40	horizontal Peak
3 pp	4992.00	22.89	37.67	15.31	40.28	123	60.00	-24.41	horizontal Average
4 pk	4992.00	35.78	37.67	15.31	40.28	123	80.00	-31.52	horizontal Peak
5	5145.00	22.80	37.43	15.60	40.51	71	60.00	-24.68	horizontal Average
6	5145.00	35.24	37.43	15.60	40.51	71	80.00	-32.24	horizontal Peak
7	5292.00	22.75	37.13	15.86	40.75	264	60.00	-25.01	horizontal Average
8	5292.00	35.98	37.13	15.86	40.75	264	80.00	-31.78	horizontal Peak

◆ Calculation

$$\text{Over Limit [dB]} = (\text{Read Level[dBuV]} + \text{Ant Factor[dB/m]} + \text{Cable Loss [dB]} - \text{Preamp Factor [dB]}) - \text{Limit Line[dBuV]}$$

Over Limit : Margin Value, Read Level : Reading Value, Ant Factor : Ant Factor,  
 Cable Loss : Cable loss, Preamp Factor : Preamp Factor

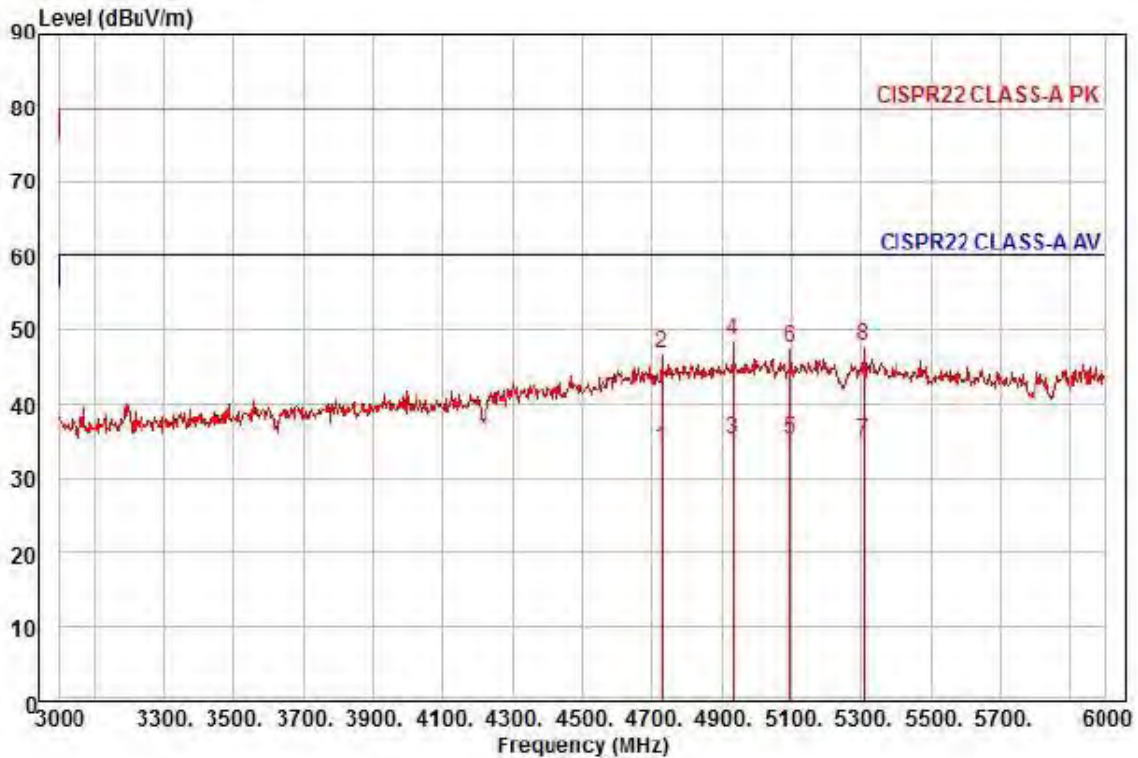

Site : chamber  
 Condition: CISPR22 CLASS-A PK 3m HORN781(2015.05.07) vertical  
 : RBW:1000.000kHz VBW:1000.000kHz SWT:Auto  
 Project :  
 Model : XNO-6080RP  
 Mode : DC 12 V  
 Memo : (3 ~ 6) GHz

	Read	Ant	Cable	Preamp	TPos	Limit	Over			
Freq	Level	Factor	Loss	Factor	deg	Line	Limit	Pol/Phase	Remark	
MHz	dBuV	dB/m	dB	dB	deg	dBuV/m	dB			
1	4728.00	23.46	36.17	14.94	40.54	258	60.00	-25.97	vertical	Average
2	4728.00	36.37	36.17	14.94	40.54	258	80.00	-33.06	vertical	Peak
3	4932.00	23.01	37.33	15.24	40.34	116	60.00	-24.76	vertical	Average
4 pk	4932.00	36.28	37.33	15.24	40.34	116	80.00	-31.49	vertical	Peak
5 pp	5097.00	22.68	37.52	15.51	40.43	222	60.00	-24.72	vertical	Average
6	5097.00	35.08	37.52	15.51	40.43	222	80.00	-32.32	vertical	Peak
7	5307.00	22.92	37.10	15.88	40.78	141	60.00	-24.88	vertical	Average
8	5307.00	35.62	37.10	15.88	40.78	141	80.00	-32.18	vertical	Peak

◆ Calculation

$$\text{Over Limit [dB]} = (\text{Read Level [dBuV]} + \text{Ant Factor [dB/m]} + \text{Cable Loss [dB]} - \text{Preamp Factor [dB]}) - \text{Limit Line [dBuV]}$$

Over Limit : Margin Value, Read Level : Reading Value, Ant Factor : Ant Factor,  
 Cable Loss : Cable loss, Preamp Factor : Preamp Factor

- PoE Mode

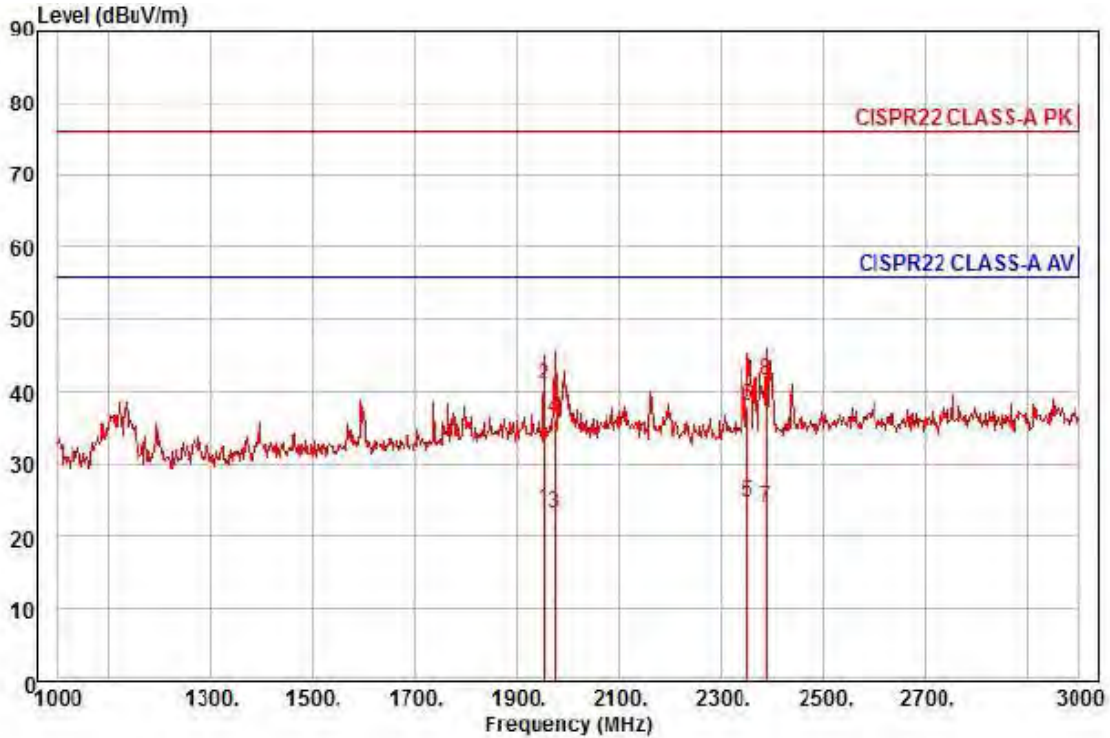

Site : chamber  
 Condition: CISPR22 CLASS-A PK 3m HORN781(2015.05.07) horizontal  
 : RBW:1000.000kHz VBW:1000.000kHz SWT:Auto  
 Project :  
 Model : XNO-6080RP  
 Mode : PoE  
 Memo : (1 ~ 3) GHz

	Read	Ant	Cable	Preamp	TPos	Limit	Over		
	Freq	Level	Factor	Loss	Factor	Line	Limit	Pol/Phase	Remark
	MHz	dBuV	dB/m	dB	dB	deg	dBuV/m	dB	
1	1954.00	26.20	27.70	9.22	39.39	118	56.00	-32.27	horizontal Average
2	1954.00	43.34	27.70	9.22	39.39	118	76.00	-35.13	horizontal Peak
3	1974.00	25.71	27.78	9.27	39.40	116	56.00	-32.64	horizontal Average
4	1974.00	38.70	27.78	9.27	39.40	116	76.00	-39.65	horizontal Peak
5 pp	2352.00	25.19	28.74	10.20	39.42	116	56.00	-31.29	horizontal Average
6	2352.00	38.39	28.74	10.20	39.42	116	76.00	-38.09	horizontal Peak
7	2388.00	24.42	28.83	10.29	39.42	121	56.00	-31.88	horizontal Average
8 pk	2388.00	42.02	28.83	10.29	39.42	121	76.00	-34.28	horizontal Peak

◆ Calculation

$$\text{Over Limit [dB]} = (\text{Read Level[dBuV]} + \text{Ant Factor[dB/m]} + \text{Cable Loss [dB]} - \text{Preamp Factor [dB]}) - \text{Limit Line[dBuV]}$$

Over Limit : Margin Value, Read Level : Reading Value, Ant Factor : Ant Factor,  
 Cable Loss : Cable loss, Preamp Factor : Preamp Factor

This report shall not be reproduced except in full, without the written approval of KES Co., Ltd.  
 The results shown in this test report refer only to the sample(s) tested unless otherwise stated.

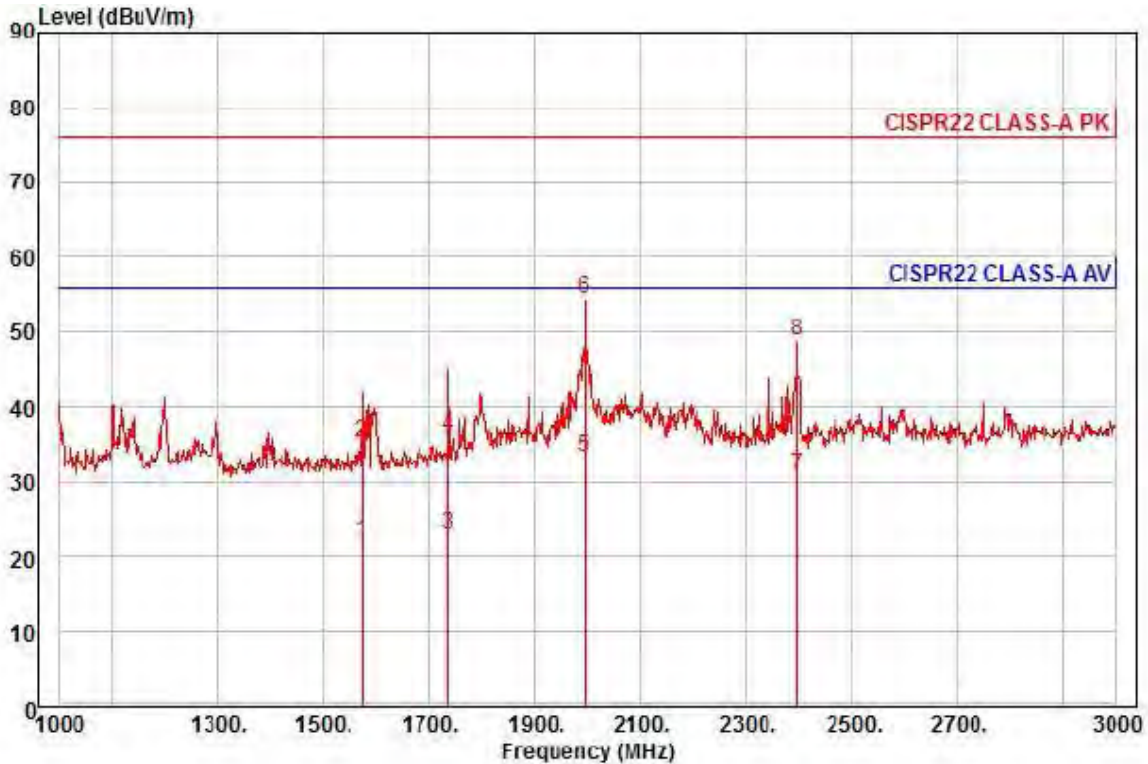

Site : chamber  
 Condition: CISPR22 CLASS-A PK 3m HORN781(2015.05.07) vertical  
 : RBW:1000.000kHz VBW:1000.000kHz SWT:Auto  
 Project :  
 Model : XNO-6080RP  
 Mode : PoE  
 Memo : (1 ~ 3) GHz

	Read Freq	Read Level	Ant Factor	Cable Loss	Preamp Factor	TPos	Limit Line	Over Limit	Pol/Phase	Remark
	MHz	dBuV	dB/m	dB	dB	deg	dBuV/m	dB		
1	1574.00	26.81	26.19	8.23	39.21	275	56.00	-33.98	vertical	Average
2	1574.00	40.06	26.19	8.23	39.21	275	76.00	-40.73	vertical	Peak
3	1736.00	26.79	26.83	8.66	39.29	17	56.00	-33.01	vertical	Average
4	1736.00	39.73	26.83	8.66	39.29	17	76.00	-40.07	vertical	Peak
5 av	1996.00	35.52	27.86	9.33	39.41	348	56.00	-22.70	vertical	Average
6 pp	1996.00	56.68	27.86	9.33	39.41	348	76.00	-21.54	vertical	Peak
7	2398.00	31.04	28.86	10.32	39.42	149	56.00	-25.20	vertical	Average
8	2398.00	48.94	28.86	10.32	39.42	149	76.00	-27.30	vertical	Peak

◆ Calculation

$$\text{Over Limit [dB]} = (\text{Read Level [dBuV]} + \text{Ant Factor [dB/m]} + \text{Cable Loss [dB]} - \text{Preamp Factor [dB]}) - \text{Limit Line [dBuV]}$$

Over Limit : Margin Value, Read Level : Reading Value, Ant Factor : Ant Factor,  
 Cable Loss : Cable loss, Preamp Factor : Preamp Factor

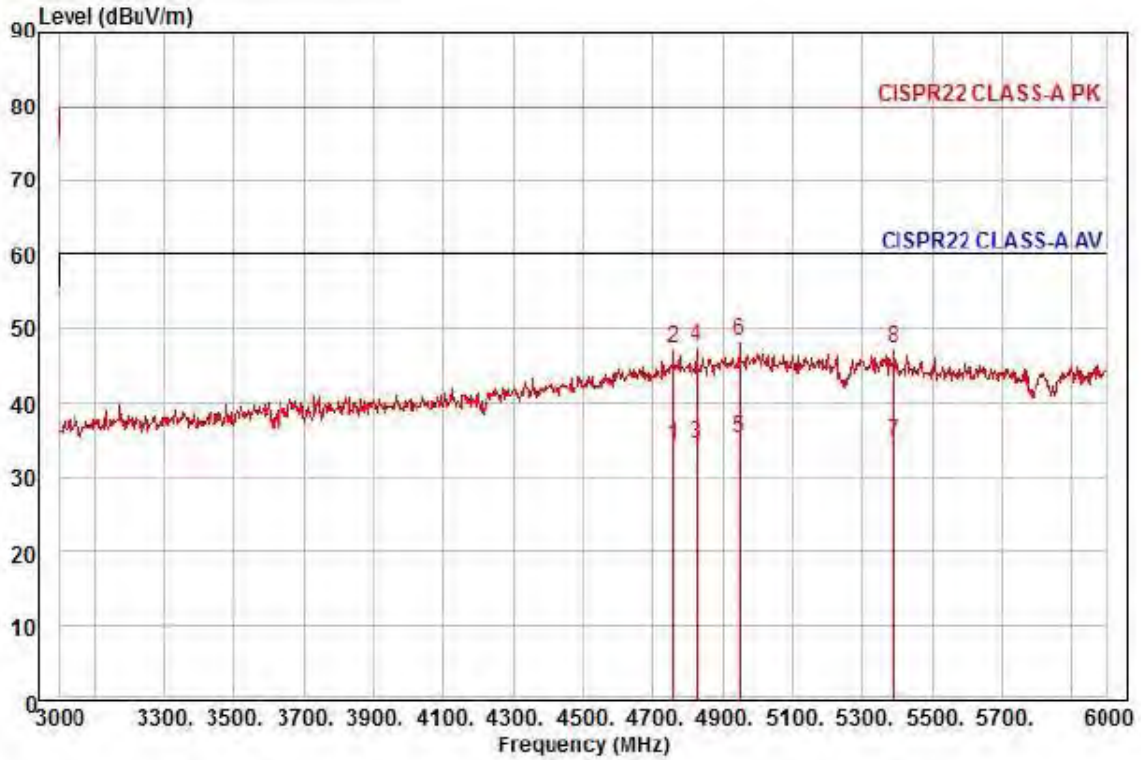

Site : chamber  
 Condition: CISPR22 CLASS-A PK 3m HORN781(2015.05.07) horizontal  
 : RBW:1000.000kHz VBW:1000.000kHz SWT:Auto  
 Project :  
 Model : XNO-6080RP  
 Mode : PoE  
 Memo : ( 3 ~ 6 ) GHz

	Read	Ant	Cable	Preamp	TPos	Limit	Over		
Freq	Level	Factor	Loss	Factor	deg	Line	Limit	Pol/Phase	Remark
MHz	dBuV	dB/m	dB	dB	deg	dBuV/m	dB		
1	4758.00	23.58	36.34	15.01	40.51	23	60.00	-25.58	horizontal Average
2	4758.00	36.47	36.34	15.01	40.51	23	80.00	-32.69	horizontal Peak
3	4827.00	23.24	36.73	15.13	40.44	299	60.00	-25.34	horizontal Average
4	4827.00	36.14	36.73	15.13	40.44	299	80.00	-32.44	horizontal Peak
5 pp	4947.00	22.96	37.42	15.26	40.32	320	60.00	-24.68	horizontal Average
6 pk	4947.00	35.91	37.42	15.26	40.32	320	80.00	-31.73	horizontal Peak
7	5388.00	22.72	36.94	16.02	40.91	239	60.00	-25.23	horizontal Average
8	5388.00	35.30	36.94	16.02	40.91	239	80.00	-32.65	horizontal Peak

◆ Calculation

$$\text{Over Limit [dB]} = (\text{Read Level[dBuV]} + \text{Ant Factor[dB/m]} + \text{Cable Loss [dB]} - \text{Preamp Factor [dB]}) - \text{Limit Line[dBuV]}$$

Over Limit : Margin Value, Read Level : Reading Value, Ant Factor : Ant Factor,  
 Cable Loss : Cable loss, Preamp Factor : Preamp Factor



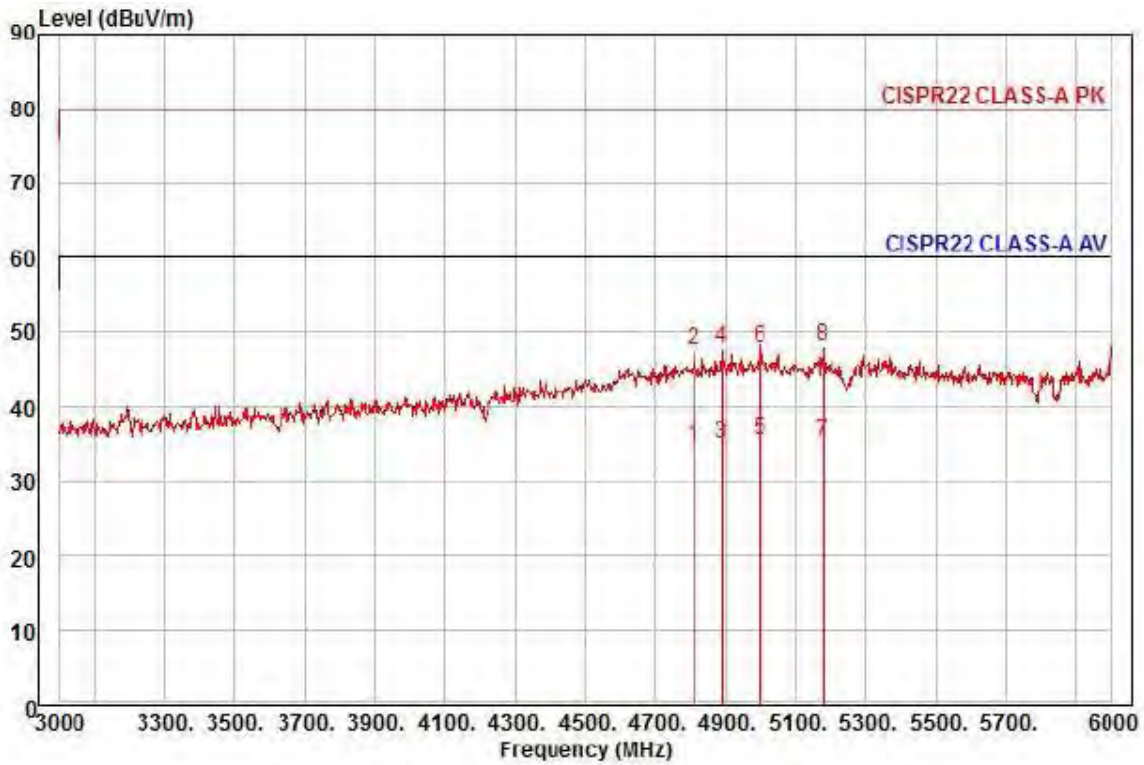

Site : chamber  
 Condition: CISPR22 CLASS-A PK 3m HORN781(2015.05.07) vertical  
 : RBW:1000.000kHz VBW:1000.000kHz SWT:Auto  
 Project :  
 Model : XNO-6080RP  
 Mode : PoE  
 Memo : (3 ~ 6) GHz

	Read Freq	Ant Level	Ant Factor	Cable Loss	Preamp Factor	TPos	Limit Line	Over Limit	Pol/Phase	Remark
	MHz	dBuV	dB/m	dB	dB	deg	dBuV/m	dB		
1	4809.00	23.54	36.63	15.11	40.46	295	60.00	-25.18	vertical	Average
2	4809.00	36.41	36.63	15.11	40.46	295	80.00	-32.31	vertical	Peak
3	4890.00	23.22	37.09	15.20	40.38	12	60.00	-24.87	vertical	Average
4	4890.00	35.92	37.09	15.20	40.38	12	80.00	-32.17	vertical	Peak
5 pp	4998.00	22.92	37.71	15.31	40.27	258	60.00	-24.33	vertical	Average
6	4998.00	35.09	37.71	15.31	40.27	258	80.00	-32.16	vertical	Peak
7	5178.00	22.80	37.36	15.67	40.57	278	60.00	-24.74	vertical	Average
8 pk	5178.00	35.58	37.36	15.67	40.57	278	80.00	-31.96	vertical	Peak

◆ Calculation

$$\text{Over Limit [dB]} = (\text{Read Level[dBuV]} + \text{Ant Factor[dB/m]} + \text{Cable Loss [dB]} - \text{Preamp Factor [dB]}) - \text{Limit Line[dBuV]}$$

Over Limit : Margin Value, Read Level : Reading Value, Ant Factor : Ant Factor,  
 Cable Loss : Cable loss, Preamp Factor : Preamp Factor

This report shall not be reproduced except in full, without the written approval of KES Co., Ltd.  
 The results shown in this test report refer only to the sample(s) tested unless otherwise stated.



## Harmonic Current Emissions and Voltage Fluctuations and Flicker

### *Average harmonic current results*

Hn	I <sub>eff</sub> [A]	% of Limit	Limit [A]	Result
N/A				

Harmonic currents less than 0.6% of the input current measured under the test conditions, or less than 5 mA, whichever is greater, are disregarded.

This report shall not be reproduced except in full, without the written approval of KES Co., Ltd.  
The results shown in this test report refer only to the sample(s) tested unless otherwise stated.



Test Data - Harmonics (continued)

**Maximum harmonic current results**

Hn	I <sub>eff</sub> [A]	% of Limit	Limit [A]	Result
N/A				

Harmonic currents less than 0.6% of the input current measured under the test conditions, or less than 5 mA, whichever is greater, are disregarded.

This report shall not be reproduced except in full, without the written approval of KES Co., Ltd.  
 The results shown in this test report refer only to the sample(s) tested unless otherwise stated.



Test Data - Voltage Fluctuations

**Maximum Flicker results**

	<b>EUT values</b>	<b>Limit</b>	<b>Result</b>
Pst	N/A		
Plt			
dc [%]			
dmax [%]			
Tmax [s]			

This report shall not be reproduced except in full, without the written approval of KES Co., Ltd.  
The results shown in this test report refer only to the sample(s) tested unless otherwise stated.

## Test Setup Photos and Configuration

### Conducted Voltage Emissions

- AC 24 V Mode



This report shall not be reproduced except in full, without the written approval of KES Co., Ltd.  
The results shown in this test report refer only to the sample(s) tested unless otherwise stated.

## Conducted Telecommunication Emissions

- AC 24 V Mode



This report shall not be reproduced except in full, without the written approval of KES Co., Ltd.  
The results shown in this test report refer only to the sample(s) tested unless otherwise stated.

- DC 12 V Mode



This report shall not be reproduced except in full, without the written approval of KES Co., Ltd.  
The results shown in this test report refer only to the sample(s) tested unless otherwise stated.

- PoE Mode

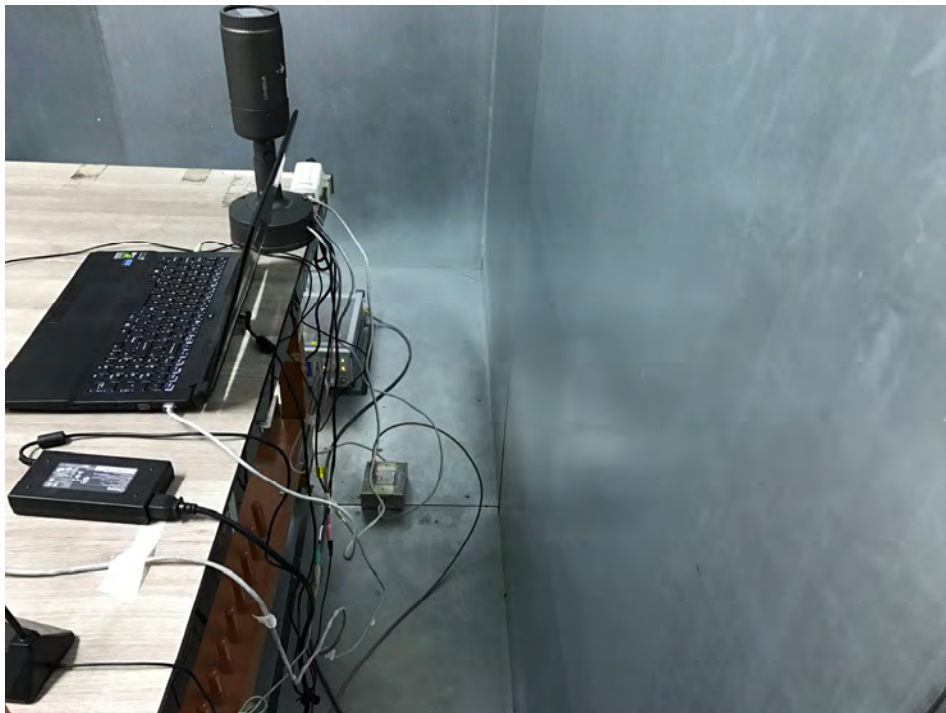

This report shall not be reproduced except in full, without the written approval of KES Co., Ltd.  
The results shown in this test report refer only to the sample(s) tested unless otherwise stated.



## Radiated Electric Field Emissions(Below 1 GHz)

- AC 24 V Mode



This report shall not be reproduced except in full, without the written approval of KES Co., Ltd.  
The results shown in this test report refer only to the sample(s) tested unless otherwise stated.

- DC 12 V Mode



This report shall not be reproduced except in full, without the written approval of KES Co., Ltd.  
The results shown in this test report refer only to the sample(s) tested unless otherwise stated.

- PoE Mode



This report shall not be reproduced except in full, without the written approval of KES Co., Ltd.  
The results shown in this test report refer only to the sample(s) tested unless otherwise stated.

## Radiated Electric Field Emissions(Above 1 GHz)

- AC 24 V Mode

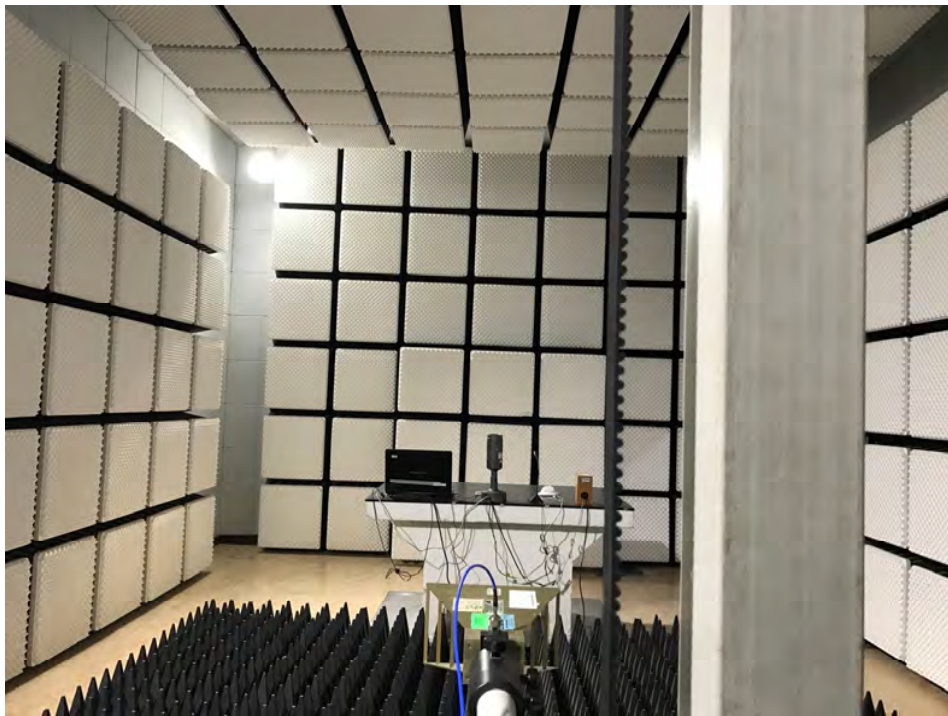
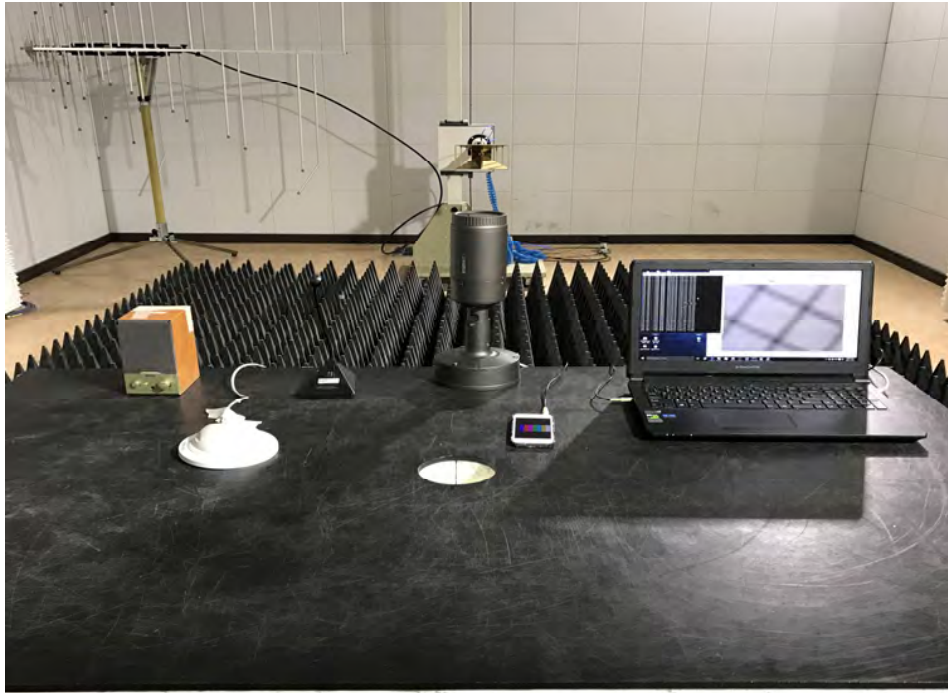

This report shall not be reproduced except in full, without the written approval of KES Co., Ltd.  
The results shown in this test report refer only to the sample(s) tested unless otherwise stated.

- DC 12 V Mode

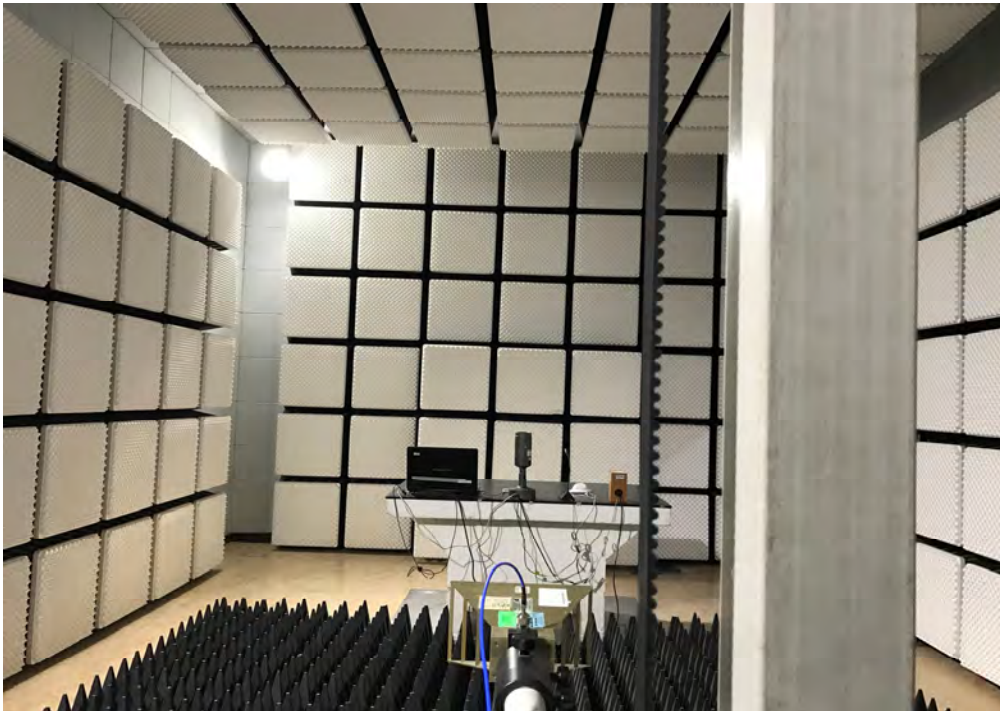

This report shall not be reproduced except in full, without the written approval of KES Co., Ltd.  
The results shown in this test report refer only to the sample(s) tested unless otherwise stated.

- PoE Mode

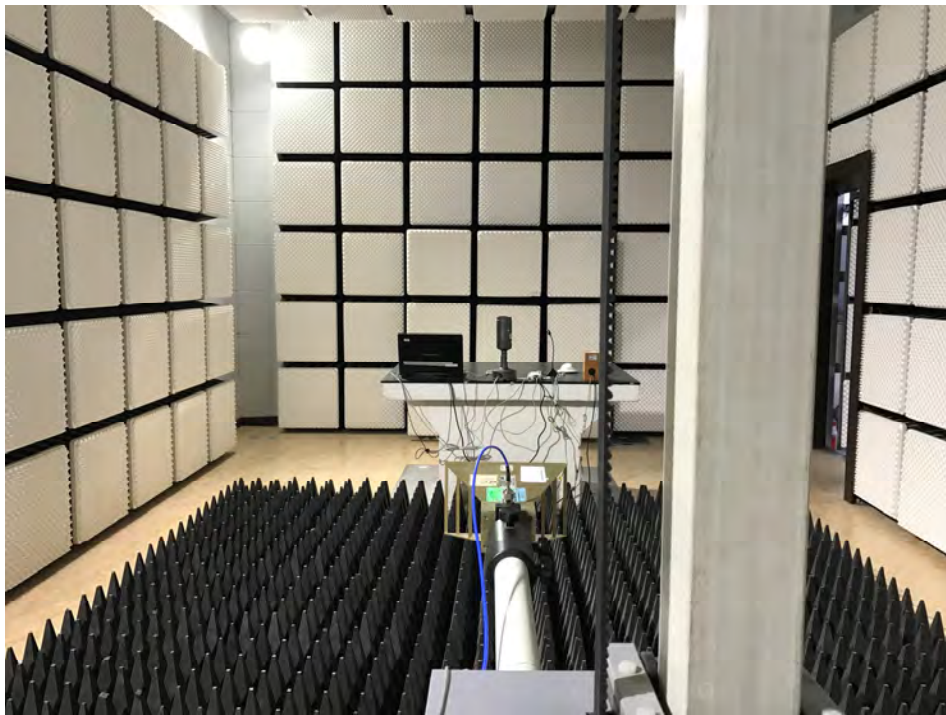
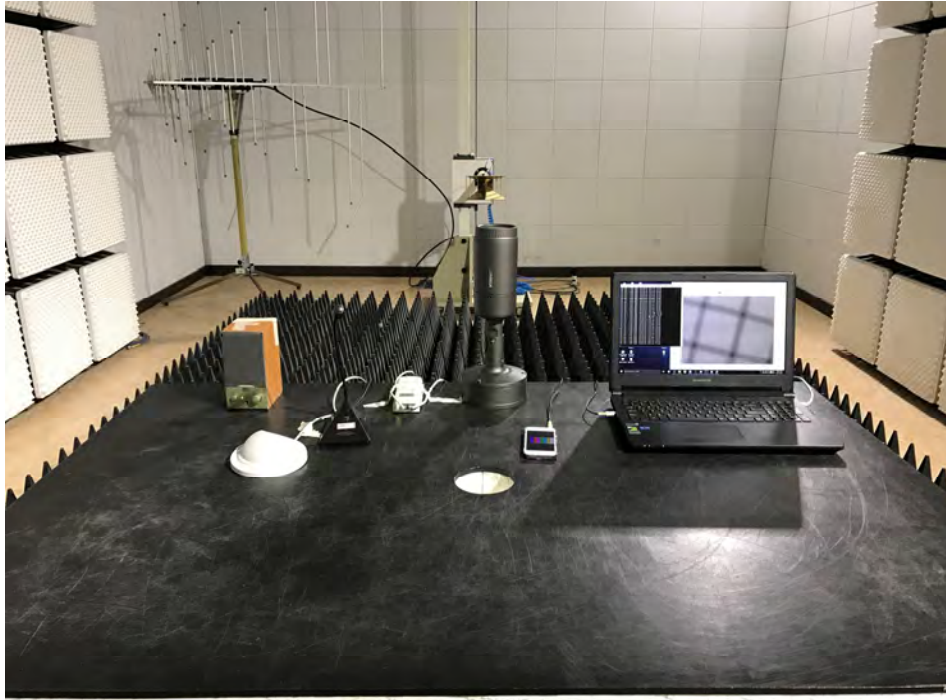

This report shall not be reproduced except in full, without the written approval of KES Co., Ltd.  
The results shown in this test report refer only to the sample(s) tested unless otherwise stated.

---

## Harmonic Current Emissions and Voltage Fluctuations and Flicker

N/A

## Electrostatic Discharge

- AC 24 V Mode



---

This report shall not be reproduced except in full, without the written approval of KES Co., Ltd.  
The results shown in this test report refer only to the sample(s) tested unless otherwise stated.

- DC 12 V Mode



- POE Mode



This report shall not be reproduced except in full, without the written approval of KES Co., Ltd.  
The results shown in this test report refer only to the sample(s) tested unless otherwise stated.



## Radiated Electric Field Immunity

- AC 24 V Mode



- DC 12 V Mode

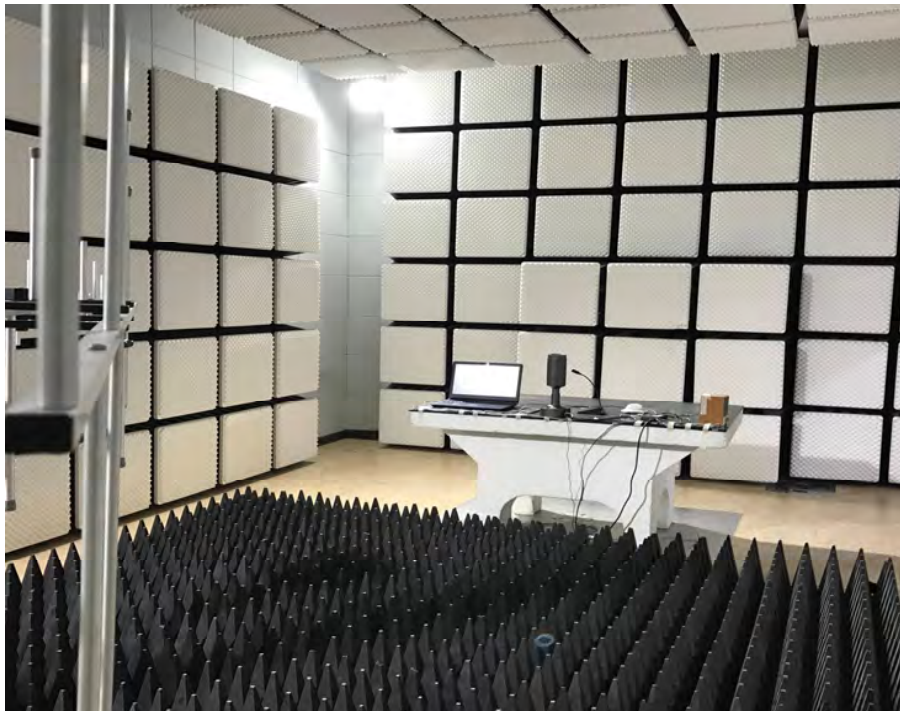

This report shall not be reproduced except in full, without the written approval of KES Co., Ltd.  
The results shown in this test report refer only to the sample(s) tested unless otherwise stated.

- PoE Mode

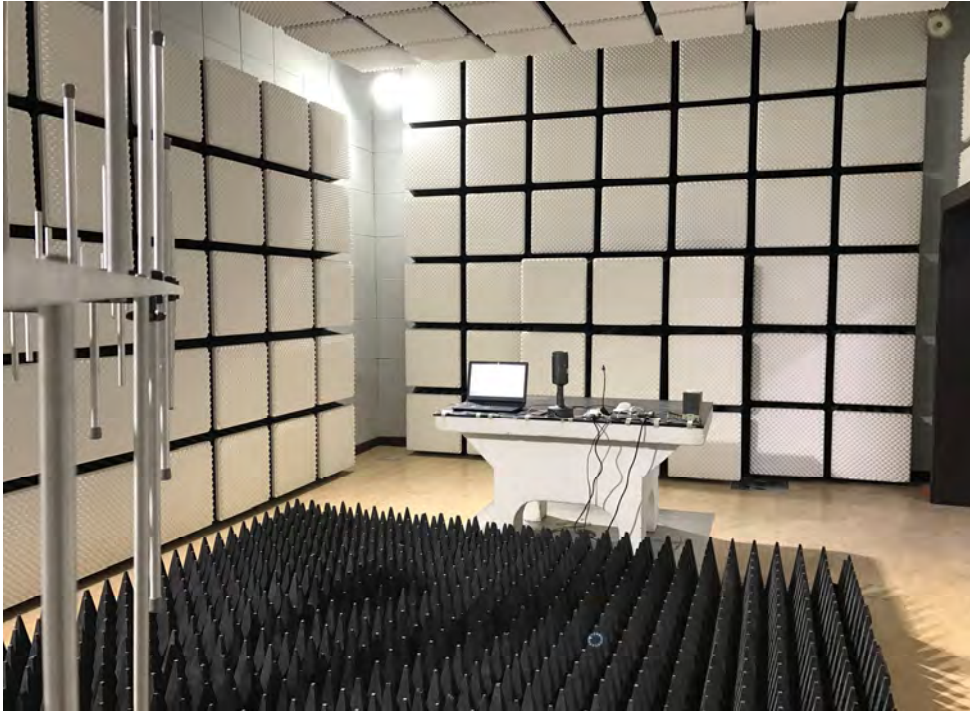

This report shall not be reproduced except in full, without the written approval of KES Co., Ltd.  
The results shown in this test report refer only to the sample(s) tested unless otherwise stated.

## Electrical Fast Transients/Bursts

- AC 24 V Mode



This report shall not be reproduced except in full, without the written approval of KES Co., Ltd.  
The results shown in this test report refer only to the sample(s) tested unless otherwise stated.

- DC 12 V Mode



This report shall not be reproduced except in full, without the written approval of KES Co., Ltd.  
The results shown in this test report refer only to the sample(s) tested unless otherwise stated.

- PoE Mode

N/A



This report shall not be reproduced except in full, without the written approval of KES Co., Ltd.  
The results shown in this test report refer only to the sample(s) tested unless otherwise stated.

## Surge Transients

- AC 24 V Mode



- DC 12 V Mode



This report shall not be reproduced except in full, without the written approval of KES Co., Ltd.  
The results shown in this test report refer only to the sample(s) tested unless otherwise stated.

- PoE Mode



This report shall not be reproduced except in full, without the written approval of KES Co., Ltd.  
The results shown in this test report refer only to the sample(s) tested unless otherwise stated.

## Conducted Disturbance

- AC 24 V Mode

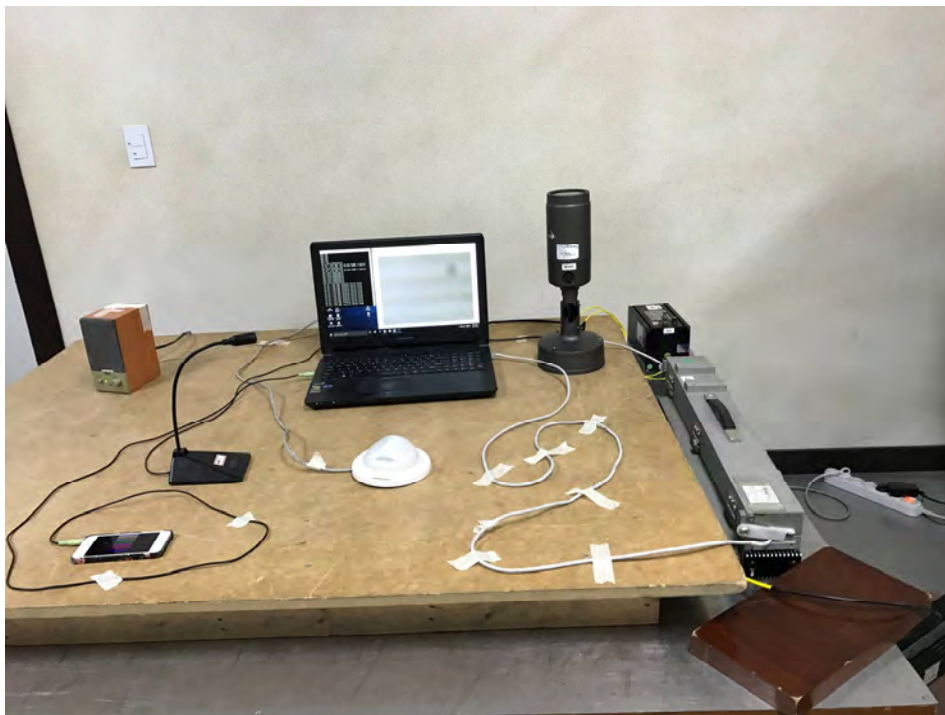

This report shall not be reproduced except in full, without the written approval of KES Co., Ltd.  
The results shown in this test report refer only to the sample(s) tested unless otherwise stated.



- DC 12 V Mode

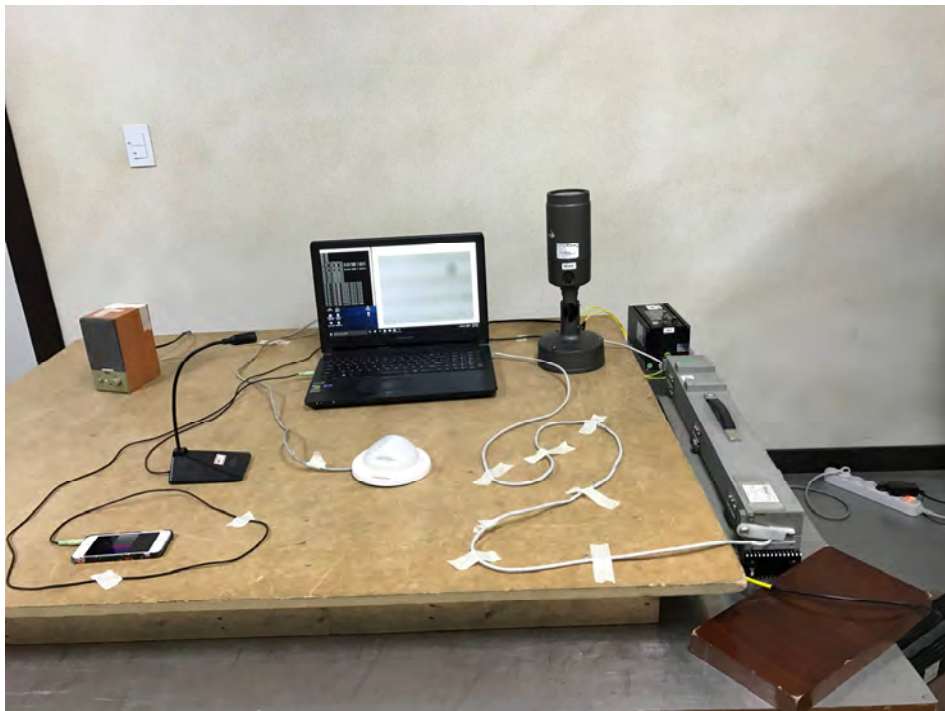

This report shall not be reproduced except in full, without the written approval of KES Co., Ltd.  
The results shown in this test report refer only to the sample(s) tested unless otherwise stated.

- PoE Mode

N/A



This report shall not be reproduced except in full, without the written approval of KES Co., Ltd.  
The results shown in this test report refer only to the sample(s) tested unless otherwise stated.

## Voltage Dips and Short Interruptions

- AC 24 V Mode



This report shall not be reproduced except in full, without the written approval of KES Co., Ltd.  
The results shown in this test report refer only to the sample(s) tested unless otherwise stated.

## EUT External Photographs

(Top)



(Bottom)



This report shall not be reproduced except in full, without the written approval of KES Co., Ltd.  
The results shown in this test report refer only to the sample(s) tested unless otherwise stated.

## EUT Internal Photographs

(Internal View)



This report shall not be reproduced except in full, without the written approval of KES Co., Ltd.  
The results shown in this test report refer only to the sample(s) tested unless otherwise stated.

## EUT Internal View – Main board

(Top)

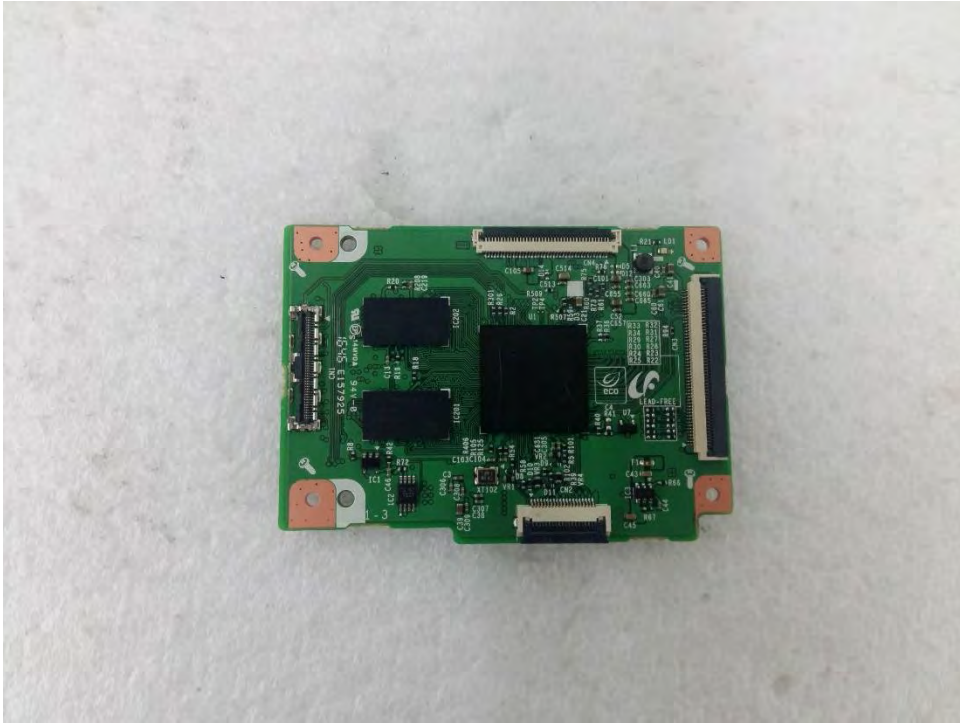

(Bottom)



This report shall not be reproduced except in full, without the written approval of KES Co., Ltd.  
The results shown in this test report refer only to the sample(s) tested unless otherwise stated.

## EUT Internal View – Sub board

(Top)



(Bottom)



This report shall not be reproduced except in full, without the written approval of KES Co., Ltd.  
The results shown in this test report refer only to the sample(s) tested unless otherwise stated.

## EUT Internal View – Switch Board

(Top)



(Bottom)



This report shall not be reproduced except in full, without the written approval of KES Co., Ltd.  
The results shown in this test report refer only to the sample(s) tested unless otherwise stated.



## EUT Internal View – Power Board

(Top)



(Bottom)



This report shall not be reproduced except in full, without the written approval of KES Co., Ltd.  
The results shown in this test report refer only to the sample(s) tested unless otherwise stated.

## EUT Internal View – Lens Board

(Top)

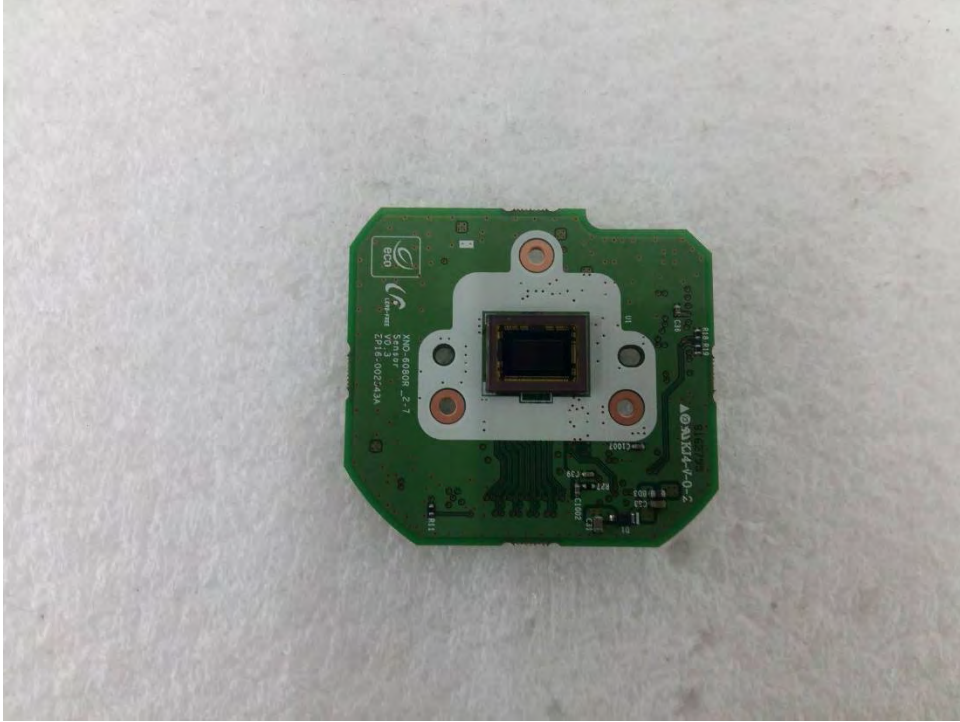

(Bottom)



This report shall not be reproduced except in full, without the written approval of KES Co., Ltd.  
The results shown in this test report refer only to the sample(s) tested unless otherwise stated.

---

## EUT Internal View Camera Lens

(Top)



(Bottom)



---

This report shall not be reproduced except in full, without the written approval of KES Co., Ltd.  
The results shown in this test report refer only to the sample(s) tested unless otherwise stated.

## Label and Location

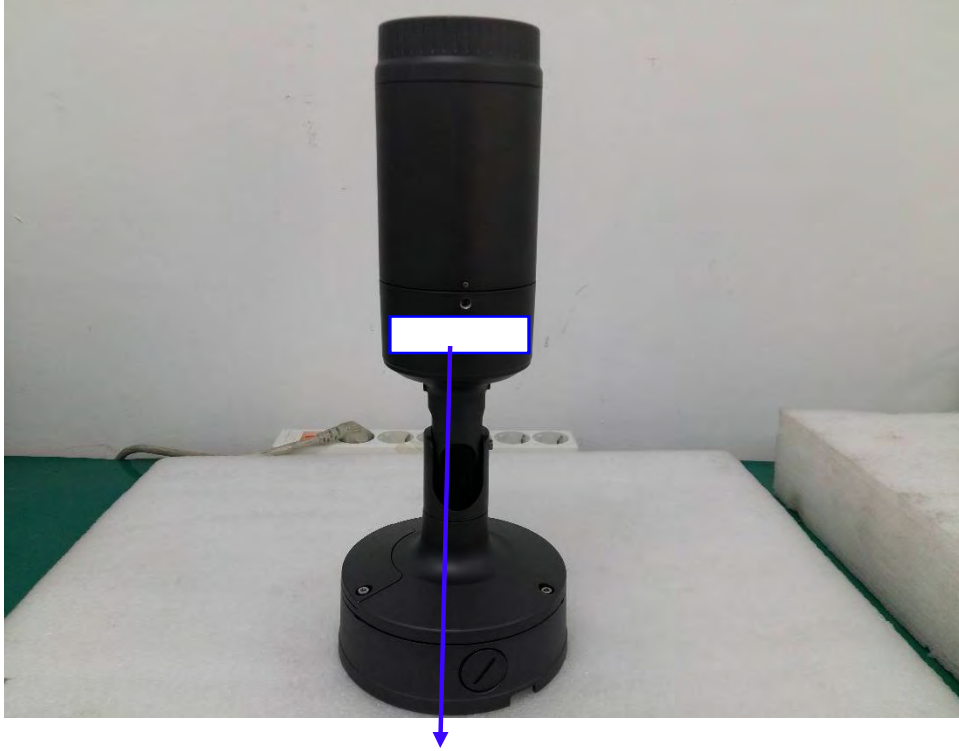

### **NETWORK CAMERA**

Model No : XNO-6080RP

Manufacturer : Tianjin Samsung Techwin Opto-Electronic Co., Ltd.

Made in of China



This report shall not be reproduced except in full, without the written approval of KES Co., Ltd.  
The results shown in this test report refer only to the sample(s) tested unless otherwise stated.