



iES4028F  
iES4028FP  
E072008/ST-R01  
14910000022A

## **COPYRIGHT**

This manual is proprietary to SAMSUNG Electronics Co., Ltd. and is protected by copyright.

No information contained herein may be copied, translated, transcribed or duplicated for any commercial purposes or disclosed to third parties in any form without the prior written consent of SAMSUNG Electronics Co., Ltd.

## **TRADEMARKS**

Ubigate iES4028F and Ubigate iES4028FP are registered trademarks of SAMSUNG Electronics.

All other company and product names may be trademarks of the respective companies with which they are associated.

This manual should be read before the installation and operation, and the operator should correctly install and operate the product by using this manual.

This manual should be read before the installation and operation, and the operator should correctly install and operate the product by using this manual.

This manual may be changed for the system improvement, standardization and other technical reasons without prior notice.

For further information on the updated manual or have a question for the content of manual, contact the homepage below.

Homepage: <http://www.samsungnetwork.com>

For A/S and Tech. support: <http://www.samsungnetwork.com>

For Manual: <http://www.samsungdocs.com>



**This page is intentionally left blank.**

# About This Guide

## Purpose

This guide gives specific information on how to operate and use the management functions of the switch.

## Audience

The guide is intended for use by network administrators who are responsible for operating and maintaining network equipment; consequently, it assumes a basic working knowledge of general switch functions, the Internet Protocol (IP), and Simple Network Management Protocol (SNMP).

## Conventions

The following conventions are used throughout this guide to show information:

**Note:** Emphasizes important information or calls your attention to related features or instructions.

**Caution:** Alerts you to a potential hazard that could cause loss of data, or damage the system or equipment.

**Warning:** Alerts you to a potential hazard that could cause personal injury.

## Related Publications

The following publication details the hardware features of the switch, including the physical and performance-related characteristics, and how to install the switch:

The *Installation Manual*

Also, as part of the switch's software, there is an online web-based help that describes all management related features.

## Revision History

This section summarizes the changes in each revision of this guide.

### July 2008 Revision

This is the second revision of this guide. It combines information for the Ubigate iES4028F and iES4028FP. This guide is valid for software release v1.1.0.13. Other than the addition of information about the iES4028F, it also includes the following updated and additional information in the indicated tables or sections:

- Table 1-1, "Key Features," on page 1-1.
- "Description of Software Features" on page 1-2.
- Table 1-2, "System Defaults," on page 1-6.
- "Dynamic Configuration" on page 2-5.

- “Managing System Files” on page 2-8.
- “Saving Configuration Settings” on page 2-9.
- “Configuring Power over Ethernet” on page 2-10.
- VLAN Learning under “Displaying Bridge Extension Capabilities” on page 3-16.
- Removal of default IP address under “Setting the Switch’s IP Address” on page 3-17.
- Change to jumbo frame size under “Enabling Jumbo Frames” on page 3-20.
- “Managing Firmware” on page 3-21.
- Command Usage and Command Attributes under “Specifying Trap Managers and Trap Types” on page 3-43.
- NAS IP Address under “Configuring Local/Remote Logon Authentication” on page 3-59.
- Size of Secret Text String under “Configuring Encryption Keys” on page 3-64.
- Private Password under “Replacing the Default Secure-site Certificate” on page 3-78.
- Public Key Type under “Importing User Public Keys” on page 3-84.
- Command Usage under “Configuring Port Security” on page 3-97.
- Notes under “Web Authentication” on page 3-98.
- Note under “Network Access (MAC Address Authentication)” on page 3-102.
- Guest VLAN, Dynamic VLAN, and removal of Dynamic QoS under “Configuring MAC Authentication for Ports” on page 3-104.
- Removed Security, Network Access, Port Link Detection Configuration web page.
- Command Usage under “Access Control Lists” on page 3-108.
- Removed references to static bindings for DHCP Snooping under “DHCP Snooping” on page 3-116.
- Command Usage and Command Attributes under “Configuring VLANs for DHCP Snooping” on page 3-118.
- Command Usage and Command Attributes under “Configuring the DHCP Snooping Information Option” on page 3-118.
- Command Usage under “Configuring Ports for DHCP Snooping” on page 3-120.
- Command Usage under “IP Source Guard” on page 3-123.
- Command Usage under “Configuring Static Binding for IP Source Guard” on page 3-124.
- Command Usage and Command Attributes under “Configuring Interface Connections” on page 3-129.
- “Configuring Parameters for LACP Groups” on page 3-139.
- Flooding Behavior Field Attributes under STA - “Displaying Global Settings” on page 3-164.
- Spanning Tree BPDU Flooding Command Attribute under STA - “Configuring Global Settings” on page 3-167.
- BPDU Flooding Field Attribute under “Displaying Interface Settings” on page 3-171.
- Admin Path Cost Command Attribute under “Configuring Interface Settings” on page 3-174.
- Forwarding Tagged/Untagged Frames under “IEEE 802.1Q VLANs” on page 3-183.
- Untagged Command Attribute under “Adding Static Members to VLANs (VLAN Index)” on page 3-191.
- Ingress Filtering Command Attribute under “Configuring VLAN Behavior for Interfaces” on page 3-194.
- Mode Access Command Attribute under “Configuring VLAN Behavior for Interfaces” on page 3-194.

- 802.1Q Tunnel Status Command Attribute under “Enabling QinQ Tunneling on the Switch” on page 3-200.
- “Traffic Segmentation” on page 3-202.
- Removed Isolated VLAN option from “Private VLANs” on page 3-204.
- Introduction and Command Usage under “Protocol VLANs” on page 3-210.
- Command Usage under “Configuring the Protocol VLAN System” on page 3-211.
- Field Attributes under “Displaying LLDP Local Device Information” on page 3-218.
- Field Attributes under “Displaying LLDP Remote Port Information” on page 3-220.
- Field Attributes under “Displaying LLDP Remote Information Details” on page 3-221.
- Introduction and Field Attributes under “Displaying Device Statistics” on page 3-223.
- Field Attributes under “Displaying Detailed Device Statistics” on page 3-225.
- Introduction, Command Usage and Command Attributes under “Selecting the Queue Mode” on page 3-230.
- Introduction under “Setting the Service Weight for Traffic Classes” on page 3-230.
- “Mapping Layer 3/4 Priorities to CoS Values” on page 3-231.
- Action Command Attribute under “Creating QoS Policies” on page 3-238.
- Introduction under “Multicast Filtering” on page 3-247.
- Introduction and Command Usage under “Enabling IGMP Immediate Leave” on page 3-251.
- New Multicast Address Range List Command Attribute under “Configuring IGMP Filter Profiles” on page 3-258.
- Command Usage and MVR Running Status Command Attribute under “Configuring Global MVR Settings” on page 3-262.
- Command Usage and Command Attributes under “Configuring MVR Interface Status” on page 3-266.
- Command Usage under “Switch Clustering” on page 3-269.
- Introduction under “UPnP” on page 3-273.
- Command Usage under “jumbo frame” on page 4-33.
- Command Usage under “copy” on page 4-35.
- Syntax under “show log” on page 4-55.
- Using Switch Clustering under “Switch Cluster Commands” on page 4-73.
- Introduction under “UPnP Commands” on page 4-77.
- “Debug Commands” on page 4-80.
- Syntax for “radius-server host” on page 4-105.
- Introduction, Default Setting and Command Usage under “radius-server attribute 4” on page 4-107.
- Syntax for “radius-server key” on page 4-107.
- Syntax for “tacacs-server host” on page 4-110.
- Syntax for “tacacs-server key” on page 4-111.
- Introduction for “aaa group server” on page 4-114.
- Syntax for “show accounting” on page 4-122.
- “ip telnet server” on page 4-126.
- Authentication section of Configuration Guidelines under “Secure Shell Commands” on page 4-127.
- Command Usage under “dot1x re-authenticate” on page 4-139.
- Command Usage under “dot1x re-authentication” on page 4-139.

- Command Usage under “port security” on page 4-148.
- Introduction under “Network Access (MAC Address Authentication)” on page 4-149.
- Removed network-access dynamic-qos, network-access link-detection, network-access link-detection link-down, network-access link-detection link-up, and network-access link-detection link-up-down commands from “Network Access (MAC Address Authentication)” on page 4-149.
- Removed web-auth login-fail-page-url, web-auth login-page-url, and web-auth login-success-page-url commands from “Web Authentication” on page 4-157.
- Command Usage under “ip dhcp snooping information option” on page 4-168.
- Removed reference to static DHCP Snooping entries from Command Usage under “ip source-guard” on page 4-171 and “ip source-guard binding” on page 4-173.
- Introduction, Syntax and Command Usage under “permit, deny (Extended ACL)” on page 4-178.
- Removed Command Usage from “ACL Information” on page 4-186.
- Command Usage under “speed-duplex” on page 4-188.
- “media-type” on page 4-192.
- “giga-phy-mode” on page 4-193.
- Default Setting under “switchport packet-rate” on page 4-194.
- “lACP active/passive” on page 4-208.
- Software Version parameter in Table 4-60, “show power mainpower parameters,” on page 4-217.
- Syntax and Command Usage under “port monitor” on page 4-218.
- “spanning-tree system-bpdu-flooding” on page 4-230.
- Syntax and Default Setting under “spanning-tree cost” on page 4-236.
- “spanning-tree port-bpdu-flooding” on page 4-239.
- Syntax and Default Setting under “spanning-tree mst cost” on page 4-243.
- Syntax for “switchport mode” on page 4-255.
- Removed note under “switchport ingress-filtering” on page 4-256.
- Removed note under “switchport allowed vlan” on page 4-258.
- Command Usage under “switchport allowed vlan” on page 4-258.
- Syntax for “show vlan” on page 4-260.
- Limitations for QinQ under “Configuring IEEE 802.1Q Tunneling” on page 4-261.
- Command Usage under “switchport dot1q-tunnel mode” on page 4-262.
- “Configuring Port-based Traffic Segmentation” on page 4-265.
- Removed references to isolated VLAN option from “Configuring Private VLANs” on page 4-269 and related commands which had supported this option.
- Removed switchport private-vlan isolated command.
- Command Usage under “switchport voice vlan” on page 4-280.
- Command Usage under “queue mode” on page 4-306.
- Removed queue bandwidth command.
- Configuration guidelines under “Quality of Service Commands” on page 4-313.
- Introduction and Syntax for “set” on page 4-318.
- Command Usage under “mvr (Global Configuration)” on page 4-339.
- Command Usage under “mvr (Interface Configuration)” on page 4-341.
- Command Usage under “ip default-gateway” on page 4-346.
- General Security Measures under “Software Specifications” on page A-1.



- Updated entries for Standards under “Software Specifications” on page A-1.
- Updated entries for Management Information Bases under “Software Specifications” on page A-1.

### **April 2008 Revision**

This was the first revision of this guide for the Ubigate iES4028FP.



**This page is intentionally left blank.**

# Contents

---

<b>Chapter 1: Introduction</b>	<b>1-1</b>
Key Features	1-1
Description of Software Features	1-2
System Defaults	1-6

---

<b>Chapter 2: Initial Configuration</b>	<b>2-1</b>
Connecting to the Switch	2-1
Configuration Options	2-1
Required Connections	2-2
Remote Connections	2-3
Basic Configuration	2-3
Console Connection	2-3
Setting Passwords	2-4
Setting an IP Address	2-4
Manual Configuration	2-5
Dynamic Configuration	2-5
Enabling SNMP Management Access	2-6
Community Strings (for SNMP version 1 and 2c clients)	2-7
Trap Receivers	2-7
Configuring Access for SNMP Version 3 Clients	2-8
Managing System Files	2-8
Saving Configuration Settings	2-9
Configuring Power over Ethernet	2-10

---

<b>Chapter 3: Configuring the Switch</b>	<b>3-1</b>
Using the Web Interface	3-1
Navigating the Web Browser Interface	3-2
Home Page	3-2
Configuration Options	3-3
Panel Display	3-3
Main Menu	3-4
Basic Configuration	3-12
Displaying System Information	3-12
Displaying Switch Hardware/Software Versions	3-14
Displaying Bridge Extension Capabilities	3-16
Setting the Switch's IP Address	3-17
Manual Configuration	3-18
Using DHCP/BOOTP	3-19
Enabling Jumbo Frames	3-20

Managing Firmware	3-21
Downloading System Software from a Server	3-22
Saving or Restoring Configuration Settings	3-23
Downloading Configuration Settings from a Server	3-24
Console Port Settings	3-25
Telnet Settings	3-27
Configuring Event Logging	3-29
System Log Configuration	3-29
Remote Log Configuration	3-30
Displaying Log Messages	3-32
Sending Simple Mail Transfer Protocol Alerts	3-32
Resetting the System	3-34
Setting the System Clock	3-35
Setting the Time Manually	3-36
Configuring SNTP	3-36
Configuring NTP	3-37
Setting the Time Zone	3-39
Simple Network Management Protocol	3-40
Enabling SNMP Agent Status	3-41
Setting Community Access Strings	3-42
Specifying Trap Managers and Trap Types	3-43
Configuring SNMPv3 Management Access	3-46
Setting the Local Engine ID	3-46
Specifying a Remote Engine ID	3-47
Configuring SNMPv3 Users	3-48
Configuring Remote SNMPv3 Users	3-50
Configuring SNMPv3 Groups	3-52
Setting SNMPv3 Views	3-55
User Authentication	3-57
Configuring User Accounts	3-58
Configuring Local/Remote Logon Authentication	3-59
Configuring Encryption Keys	3-64
AAA Authorization and Accounting	3-65
Configuring AAA RADIUS Group Settings	3-66
Configuring AAA TACACS+ Group Settings	3-67
Configuring AAA Accounting	3-67
AAA Accounting Update	3-69
AAA Accounting 802.1X Port Settings	3-70
AAA Accounting Exec Command Privileges	3-71
AAA Accounting Exec Settings	3-72
AAA Accounting Summary	3-72
Authorization Settings	3-74
Authorization EXEC Settings	3-75
Authorization Summary	3-76

Configuring HTTPS	3-77
Replacing the Default Secure-site Certificate	3-78
Configuring the Secure Shell	3-79
Generating the Host Key Pair	3-82
Importing User Public Keys	3-84
Configuring the SSH Server	3-86
Configuring 802.1X Port Authentication	3-88
Displaying 802.1X Global Settings	3-89
Configuring 802.1X Global Settings	3-90
Configuring Port Settings for 802.1X	3-90
Displaying 802.1X Statistics	3-93
Filtering IP Addresses for Management Access	3-94
General Security Measures	3-96
Configuring Port Security	3-97
Web Authentication	3-98
Configuring Web Authentication	3-99
Configuring Web Authentication for Ports	3-100
Displaying Web Authentication Port Information	3-101
Re-authenticating Web Authenticated Ports	3-101
Network Access (MAC Address Authentication)	3-102
Configuring the MAC Authentication Reauthentication Time	3-103
Configuring MAC Authentication for Ports	3-104
Displaying Secure MAC Address Information	3-106
MAC Authentication	3-107
Configuring MAC authentication parameters for ports	3-107
Access Control Lists	3-108
Setting the ACL Name and Type	3-109
Configuring a Standard IP ACL	3-110
Configuring an Extended IP ACL	3-111
Configuring a MAC ACL	3-113
Binding a Port to an Access Control List	3-115
DHCP Snooping	3-116
Configuring DHCP Snooping	3-117
Configuring VLANs for DHCP Snooping	3-118
Configuring the DHCP Snooping Information Option	3-118
Configuring Ports for DHCP Snooping	3-120
Displaying DHCP Snooping Binding Information	3-122
IP Source Guard	3-123
Configuring Ports for IP Source Guard	3-123
Configuring Static Binding for IP Source Guard	3-124
Displaying Information for Dynamic IP Source Guard Bindings	3-126
Port Configuration	3-127
Displaying Connection Status	3-127
Configuring Interface Connections	3-129

Creating Trunk Groups	3-132
Statically Configuring a Trunk	3-133
Enabling LACP on Selected Ports	3-134
Configuring Parameters for LACP Group Members	3-136
Configuring Parameters for LACP Groups	3-139
Displaying LACP Port Counters	3-140
Displaying LACP Settings and Status for the Local Side	3-141
Displaying LACP Settings and Status for the Remote Side	3-143
Setting Broadcast Storm Thresholds	3-145
Configuring Port Mirroring	3-147
Configuring Rate Limits	3-148
Rate Limit Configuration	3-148
Showing Port Statistics	3-149
Power Over Ethernet Settings	3-153
Switch Power Status	3-154
Setting a Switch Power Budget	3-155
Displaying Port Power Status	3-155
Configuring Port PoE Power	3-156
Address Table Settings	3-158
Setting Static Addresses	3-158
Displaying the Address Table	3-159
Changing the Aging Time	3-160
Spanning Tree Algorithm Configuration	3-161
Configuring Port and Trunk Loopback Detection	3-163
Displaying Global Settings	3-164
Configuring Global Settings	3-167
Displaying Interface Settings	3-171
Configuring Interface Settings	3-174
Configuring Multiple Spanning Trees	3-177
Displaying Interface Settings for MSTP	3-180
Configuring Interface Settings for MSTP	3-182
VLAN Configuration	3-183
IEEE 802.1Q VLANs	3-183
Enabling or Disabling GVRP (Global Setting)	3-186
Displaying Basic VLAN Information	3-187
Displaying Current VLANs	3-188
Creating VLANs	3-189
Adding Static Members to VLANs (VLAN Index)	3-191
Adding Static Members to VLANs (Port Index)	3-193
Configuring VLAN Behavior for Interfaces	3-194
Configuring IEEE 802.1Q Tunneling	3-196
Enabling QinQ Tunneling on the Switch	3-200
Adding an Interface to a QinQ Tunnel	3-201
Traffic Segmentation	3-202
Configuring Global Settings for Traffic Segmentation	3-202

Configuring Traffic Segmentation Sessions	3-203
Private VLANs	3-204
Displaying Current Private VLANs	3-205
Configuring Private VLANs	3-206
Associating VLANs	3-207
Displaying Private VLAN Interface Information	3-207
Configuring Private VLAN Interfaces	3-208
Protocol VLANs	3-210
Configuring Protocol VLAN Groups	3-210
Configuring the Protocol VLAN System	3-211
Link Layer Discovery Protocol	3-212
Setting LLDP Timing Attributes	3-213
Configuring LLDP Interface Attributes	3-215
Displaying LLDP Local Device Information	3-218
Displaying LLDP Remote Port Information	3-220
Displaying LLDP Remote Information Details	3-221
Displaying Device Statistics	3-223
Displaying Detailed Device Statistics	3-225
Class of Service Configuration	3-226
Layer 2 Queue Settings	3-226
Setting the Default Priority for Interfaces	3-226
Mapping CoS Values to Egress Queues	3-228
Selecting the Queue Mode	3-230
Setting the Service Weight for Traffic Classes	3-230
Layer 3/4 Priority Settings	3-231
Mapping Layer 3/4 Priorities to CoS Values	3-231
Enabling IP DSCP Priority	3-232
Mapping DSCP Priority	3-233
Quality of Service	3-234
Configuring Quality of Service Parameters	3-235
Configuring a Class Map	3-235
Creating QoS Policies	3-238
Attaching a Policy Map to Ingress Queues	3-241
VoIP Traffic Configuration	3-242
Configuring VoIP Traffic	3-242
Configuring VoIP Traffic Ports	3-243
Configuring Telephony OUI	3-245
Multicast Filtering	3-247
Layer 2 IGMP (Snooping and Query)	3-248
Configuring IGMP Snooping and Query Parameters	3-249
Enabling IGMP Immediate Leave	3-251
Displaying Interfaces Attached to a Multicast Router	3-252
Specifying Static Interfaces for a Multicast Router	3-253
Displaying Port Members of Multicast Services	3-254
Assigning Ports to Multicast Services	3-255

IGMP Filtering and Throttling	3-256
Enabling IGMP Filtering	3-257
Configuring IGMP Filter Profiles	3-258
Configuring IGMP Filtering and Throttling for Interfaces	3-259
Multicast VLAN Registration	3-261
Configuring Global MVR Settings	3-262
Displaying MVR Interface Status	3-264
Displaying Port Members of Multicast Groups	3-265
Configuring MVR Interface Status	3-266
Assigning Static Multicast Groups to Interfaces	3-267
Switch Clustering	3-269
Configuring General Settings for Clusters	3-269
Configuring Cluster Members	3-270
Displaying Information on Cluster Members	3-271
Displaying Information on Cluster Candidates	3-272
UPnP	3-273
UPnP Configuration	3-274
<hr/>	
<b>Chapter 4: Command Line Interface</b>	<b>4-1</b>
Using the Command Line Interface	4-1
Accessing the CLI	4-1
Console Connection	4-1
Telnet Connection	4-2
Entering Commands	4-3
Keywords and Arguments	4-3
Minimum Abbreviation	4-3
Command Completion	4-3
Getting Help on Commands	4-3
Showing Commands	4-4
Partial Keyword Lookup	4-5
Negating the Effect of Commands	4-5
Using Command History	4-5
Understanding Command Modes	4-5
Exec Commands	4-6
Configuration Commands	4-7
Command Line Processing	4-8
Command Groups	4-9
General Commands	4-10
enable	4-11
disable	4-11
configure	4-12
show history	4-12
reload	4-13
show reload	4-14



prompt	4-14
end	4-15
exit	4-15
quit	4-16
System Management Commands	4-16
Device Designation Commands	4-17
hostname	4-17
Banner Information Commands	4-18
banner configure	4-18
banner configure company	4-19
banner configure dc-power-info	4-20
banner configure department	4-21
banner configure equipment-info	4-21
banner configure equipment-location	4-22
banner configure ip-lan	4-23
banner configure ip-number	4-23
banner configure manager-info	4-24
banner configure mux	4-25
banner configure note	4-25
show banner	4-26
System Status Commands	4-27
show startup-config	4-27
show running-config	4-29
show system	4-31
show users	4-31
show version	4-32
Frame Size Commands	4-33
jumbo frame	4-33
File Management Commands	4-34
copy	4-35
delete	4-37
dir	4-38
whichboot	4-39
boot system	4-39
Line Commands	4-40
line	4-41
login	4-41
password	4-42
timeout login response	4-43
exec-timeout	4-44
password-thresh	4-44
silent-time	4-45
databits	4-46
parity	4-46
speed	4-47

stopbits	4-47
disconnect	4-48
show line	4-48
Event Logging Commands	4-49
logging on	4-49
logging history	4-50
logging host	4-51
logging facility	4-51
logging trap	4-52
clear log	4-53
show logging	4-53
show log	4-55
SMTP Alert Commands	4-56
logging sendmail host	4-56
logging sendmail level	4-57
logging sendmail source-email	4-57
logging sendmail destination-email	4-58
logging sendmail	4-58
show logging sendmail	4-58
Time Commands	4-59
sntp client	4-60
sntp server	4-61
sntp poll	4-61
show sntp	4-62
ntp client	4-62
ntp server	4-63
ntp poll	4-64
ntp authenticate	4-64
ntp authentication-key	4-65
show ntp	4-66
clock timezone-predefined	4-67
clock timezone	4-67
clock summer-time (date)	4-68
clock summer-time (predefined)	4-69
clock summer-time (recurring)	4-70
calendar set	4-72
show calendar	4-72
Switch Cluster Commands	4-73
cluster	4-73
cluster commander	4-74
cluster ip-pool	4-75
cluster member	4-75
rcommand	4-76
show cluster	4-76
show cluster members	4-77

show cluster candidates	4-77
UPnP Commands	4-77
upnp device	4-78
upnp device ttl	4-78
upnp device advertise duration	4-79
show upnp	4-79
Debug Commands	4-80
debug dot1x	4-80
debug radius	4-82
debug tacacs	4-84
SNMP Commands	4-86
snmp-server	4-86
show snmp	4-87
snmp-server community	4-88
snmp-server contact	4-88
snmp-server location	4-89
snmp-server host	4-90
snmp-server enable traps	4-92
snmp-server engine-id	4-93
show snmp engine-id	4-94
snmp-server view	4-94
show snmp view	4-95
snmp-server group	4-96
show snmp group	4-97
snmp-server user	4-98
show snmp user	4-99
Authentication Commands	4-100
User Account Commands	4-100
username	4-101
enable password	4-102
Authentication Sequence	4-103
authentication login	4-103
authentication enable	4-104
RADIUS Client	4-105
radius-server host	4-105
radius-server auth-port	4-106
radius-server acct-port	4-106
radius-server attribute 4	4-107
radius-server key	4-107
radius-server retransmit	4-108
radius-server timeout	4-108
show radius-server	4-109
TACACS+ Client	4-109
tacacs-server host	4-110
tacacs-server port	4-110

tacacs-server key	4-111
tacacs-server retransmit	4-111
tacacs-server timeout	4-112
show tacacs-server	4-113
AAA Commands	4-114
aaa group server	4-114
server	4-115
aaa accounting dot1x	4-116
aaa accounting exec	4-117
aaa accounting commands	4-118
aaa accounting update	4-119
accounting dot1x	4-119
accounting exec	4-120
accounting commands	4-120
aaa authorization exec	4-121
authorization exec	4-122
show accounting	4-122
Web Server Commands	4-123
ip http port	4-123
ip http server	4-124
ip http secure-server	4-124
ip http secure-port	4-125
Telnet Server Commands	4-126
ip telnet server	4-126
Secure Shell Commands	4-127
ip ssh server	4-129
ip ssh timeout	4-130
ip ssh authentication-retries	4-130
ip ssh server-key size	4-131
delete public-key	4-131
ip ssh crypto host-key generate	4-132
ip ssh crypto zeroize	4-132
ip ssh save host-key	4-133
show ip ssh	4-133
show ssh	4-134
show public-key	4-135
802.1X Port Authentication	4-136
dot1x system-auth-control	4-136
dot1x default	4-137
dot1x max-req	4-137
dot1x port-control	4-137
dot1x operation-mode	4-138
dot1x re-authenticate	4-139
dot1x re-authentication	4-139
dot1x timeout quiet-period	4-140

dot1x timeout re-authperiod	4-140
dot1x timeout tx-period	4-141
dot1x intrusion-action	4-141
show dot1x	4-142
Management IP Filter Commands	4-145
management	4-145
show management	4-146
General Security Measures	4-147
Port Security Commands	4-148
port security	4-148
Network Access (MAC Address Authentication)	4-149
network-access aging	4-150
network-access mode	4-151
network-access max-mac-count	4-152
network-access dynamic-vlan	4-152
network-access guest-vlan	4-153
mac-authentication reauth-time	4-154
mac-authentication intrusion-action	4-154
mac-authentication max-mac-count	4-155
clear network-access	4-155
show network-access	4-156
show network-access mac-address-table	4-156
Web Authentication	4-157
web-auth login-attempts	4-158
web-auth quiet-period	4-158
web-auth session-timeout	4-159
web-auth system-auth-control	4-159
web-auth	4-160
web-auth re-authenticate (Port)	4-160
web-auth re-authenticate (IP)	4-161
show web-auth	4-161
show web-auth interface	4-162
show web-auth summary	4-163
DHCP Snooping Commands	4-163
ip dhcp snooping	4-164
ip dhcp snooping vlan	4-165
ip dhcp snooping trust	4-166
ip dhcp snooping verify mac-address	4-167
ip dhcp snooping information option	4-168
ip dhcp snooping information policy	4-169
ip dhcp snooping database flash	4-169
clear ip dhcp snooping database flash	4-170
show ip dhcp snooping	4-170
show ip dhcp snooping binding	4-170

IP Source Guard Commands	4-171
ip source-guard	4-171
ip source-guard binding	4-173
show ip source-guard	4-174
show ip source-guard binding	4-174
Access Control List Commands	4-175
IP ACLs	4-175
access-list ip	4-176
permit, deny (Standard ACL)	4-177
permit, deny (Extended ACL)	4-178
show ip access-list	4-180
ip access-group	4-180
show ip access-group	4-181
MAC ACLs	4-181
access-list mac	4-182
permit, deny (MAC ACL)	4-183
show mac access-list	4-184
mac access-group	4-185
show mac access-group	4-185
ACL Information	4-186
show access-list	4-186
show access-group	4-186
Interface Commands	4-187
interface	4-187
description	4-188
speed-duplex	4-188
negotiation	4-189
capabilities	4-190
flowcontrol	4-191
media-type	4-192
giga-phy-mode	4-193
shutdown	4-194
switchport packet-rate	4-194
clear counters	4-195
show interfaces status	4-196
show interfaces counters	4-198
show interfaces switchport	4-199
Link Aggregation Commands	4-201
channel-group	4-202
lACP	4-203
lACP system-priority	4-204
lACP admin-key (Ethernet Interface)	4-205
lACP admin-key (Port Channel)	4-206
lACP port-priority	4-207
lACP active/passive	4-208

show lacp	4-208
Power over Ethernet Commands	4-212
power mainpower maximum allocation	4-213
power inline compatible	4-213
power inline	4-214
power inline maximum allocation	4-215
power inline priority	4-215
show power inline status	4-216
show power mainpower	4-217
Mirror Port Commands	4-218
port monitor	4-218
show port monitor	4-219
Rate Limit Commands	4-220
rate-limit	4-220
Address Table Commands	4-221
mac-address-table static	4-221
clear mac-address-table dynamic	4-222
show mac-address-table	4-223
mac-address-table aging-time	4-224
show mac-address-table aging-time	4-224
Spanning Tree Commands	4-225
spanning-tree	4-226
spanning-tree mode	4-227
spanning-tree forward-time	4-228
spanning-tree hello-time	4-228
spanning-tree max-age	4-229
spanning-tree priority	4-230
spanning-tree system-bpdu-flooding	4-230
spanning-tree pathcost method	4-231
spanning-tree transmission-limit	4-231
spanning-tree mst configuration	4-232
mst vlan	4-232
mst priority	4-233
name	4-234
revision	4-234
max-hops	4-235
spanning-tree spanning-disabled	4-235
spanning-tree cost	4-236
spanning-tree port-priority	4-237
spanning-tree edge-port	4-238
spanning-tree portfast	4-239
spanning-tree port-bpdu-flooding	4-239
spanning-tree link-type	4-240
spanning-tree loopback-detection	4-241
spanning-tree loopback-detection release-mode	4-241

spanning-tree loopback-detection trap	4-242
spanning-tree mst cost	4-243
spanning-tree mst port-priority	4-244
spanning-tree protocol-migration	4-244
show spanning-tree	4-245
show spanning-tree mst configuration	4-247
VLAN Commands	4-247
GVRP and Bridge Extension Commands	4-248
bridge-ext gvrp	4-248
show bridge-ext	4-249
switchport gvrp	4-249
show gvrp configuration	4-250
garp timer	4-250
show garp timer	4-251
Editing VLAN Groups	4-252
vlan database	4-252
vlan	4-253
Configuring VLAN Interfaces	4-254
interface vlan	4-254
switchport mode	4-255
switchport acceptable-frame-types	4-255
switchport ingress-filtering	4-256
switchport native vlan	4-257
switchport allowed vlan	4-258
switchport forbidden vlan	4-259
Displaying VLAN Information	4-260
show vlan	4-260
Configuring IEEE 802.1Q Tunneling	4-261
dot1q-tunnel system-tunnel-control	4-262
switchport dot1q-tunnel mode	4-262
switchport dot1q-tunnel tpid	4-263
show dot1q-tunnel	4-264
Configuring Port-based Traffic Segmentation	4-265
pvlan	4-265
pvlan uplink/downlink	4-266
pvlan session	4-267
pvlan up-to-up	4-268
show pvlan	4-268
Configuring Private VLANs	4-269
private-vlan	4-270
private vlan association	4-271
switchport mode private-vlan	4-271
switchport private-vlan host-association	4-272
switchport private-vlan mapping	4-273
show vlan private-vlan	4-273



Configuring Protocol-based VLANs	4-274
protocol-vlan protocol-group (Configuring Groups)	4-275
protocol-vlan protocol-group (Configuring VLANs)	4-275
show protocol-vlan protocol-group	4-276
show protocol-vlan protocol-group-vid	4-277
Configuring Voice VLANs	4-277
voice vlan	4-278
voice vlan aging	4-278
voice vlan mac-address	4-279
switchport voice vlan	4-280
switchport voice vlan rule	4-281
switchport voice vlan security	4-281
switchport voice vlan priority	4-282
show voice vlan	4-283
LLDP Commands	4-284
lldp	4-286
lldp holdtime-multiplier	4-286
lldp medFastStartCount	4-287
lldp notification-interval	4-287
lldp refresh-interval	4-288
lldp reinit-delay	4-288
lldp tx-delay	4-289
lldp admin-status	4-290
lldp notification	4-290
lldp mednotification	4-291
lldp basic-tlv management-ip-address	4-292
lldp basic-tlv port-description	4-292
lldp basic-tlv system-capabilities	4-293
lldp basic-tlv system-description	4-293
lldp basic-tlv system-name	4-294
lldp dot1-tlv proto-ident	4-294
lldp dot1-tlv proto-vid	4-295
lldp dot1-tlv pvid	4-295
lldp dot1-tlv vlan-name	4-296
lldp dot3-tlv link-agg	4-296
lldp dot3-tlv mac-phy	4-297
lldp dot3-tlv max-frame	4-297
lldp dot3-tlv poe	4-298
lldp medtlv extpoe	4-298
lldp medtlv inventory	4-299
lldp medtlv location	4-299
lldp medtlv med-cap	4-300
lldp medtlv network-policy	4-300
show lldp config	4-301
show lldp info local-device	4-303

show lldp info remote-device	4-304
show lldp info statistics	4-305
Class of Service Commands	4-306
Priority Commands (Layer 2)	4-306
queue mode	4-306
switchport priority default	4-307
queue cos-map	4-308
show queue mode	4-309
show queue bandwidth	4-309
show queue cos-map	4-310
Priority Commands (Layer 3 and 4)	4-311
map ip dscp (Global Configuration)	4-311
map ip dscp (Interface Configuration)	4-311
show map ip dscp	4-312
Quality of Service Commands	4-313
class-map	4-314
match	4-315
policy-map	4-316
class	4-317
set	4-318
police	4-319
service-policy	4-320
show class-map	4-320
show policy-map	4-321
show policy-map interface	4-321
Multicast Filtering Commands	4-322
IGMP Snooping Commands	4-322
ip igmp snooping	4-323
ip igmp snooping vlan static	4-323
ip igmp snooping version	4-324
ip igmp snooping leave-proxy	4-324
ip igmp snooping immediate-leave	4-325
show ip igmp snooping	4-326
show mac-address-table multicast	4-326
IGMP Query Commands (Layer 2)	4-327
ip igmp snooping querier	4-327
ip igmp snooping query-count	4-328
ip igmp snooping query-interval	4-328
ip igmp snooping query-max-response-time	4-329
ip igmp snooping router-port-expire-time	4-330
Static Multicast Routing Commands	4-330
ip igmp snooping vlan mrouter	4-331
show ip igmp snooping mrouter	4-331
IGMP Filtering and Throttling Commands	4-332
ip igmp filter (Global Configuration)	4-333

ip igmp profile	4-333
permit, deny	4-334
range	4-334
ip igmp filter (Interface Configuration)	4-335
ip igmp max-groups	4-336
ip igmp max-groups action	4-336
show ip igmp filter	4-337
show ip igmp profile	4-338
show ip igmp throttle interface	4-338
Multicast VLAN Registration Commands	4-339
mvr (Global Configuration)	4-339
mvr (Interface Configuration)	4-341
show mvr	4-342
IP Interface Commands	4-345
ip address	4-345
ip default-gateway	4-346
ip dhcp restart	4-347
show ip interface	4-347
show ip redirects	4-348
ping	4-348
<hr/>	
<b>Appendix A: Software Specifications</b>	<b>A-1</b>
Software Features	A-1
Management Features	A-2
Standards	A-2
Management Information Bases	A-3
<hr/>	
<b>Appendix B: Troubleshooting</b>	<b>B-1</b>
Problems Accessing the Management Interface	B-1
Using System Logs	B-2

## Glossary

## Index



**This page is intentionally left blank.**

# Tables

---

Table 1-1	Key Features	1-1
Table 1-2	System Defaults	1-6
Table 3-1	Configuration Options	3-3
Table 3-2	Main Menu	3-4
Table 3-3	Logging Levels	3-29
Table 3-5	Supported Notification Messages	3-52
Table 3-6	HTTPS System Support	3-77
Table 3-7	802.1X Statistics	3-93
Table 3-8	LACP Port Counters	3-140
Table 3-9	LACP Internal Configuration Information	3-141
Table 3-10	LACP Neighbor Configuration Information	3-143
Table 3-11	Port Statistics	3-149
Table 3-12	Recommended STA Path Cost Range	3-175
Table 3-13	Recommended STA Path Costs	3-175
Table 3-14	Default STA Path Costs	3-176
Table 3-15	Chassis ID Subtype	3-218
Table 3-16	System Capabilities	3-218
Table 3-17	Port ID Subtype	3-221
Table 3-18	Mapping CoS Values to Egress Queues	3-228
Table 3-19	CoS Priority Levels	3-228
Table 3-20	Mapping DSCP Priority Values	3-233
Table 4-1	Command Modes	4-6
Table 4-2	Configuration Modes	4-7
Table 4-3	Command Line Processing	4-8
Table 4-4	Command Groups	4-9
Table 4-5	General Commands	4-10
Table 4-6	System Management Commands	4-16
Table 4-7	Device Designation Commands	4-17
Table 4-8	Banner Commands	4-18
Table 4-9	System Status Commands	4-27
Table 4-10	Frame Size Commands	4-33
Table 4-11	Flash/File Commands	4-34
Table 4-12	File Directory Information	4-38
Table 4-13	Line Commands	4-40
Table 4-14	Event Logging Commands	4-49
Table 4-15	Logging Levels	4-50
Table 4-16	show logging flash/ram - display description	4-54
Table 4-17	show logging trap - display description	4-54
Table 4-18	SMTP Alert Commands	4-56
Table 4-19	Time Commands	4-59
Table 4-20	Predefined Summer-Time Parameters	4-70
Table 4-21	Switch Cluster Commands	4-73

Table 4-22	Debug Commands	4-80
Table 4-23	SNMP Commands	4-86
Table 4-24	show snmp engine-id - display description	4-94
Table 4-25	show snmp view - display description	4-95
Table 4-26	show snmp group - display description	4-98
Table 4-28	Authentication Commands	4-100
Table 4-29	User Access Commands	4-100
Table 4-27	show snmp user - display description	4-100
Table 4-30	Default Login Settings	4-101
Table 4-31	Authentication Sequence	4-103
Table 4-32	RADIUS Client Commands	4-105
Table 4-33	TACACS Commands	4-109
Table 4-34	Web Server Commands	4-123
Table 4-35	HTTPS System Support	4-125
Table 4-36	Telnet Server Commands	4-126
Table 4-37	SSH Commands	4-127
Table 4-38	show ssh - display description	4-134
Table 4-39	802.1X Port Authentication	4-136
Table 4-40	IP Filter Commands	4-145
Table 4-41	Client Security Commands	4-147
Table 4-42	Port Security Commands	4-148
Table 4-43	Network Access	4-149
Table 4-44	Web Authentication	4-157
Table 4-45	DHCP Snooping Commands	4-163
Table 4-46	IP Source Guard Commands	4-171
Table 4-47	Access Control Lists	4-175
Table 4-48	IP ACLs	4-175
Table 4-49	MAC ACL Commands	4-181
Table 4-50	ACL Information	4-186
Table 4-51	Interface Commands	4-187
Table 4-52	Interfaces Switchport Statistics	4-200
Table 4-53	Link Aggregation Commands	4-201
Table 4-54	show lacp counters - display description	4-209
Table 4-55	show lacp internal - display description	4-210
Table 4-56	show lacp neighbors - display description	4-211
Table 4-57	show lacp sysid - display description	4-212
Table 4-61	Mirror Port Commands	4-218
Table 4-62	Rate Limit Commands	4-220
Table 4-63	Address Table Commands	4-221
Table 4-64	Spanning Tree Commands	4-225
Table 4-65	Port Type	4-236
Table 4-65	IEEE 802.1D-1998	4-236
Table 4-65	IEEE 802.1w-2001	4-236
Table 4-66	Port Type	4-236
Table 4-66	Link Type	4-236

Table 4-66	IEEE 802.1D-1998	4-236
Table 4-66	IEEE 802.1w-2001	4-236
Table 4-67	Default STA Path Costs	4-237
Table 4-68	VLANs	4-247
Table 4-69	GVRP and Bridge Extension Commands	4-248
Table 4-70	Editing VLAN Groups	4-252
Table 4-71	Configuring VLAN Interfaces	4-254
Table 4-72	Show VLAN Commands	4-260
Table 4-73	IEEE 802.1Q Tunneling Commands	4-261
Table 4-74	Traffic Segmentation Commands	4-265
Table 4-75	Traffic Segmentation Forwarding	4-266
Table 4-76	Private VLAN Commands	4-269
Table 4-77	Protocol-based VLAN Commands	4-274
Table 4-78	Voice VLAN Commands	4-277
Table 4-79	LLDP Commands	4-284
Table 4-80	Priority Commands	4-306
Table 4-81	Priority Commands (Layer 2)	4-306
Table 4-82	Default CoS Values to Egress Queues	4-308
Table 4-83	Priority Commands (Layer 3 and 4)	4-311
Table 4-84	IP DSCP to CoS Values	4-312
Table 4-85	Quality of Service Commands	4-313
Table 4-86	Multicast Filtering Commands	4-322
Table 4-87	IGMP Snooping Commands	4-322
Table 4-88	IGMP Query Commands (Layer 2)	4-327
Table 4-89	Static Multicast Routing Commands	4-330
Table 4-90	IGMP Filtering and Throttling Commands	4-332
Table 4-91	Multicast VLAN Registration Commands	4-339
Table 4-92	show mvr - display description	4-343
Table 4-93	show mvr interface - display description	4-343
Table 4-94	show mvr members - display description	4-344
Table 4-95	IP Interface Commands	4-345
Table B-1	Troubleshooting Chart	B-1



**This page is intentionally left blank.**



# Figures

---

Figure 3-1	Home Page	3-2
Figure 3-2	Panel Display	3-3
Figure 3-3	System Information	3-13
Figure 3-4	Switch Information	3-14
Figure 3-5	Bridge Extension Configuration	3-16
Figure 3-6	Manual IP Configuration	3-18
Figure 3-7	DHCP IP Configuration	3-19
Figure 3-8	Jumbo Frames Configuration	3-20
Figure 3-9	Copy Firmware	3-22
Figure 3-10	Deleting Files	3-22
Figure 3-11	Downloading Configuration Settings for Startup	3-24
Figure 3-12	Setting the Startup Configuration Settings	3-24
Figure 3-13	Console Port Settings	3-26
Figure 3-14	Enabling Telnet	3-28
Figure 3-15	System Logs	3-30
Figure 3-16	Remote Logs	3-31
Figure 3-17	Displaying Logs	3-32
Figure 3-18	Enabling and Configuring SMTP	3-33
Figure 3-19	Resetting the System	3-35
Figure 3-20	SNTP Configuration	3-36
Figure 3-21	NTP Client Configuration	3-38
Figure 3-22	Setting the System Clock	3-39
Figure 3-23	Enabling SNMP Agent Status	3-41
Figure 3-24	Configuring SNMP Community Strings	3-42
Figure 3-25	Configuring IP Trap Managers	3-45
Figure 3-26	Setting an Engine ID	3-46
Figure 3-27	Setting a Remote Engine ID	3-47
Figure 3-28	Configuring SNMPv3 Users	3-49
Figure 3-29	Configuring Remote SNMPv3 Users	3-51
Figure 3-30	Configuring SNMPv3 Groups	3-54
Figure 3-31	Configuring SNMPv3 Views	3-56
Figure 3-32	Access Levels	3-58
Figure 3-33	Authentication Settings	3-62
Figure 3-34	Encryption Key Settings	3-65
Figure 3-35	AAA Radius Group Settings	3-66
Figure 3-36	AAA TACACS+ Group Settings	3-67
Figure 3-37	AAA Accounting Settings	3-68
Figure 3-38	AAA Accounting Update	3-69
Figure 3-39	AAA Accounting 802.1X Port Settings	3-70
Figure 3-40	AAA Accounting Exec Command Privileges	3-71
Figure 3-41	AAA Accounting Exec Settings	3-72
Figure 3-42	AAA Accounting Summary	3-73

Figure 3-43	AAA Authorization Settings	3-74
Figure 3-44	AAA Authorization Exec Settings	3-75
Figure 3-45	AAA Authorization Summary	3-76
Figure 3-46	HTTPS Settings	3-78
Figure 3-47	HTTPS Settings	3-79
Figure 3-48	SSH Host-Key Settings	3-83
Figure 3-49	SSH User Public-Key Settings	3-85
Figure 3-50	SSH Server Settings	3-87
Figure 3-51	802.1X Global Information	3-89
Figure 3-52	802.1X Global Configuration	3-90
Figure 3-53	802.1X Port Configuration	3-91
Figure 3-54	Displaying 802.1X Port Statistics	3-94
Figure 3-55	Creating an IP Filter List	3-95
Figure 3-56	Configuring Port Security	3-98
Figure 3-57	Web Authentication Configuration	3-99
Figure 3-58	Web Authentication Port Configuration	3-100
Figure 3-59	Web Authentication Port Information	3-101
Figure 3-60	Web Authentication Port Re-authentication	3-102
Figure 3-61	Network Access Configuration	3-103
Figure 3-62	Network Access Port Configuration	3-105
Figure 3-63	Network Access MAC Address Information	3-106
Figure 3-64	MAC Authentication Port Configuration	3-108
Figure 3-65	Selecting ACL Type	3-109
Figure 3-66	Configuring Standard IP ACLs	3-110
Figure 3-67	Configuring Extended IP ACLs	3-112
Figure 3-68	Configuring MAC ACLs	3-114
Figure 3-69	Configuring ACL Port Binding	3-115
Figure 3-70	DHCP Snooping Configuration	3-117
Figure 3-71	DHCP Snooping VLAN Configuration	3-118
Figure 3-72	DHCP Snooping Information Option Configuration	3-119
Figure 3-73	DHCP Snooping Port Configuration	3-121
Figure 3-74	DHCP Snooping Binding Information	3-122
Figure 3-75	IP Source Guard Port Configuration	3-124
Figure 3-76	Static IP Source Guard Binding Configuration	3-125
Figure 3-77	Dynamic IP Source Guard Binding Information	3-126
Figure 3-78	Displaying Port/Trunk Information	3-127
Figure 3-79	Port/Trunk Configuration	3-131
Figure 3-80	Configuring Static Trunks	3-133
Figure 3-81	LACP Trunk Configuration	3-135
Figure 3-82	LACP Port Configuration	3-138
Figure 3-83	LACP Aggregation Group Configuration	3-140
Figure 3-84	LACP - Port Counters Information	3-141
Figure 3-85	LACP - Port Internal Information	3-142
Figure 3-86	LACP - Port Neighbors Information	3-144
Figure 3-87	Port Broadcast Control	3-146

Figure 3-88	Mirror Port Configuration	3-147
Figure 3-89	Input Rate Limit Port Configuration	3-148
Figure 3-90	Port Statistics	3-152
Figure 3-91	Displaying the Global PoE Status	3-154
Figure 3-92	Setting the Switch Power Budget	3-155
Figure 3-93	Displaying Port PoE Status	3-156
Figure 3-94	Configuring Port PoE Power	3-157
Figure 3-95	Configuring a Static Address Table	3-158
Figure 3-96	Configuring a Dynamic Address Table	3-159
Figure 3-97	Setting the Address Aging Time	3-160
Figure 3-98	Configuring Port Loopback Detection	3-163
Figure 3-99	Displaying Spanning Tree Information	3-166
Figure 3-100	Configuring Spanning Tree	3-170
Figure 3-101	Displaying Spanning Tree Port Information	3-173
Figure 3-102	Configuring Spanning Tree per Port	3-177
Figure 3-103	Configuring Multiple Spanning Trees	3-178
Figure 3-104	Displaying MSTP Interface Settings	3-180
Figure 3-105	Displaying MSTP Interface Settings	3-183
Figure 3-106	Globally Enabling GVRP	3-186
Figure 3-107	Displaying Basic VLAN Information	3-187
Figure 3-108	Displaying Current VLANs	3-188
Figure 3-109	Configuring a VLAN Static List	3-190
Figure 3-110	Configuring a VLAN Static Table	3-192
Figure 3-111	VLAN Static Membership by Port	3-193
Figure 3-112	Configuring VLANs per Port	3-196
Figure 3-113	802.1Q Tunnel Status and Ethernet Type	3-201
Figure 3-114	Tunnel Port Configuration	3-202
Figure 3-115	Traffic Segmentation Status Configuration	3-203
Figure 3-116	Traffic Segmentation Session Configuration	3-204
Figure 3-117	Private VLAN Information	3-205
Figure 3-118	Private VLAN Configuration	3-206
Figure 3-119	Private VLAN Association	3-207
Figure 3-120	Private VLAN Port Information	3-208
Figure 3-121	Private VLAN Port Configuration	3-209
Figure 3-122	Protocol VLAN Configuration	3-211
Figure 3-123	Protocol VLAN System Configuration	3-212
Figure 3-124	LLDP Configuration	3-214
Figure 3-125	LLDP Port Configuration	3-217
Figure 3-126	LLDP Local Device Information	3-219
Figure 3-127	LLDP Remote Port Information	3-221
Figure 3-128	LLDP Remote Information Details	3-222
Figure 3-129	LLDP Device Statistics	3-224
Figure 3-130	LLDP Device Statistics Details	3-225
Figure 3-131	Port Priority Configuration	3-227
Figure 3-132	Traffic Classes	3-229

Figure 3-133	Queue Mode	3-230
Figure 3-134	Configuring Queue Scheduling	3-231
Figure 3-135	IP DSCP Priority Status	3-232
Figure 3-136	Mapping IP DSCP Priority Values	3-233
Figure 3-137	Configuring Class Maps	3-237
Figure 3-138	Configuring Policy Maps	3-240
Figure 3-139	Service Policy Settings	3-241
Figure 3-140	Configuring VoIP Traffic	3-243
Figure 3-141	VoIP Traffic Port Configuration	3-244
Figure 3-142	Telephony OUI List	3-246
Figure 3-143	IGMP Configuration	3-250
Figure 3-144	IGMP Immediate Leave	3-252
Figure 3-145	Displaying Multicast Router Port Information	3-253
Figure 3-146	Static Multicast Router Port Configuration	3-254
Figure 3-147	IP Multicast Registration Table	3-255
Figure 3-148	IGMP Member Port Table	3-256
Figure 3-149	Enabling IGMP Filtering and Throttling	3-257
Figure 3-150	IGMP Profile Configuration	3-259
Figure 3-151	IGMP Filter and Throttling Port Configuration	3-260
Figure 3-152	MVR Global Configuration	3-263
Figure 3-153	MVR Port Information	3-264
Figure 3-154	MVR Group IP Information	3-265
Figure 3-155	MVR Port Configuration	3-267
Figure 3-156	MVR Group Member Configuration	3-268
Figure 3-157	Cluster Member Choice	3-269
Figure 3-158	Cluster Configuration	3-270
Figure 3-159	Cluster Member Configuration	3-271
Figure 3-160	Cluster Member Information	3-272
Figure 3-161	Cluster Candidate Information	3-272
Figure 3-162	UPnP Configuration	3-274

# Chapter 1: Introduction

---

These switches provide a broad range of features for Layer 2 switching. They include a management agent that allows you to configure the features listed in this manual. The default configuration can be used for most of the features provided by these switches. However, there are many options that you should configure to maximize the switch's performance for your particular network environment.

The Fast Ethernet ports on the iES4028FP switch also support the IEEE 802.3af Power-over-Ethernet (PoE) standard that enables DC power to be supplied to attached devices over the connecting Ethernet cable.

## Key Features

**Table 1-1 Key Features**

Feature	Description
Power over Ethernet	Powers attached devices using IEEE 802.3af Power over Ethernet (PoE)
Configuration Backup and Restore	Backup to TFTP server
Authentication and Security Measures	Console, Telnet, web – User name / password, RADIUS, TACACS+ AAA – Authentication, Authorization, and Accounting Web – HTTPS Telnet – SSH SNMP v1/2c - Community strings SNMP version 3 – MD5 or SHA password Port Authentication – IEEE 802.1X, Port Security – MAC address filtering Private VLANs Network Access – MAC Address Authentication Web Authentication – Web access with RADIUS Authentication DHCP Snooping (with Option 82 relay information)
Access Control Lists	Supports IP and MAC ACLs, 100 rules per system
DHCP Client	Supported
DHCP Snooping	Supported with Option 82 relay information
Port Configuration	Speed, duplex mode and flow control
Port Trunking	Supports up to 8 trunks using either static or dynamic trunking (LACP)
Port Mirroring	One or more ports mirrored to a single analysis port
Congestion Control	Rate Limiting Throttling for broadcast storms
Static Addresses	Up to 8K MAC addresses in the forwarding table
IEEE 802.1D Bridge	Supports dynamic data switching and addresses learning
Store-and-Forward Switching	Supported to ensure wire-speed switching while eliminating bad frames

**Table 1-1 Key Features** (Continued)

Feature	Description
Spanning Tree Algorithm	Supports standard STP, Rapid Spanning Tree Protocol (RSTP), and Multiple Spanning Trees (MSTP)
Virtual LANs	Up to 255 using IEEE 802.1Q, port-based, protocol-based, private VLANs, voice VLANs, and QinQ tunnel
Traffic Prioritization	Default port priority, traffic class map, queue scheduling, or Differentiated Services Code Point (DSCP), and TCP/UDP Port
Quality of Service	Supports Differentiated Services (DiffServ)
Link Layer Discovery Protocol	Used to discover basic information about neighboring devices
Multicast Filtering	Supports IGMP snooping and query, as well as Multicast VLAN Registration
Tunneling	Supports tunneling with IEEE 802.1Q tunneling (QinQ)
Switch Clustering	Supports up to 36 Member switches in a cluster

## Description of Software Features

These switches provide a wide range of advanced performance enhancing features. Flow control eliminates the loss of packets due to bottlenecks caused by port saturation. Broadcast storm suppression prevents broadcast traffic storms from engulfing the network. Port-based, protocol-based and private VLANs, plus support for automatic GVRP VLAN registration provide traffic security and efficient use of network bandwidth. CoS priority queueing ensures the minimum delay for moving real-time multimedia data across the network. While multicast filtering provides support for real-time network applications. Some of the management features are briefly described below.

**Configuration Backup and Restore** – You can save the current configuration settings to a file on a TFTP server, and later download this file to restore the switch configuration settings.

**Authentication** – These switches authenticate management access via the console port, Telnet or web browser. User names and passwords can be configured locally or can be verified via a remote authentication server (i.e., RADIUS or TACACS+). Port-based authentication is also supported via the IEEE 802.1X protocol. This protocol uses the Extensible Authentication Protocol over LANs (EAPOL) to request user credentials from the 802.1X client, and then verifies the client’s right to access the network via an authentication server (i.e., RADIUS server).

These switches also support authentication, authorization, and accounting. AAA provides accounting and billing for IEEE 802.1X authenticated users that access the network, and for users that access management interfaces through the console and Telnet. Authorization is provided for users that access management interfaces on the switch through the console and Telnet. The AAA features use RADIUS or TACACS+ server groups for centralized and robust administration control.

Other authentication options include HTTPS for secure management access via the web, SSH for secure management access over a Telnet-equivalent connection, IP address filtering for SNMP/web/Telnet management access, and MAC address filtering for port access.

**Access Control Lists** – ACLs provide packet filtering for IP frames (based on address, protocol, or TCP/UDP port number or TCP control code) or any frames (based on MAC address or Ethernet type). ACLs can be used to improve performance by blocking unnecessary network traffic or to implement security controls by restricting access to specific network resources or protocols.

**Port Configuration** – You can manually configure the speed, duplex mode, and flow control used on specific ports, or use auto-negotiation to detect the connection settings used by the attached device. Use the full-duplex mode on ports whenever possible to double the throughput of switch connections. Flow control should also be enabled to control network traffic during periods of congestion and prevent the loss of packets when port buffer thresholds are exceeded. These switches support flow control based on the IEEE 802.3x standard.

**Port Mirroring** – These switches can unobtrusively mirror traffic from any port to a monitor port. You can then attach a protocol analyzer or RMON probe to this port to perform traffic analysis and verify connection integrity.

**Port Trunking** – Ports can be combined into an aggregate connection. Trunks can be manually set up or dynamically configured using IEEE 802.3-2005 (formerly IEEE 802.3ad) Link Aggregation Control Protocol (LACP). The additional ports dramatically increase the throughput across any connection, and provide redundancy by taking over the load if a port in the trunk should fail. These switches support up to 8 trunks.

**Rate Limiting** – This feature controls the maximum rate for traffic transmitted or received on an interface. Rate limiting is configured on interfaces at the edge of a network to limit traffic into or out of the network. Traffic that falls within the rate limit is transmitted, while packets that exceed the acceptable amount of traffic are dropped.

**Broadcast Storm Control** – Broadcast suppression prevents broadcast traffic from overwhelming the network. When enabled on a port, the level of broadcast traffic passing through the port is restricted. If broadcast traffic rises above a pre-defined threshold, it will be throttled until the level falls back beneath the threshold.

**Static Addresses** – A static address can be assigned to a specific interface on these switches. Static addresses are bound to the assigned interface and will not be moved. When a static address is seen on another interface, the address will be ignored and will not be written to the address table. Static addresses can be used to provide network security by restricting access for a known host to a specific port.

**IEEE 802.1D Bridge** – These switches support IEEE 802.1D transparent bridging. The address table facilitates data switching by learning addresses, and then filtering or forwarding traffic based on this information. The address table supports up to 8K addresses.

**Store-and-Forward Switching** – These switches copy each frame into its memory before forwarding them to another port. This ensures that all frames are a standard Ethernet size and have been verified for accuracy with the cyclic redundancy check (CRC). This prevents bad frames from entering the network and wasting bandwidth.

To avoid dropping frames on congested ports, these switches provide 1 Mbits for frame buffering. This buffer can queue packets awaiting transmission on congested networks.

**Spanning Tree Algorithm** – These switches support these spanning tree protocols:

**Spanning Tree Protocol (STP, IEEE 802.1D)** – This protocol provides loop detection and recovery by allowing two or more redundant connections to be created between a pair of LAN segments. When there are multiple physical paths between segments, this protocol will choose a single path and disable all others to ensure that only one route exists between any two stations on the network. This prevents the creation of network loops. However, if the chosen path should fail for any reason, an alternate path will be activated to maintain the connection.

**Rapid Spanning Tree Protocol (RSTP, IEEE 802.1w)** – This protocol reduces the convergence time for network topology changes to 3 to 5 seconds, compared to 30 seconds or more for the older IEEE 802.1D STP standard. It is intended as a complete replacement for STP, but can still interoperate with switches running the older standard by automatically reconfiguring ports to STP-compliant mode if they detect STP protocol messages from attached devices.

**Multiple Spanning Tree Protocol (MSTP, IEEE 802.1s)** – This protocol is a direct extension of RSTP. It can provide an independent spanning tree for different VLANs. It simplifies network management, provides for even faster convergence than RSTP by limiting the size of each region, and prevents VLAN members from being segmented from the rest of the group (as sometimes occurs with IEEE 802.1D STP).

**Virtual LANs** – These switches support up to 255 VLANs. A Virtual LAN is a collection of network nodes that share the same collision domain regardless of their physical location or connection point in the network. These switches support tagged VLANs based on the IEEE 802.1Q standard. Members of VLAN groups can be dynamically learned via GVRP, or ports can be manually assigned to a specific set of VLANs. This allows these switches to restrict traffic to the VLAN groups to which a user has been assigned. By segmenting your network into VLANs, you can:

- Eliminate broadcast storms which severely degrade performance in a flat network.
- Simplify network management for node changes/moves by remotely configuring VLAN membership for any port, rather than having to manually change the network connection.
- Provide data security by restricting all traffic to the originating VLAN.
- Use private VLANs to restrict traffic to pass only between data ports and the uplink ports, thereby isolating adjacent ports within the same VLAN, and allowing you to limit the total number of VLANs that need to be configured.
- Use protocol VLANs to restrict traffic to specified interfaces based on protocol type.



**Note:** These switches allow 255 user-manageable VLANs. One other VLAN (VLAN ID 4093) is reserved for switch clustering.

**Traffic Prioritization** – These switches prioritize each packet based on the required level of service, using four priority queues with strict priority or Weighted Round Robin Queuing. They use IEEE 802.1p and 802.1Q tags to prioritize incoming traffic based on input from the end-station application. These functions can be used to provide independent priorities for delay-sensitive data and best-effort data.

These switches also support several common methods of prioritizing layer 3/4 traffic to meet application requirements. Traffic can be prioritized based on the DSCP field in the IP frame. When these services are enabled, the priorities are mapped to a Class of Service value by these switches, and the traffic then sent to the corresponding output queue.

**Quality of Service** – Differentiated Services (DiffServ) provides policy-based management mechanisms used for prioritizing network resources to meet the requirements of specific traffic types on a per-hop basis. Each packet is classified upon entry into the network based on access lists, IP Precedence or DSCP values, or VLAN lists. Using access lists allows you select traffic based on Layer 2, Layer 3, or Layer 4 information contained in each packet. Based on network policies, different kinds of traffic can be marked for different kinds of forwarding.

**Multicast Filtering** – Specific multicast traffic can be assigned to its own VLAN to ensure that it does not interfere with normal network traffic and to guarantee real-time delivery by setting the required priority level for the designated VLAN. These switches use IGMP Snooping and Query to manage multicast group registration. They also support Multicast VLAN Registration (MVR) which allows common multicast traffic, such as television channels, to be transmitted across a single network-wide multicast VLAN shared by hosts residing in other standard or private VLAN groups, while preserving security and data isolation for normal traffic.

**Tunneling** – Configures tunnels for customer traffic crossing the service provider's network using IEEE 802.1Q.

IEEE 802.1Q Tunneling (QinQ) – This feature is designed for service providers carrying traffic for multiple customers across their networks. QinQ tunneling is used to maintain customer-specific VLANs and Layer 2 protocol configurations even when different customers use the same internal VLAN IDs. This is accomplished by inserting Service Provider VLAN (SPVLAN) tags into the customer's frames when they enter the service provider's network, and then stripping the tags when the frames leave the network.

**Link Layer Discovery Protocol** – LLDP is used to discover basic information about neighboring devices within the local broadcast domain. LLDP is a Layer 2 protocol that advertises information about the sending device and collects information gathered from neighboring network nodes it discovers.

Advertised information is represented in Type Length Value (TLV) format according to the IEEE 802.1ab standard, and can include details such as device identification, capabilities and configuration settings. Media Endpoint Discovery (LLDP-MED) is an extension of LLDP intended for managing endpoint devices such as Voice over IP phones and network switches. The LLDP-MED TLVs advertise information such as network policy, power, inventory, and device location details. The LLDP and LLDP-MED information can be used by SNMP applications to simplify troubleshooting, enhance network management, and maintain an accurate network topology.

## System Defaults

The system defaults for these switches are provided in the configuration file "Factory\_Default\_Config.cfg." To reset the switch defaults, this file should be set as the startup configuration file (page 3-23).

The following table lists some of the basic system defaults.

**Table 1-2 System Defaults**

Function	Parameter	Default
Console Port Connection	Baud Rate	9600
	Data bits	8
	Stop bits	1
	Parity	none
	Local Console Timeout	0 (disabled)
Authentication	Privileged Exec Level	Username "admin" Password "admin"
	Normal Exec Level	Username "guest" Password "guest"
	Enable Privileged Exec from Normal Exec Level	Password "super"
	RADIUS Authentication	Disabled
	TACACS Authentication	Disabled
	802.1X Port Authentication	Disabled
	MAC Address Authentication	Disabled
	Web Authentication	Disabled
	HTTPS	Enabled
	SSH	Disabled
	Port Security	Disabled
	IP Filtering	Disabled

Table 1-2 System Defaults (Continued)

Function	Parameter	Default
Web Management	HTTP Server	Enabled
	HTTP Port Number	80
	HTTP Secure Server	Enabled
	HTTP Secure Port Number	443
SNMP	SNMP Agent	Enabled
	Community Strings	"public" (read only) "private" (read/write)
	Traps	Authentication traps: enabled Link-up-down events: enabled
	SNMP V3	View: defaultview Group: public (read only); private (read/write)
Port Configuration	Admin Status	Enabled
	Auto-negotiation	Enabled
	Flow Control	Disabled
Port Trunking	Static Trunks	None
	LACP (all ports)	Disabled
Congestion Control	Rate Limiting	Disabled
	Storm Control	Enabled (all ports), 64 kbits per second
Address Table	Aging Time	300 seconds
Spanning Tree Algorithm	Status	Enabled, RSTP (Defaults: All values based on IEEE 802.1w)
	Fast Forwarding (Edge Port)	Disabled
LLDP	Status	Enabled
Virtual LANs	Default VLAN	1
	PVID	1
	Acceptable Frame Type	All
	Ingress Filtering	Enabled
	Switchport Mode (Egress Mode)	Hybrid: tagged/untagged frames
	GVRP (global)	Disabled
	GVRP (port interface)	Disabled
QinQ	Status	Disabled

**Table 1-2 System Defaults** (Continued)

<b>Function</b>	<b>Parameter</b>	<b>Default</b>
Traffic Prioritization	Ingress Port Priority	0
	Weighted Round Robin	Queue: 0 1 2 3 Weight: 1 2 4 8
	IP DSCP Priority	Disabled
IP Settings	IP Address	DHCP assigned
	Subnet Mask	255.255.255.0
	Default Gateway	0.0.0.0
	DHCP	Client: Enabled
	BOOTP	Disabled
Multicast Filtering	IGMP Snooping	Snooping: Enabled Querier: Disabled
	Multicast VLAN Registration	Disabled
System Log	Status	Enabled
	Messages Logged	Levels 0-7 (all)
	Messages Logged to Flash	Levels 0-3
SMTP Email Alerts	Event Handler	Enabled (but no server defined)
SNTP	Clock Synchronization	Disabled
NTP	Clock Synchronization	Disabled
DHCP Snooping	Status	Disabled
IP Source Guard	Status	Disabled (all ports)
Switch Clustering	Status	Enabled
	Commander	Disabled

# Chapter 2: Initial Configuration

---

## Connecting to the Switch

### Configuration Options

These switches include a built-in network management agent. The agent offers a variety of management options, including SNMP, RMON (Groups 1, 2, 3, 9) and a web-based interface. A PC may also be connected directly to the switch for configuration and monitoring via a command line interface (CLI).

**Note:** The IP address for this switch is obtained via DHCP by default. To change this address, see “Setting an IP Address” on page 2-4.

The switch’s HTTP web agent allows you to configure switch parameters, monitor port connections, and display statistics using a standard web browser such as Internet Explorer 5.x or above, Netscape 6.2 or above, and Mozilla Firefox 2.0.0.0 or above. The switch’s web management interface can be accessed from any computer attached to the network.

The CLI program can be accessed by a direct connection to the RS-232 serial console port on the switch, or remotely by a Telnet or Secure Shell (SSH) connection over the network.

The switch’s management agent also supports SNMP (Simple Network Management Protocol). This SNMP agent permits the switch to be managed from any system in the network using network management software such as HP OpenView.

The switch’s web interface, CLI configuration program, and SNMP agent allow you to perform the following management functions:

- Set user names and passwords
- Set an IP interface for a management VLAN
- Configure SNMP parameters
- Enable/disable any port
- Set the speed/duplex mode for any port
- Configure the bandwidth of any port by limiting input or output rates
- Control port access through IEEE 802.1X security or static address filtering
- Filter packets using Access Control Lists (ACLs)
- Configure up to 255 IEEE 802.1Q VLANs
- Enable GVRP automatic VLAN registration
- Configure IGMP multicast filtering
- Upload and download system firmware via TFTP
- Upload and download switch configuration files via TFTP
- Configure Spanning Tree parameters
- Configure Class of Service (CoS) priority queuing

- Configure up to 8 static or LACP trunks
- Enable port mirroring
- Set broadcast storm control on any port
- Display system information and statistics

### Required Connections

The switch provides an RS-232 serial port that enables a connection to a PC or terminal for monitoring and configuring the switch. A null-modem console cable is provided with the switch.

Attach a VT100-compatible terminal, or a PC running a terminal emulation program to the switch. You can use the console cable provided with this package, or use a null-modem cable that complies with the wiring assignments shown in the Installation Guide.

To connect a terminal to the console port, complete the following steps:

1. Connect the console cable to the serial port on a terminal, or a PC running terminal emulation software, and tighten the captive retaining screws on the DB-9 connector.
2. Connect the other end of the cable to the RS-232 serial port on the switch.
3. Make sure the terminal emulation software is set as follows:
  - Select the appropriate serial port (COM port 1 or COM port 2).
  - Set the baud rate to 9600 bps.
  - Set the data format to 8 data bits, 1 stop bit, and no parity.
  - Set flow control to none.
  - Set the emulation mode to VT100.
  - When using HyperTerminal, select Terminal keys, not Windows keys.

- Notes:**
1. Refer to “Line Commands” on page 4-40 for a complete description of console configuration options.
  2. Once you have set up the terminal correctly, the console login screen will be displayed.

For a description of how to use the CLI, see “Using the Command Line Interface” on page 4-1. For a list of all the CLI commands and detailed information on using the CLI, refer to “Command Groups” on page 4-9.

## Remote Connections

Prior to accessing the switch's onboard agent via a network connection, you must first configure it with a valid IP address, subnet mask, and default gateway using a console connection, DHCP or BOOTP protocol.

The IP address for this switch is obtained via DHCP by default. To manually configure this address or enable dynamic address assignment via DHCP or BOOTP, see "Setting an IP Address" on page 2-4.

**Note:** This switch supports four concurrent Telnet/SSH sessions.

After configuring the switch's IP parameters, you can access the onboard configuration program from anywhere within the attached network. The onboard configuration program can be accessed using Telnet from any computer attached to the network. The switch can also be managed by any computer using a web browser (Internet Explorer 5.0 or above, Netscape 6.2 or above, or Mozilla Firefox 2.0.0.0 or above), or from a network computer using SNMP network management software.

**Note:** The onboard program only provides access to basic configuration functions. To access the full range of SNMP management functions, you must use SNMP-based network management software.

## Basic Configuration

### Console Connection

The CLI program provides two different command levels — normal access level (Normal Exec) and privileged access level (Privileged Exec). The commands available at the Normal Exec level are a limited subset of those available at the Privileged Exec level and allow you to only display information and use basic utilities. To fully configure the switch parameters, you must access the CLI at the Privileged Exec level.

Access to both CLI levels are controlled by user names and passwords. The switch has a default user name and password for each level. To log into the CLI at the Privileged Exec level using the default user name and password, perform these steps:

1. To initiate your console connection, press <Enter>. The "User Access Verification" procedure starts.
2. At the Username prompt, enter "admin."
3. At the Password prompt, also enter "admin." (The password characters are not displayed on the console screen.)
4. The session is opened and the CLI displays the "Console#" prompt indicating you have access at the Privileged Exec level.

### Setting Passwords

**Note:** If this is your first time to log into the CLI program, you should define new passwords for both default user names using the “username” command, record them and put them in a safe place.

Passwords can consist of up to 8 alphanumeric characters and are case sensitive. To prevent unauthorized access to the switch, set the passwords as follows:

1. Open the console interface with the default user name and password “admin” to access the Privileged Exec level.
2. Type “configure” and press <Enter>.
3. Type “username guest password 0 *password*,” for the Normal Exec level, where *password* is your new password. Press <Enter>.
4. Type “username admin password 0 *password*,” for the Privileged Exec level, where *password* is your new password. Press <Enter>.

**Note:** ‘0’ specifies the password in plain text, ‘7’ specifies the password in encrypted form.

```
Username: admin
Password:

CLI session with the Ubigate iES4028FP* is opened.
To end the CLI session, enter [Exit].

Console#configure
Console(config)#username guest password 0 [password]
Console(config)#username admin password 0 [password]
Console(config)#
```

\* This manual covers both the Ubigate iES4028F and iES4028FP switches. Other than iES4028FP’s support for PoE, there are no other significant differences. Therefore all of the screen display examples are based on the iES4028FP.

### Setting an IP Address

You must establish IP address information for the stack to obtain management access through the network. This can be done in either of the following ways:

**Manual** — You have to input the information, including IP address and subnet mask. If your management station is not in the same IP subnet as the switch, you will also need to specify the default gateway router.

**Dynamic** — The switch sends IP configuration requests to BOOTP or DHCP address allocation servers on the network.



## Manual Configuration

You can manually assign an IP address to the switch. You may also need to specify a default gateway that resides between this device and management stations that exist on another network segment. Valid IP addresses consist of four decimal numbers, 0 to 255, separated by periods. Anything outside this format will not be accepted by the CLI program.

**Note:** The IP address for this switch is obtained via DHCP by default.

Before you can assign an IP address to the switch, you must obtain the following information from your network administrator:

- IP address for the switch
- Default gateway for the network
- Network mask for this network

To assign an IP address to the switch, complete the following steps:

1. From the Privileged Exec level global configuration mode prompt, type “interface vlan 1” to access the interface-configuration mode. Press <Enter>.
2. Type “ip address *ip-address netmask*,” where “ip-address” is the switch IP address and “netmask” is the network mask for the network. Press <Enter>.
3. Type “exit” to return to the global configuration mode prompt. Press <Enter>.
4. To set the IP address of the default gateway for the network to which the switch belongs, type “ip default-gateway *gateway*,” where “gateway” is the IP address of the default gateway. Press <Enter>.

```
Console(config)#interface vlan 1
Console(config-if)#ip address 192.168.1.5 255.255.255.0
Console(config-if)#exit
Console(config)#ip default-gateway 192.168.1.254
Console(config)#
```

## Dynamic Configuration

If you select the “bootp” or “dhcp” option, the system will immediately start broadcasting service requests. IP will be enabled but will not function until a BOOTP or DHCP reply has been received. Requests are broadcast every few minutes using exponential backoff until IP configuration information is obtained from a BOOTP or DHCP server. (BOOTP and DHCP values can include the IP address, subnet mask, and default gateway.)

Note that the “ip dhcp restart” command can also be used to start broadcasting service requests to obtain address assignments through BOOTP or DHCP. It may be necessary to use this command when DHCP is configured on a VLAN, and the member ports which were previously shut down are now enabled.

If the “bootp” or “dhcp” option is saved to the startup-config file (step 6), then the switch will start broadcasting service requests as soon as it is powered on.

## 2 Initial Configuration

To automatically configure the switch by communicating with BOOTP or DHCP address allocation servers on the network, complete the following steps:

1. From the Global Configuration mode prompt, type “interface vlan 1” to access the interface-configuration mode. Press <Enter>.
2. At the interface-configuration mode prompt, use one of the following commands:
  - To obtain IP settings via DHCP, type “ip address dhcp” and press <Enter>.
  - To obtain IP settings via BOOTP, type “ip address bootp” and press <Enter>.
3. Type “end” to return to the Privileged Exec mode. Press <Enter>.
4. Wait a few minutes, and then check the IP configuration settings by typing the “show ip interface” command. Press <Enter>.
5. Then save your configuration changes by typing “copy running-config startup-config.” Enter the startup file name and press <Enter>.

```
Console(config)#interface vlan 1
Console(config-if)#ip address dhcp
Console(config-if)#end
Console#show ip interface
  IP address and netmask: 192.168.1.54 255.255.255.0 on VLAN 1,
  and address mode: User specified.
Console#copy running-config startup-config
Startup configuration file name []: startup
\Write to FLASH Programming.

\Write to FLASH finish.
Success.
```

### Enabling SNMP Management Access

The switch can be configured to accept management commands from Simple Network Management Protocol (SNMP) applications such as HP OpenView. You can configure the switch to respond to SNMP requests or generate SNMP traps.

When SNMP management stations send requests to the switch (either to return information or to set a parameter), the switch provides the requested data or sets the specified parameter. The switch can also be configured to send information to SNMP managers (without being requested by the managers) through trap messages, which inform the manager that certain events have occurred.

The switch includes an SNMP agent that supports SNMP version 1, 2c, and 3 clients. To provide management access for version 1 or 2c clients, you must specify a community string. The switch provides a default MIB View (i.e., an SNMPv3 construct) for the default “public” community string that provides read access to the entire MIB tree, and a default view for the “private” community string that provides read/write access to the entire MIB tree. However, you may assign new views to version 1 or 2c community strings that suit your specific security requirements (see page 3-55).

## Community Strings (for SNMP version 1 and 2c clients)

Community strings are used to control management access to SNMP version 1 and 2c stations, as well as to authorize SNMP stations to receive trap messages from the switch. You therefore need to assign community strings to specified users, and set the access level.

The default strings are:

- **public** - with read-only access. Authorized management stations are only able to retrieve MIB objects.
- **private** - with read-write access. Authorized management stations are able to both retrieve and modify MIB objects.

To prevent unauthorized access to the switch from SNMP version 1 or 2c clients, it is recommended that you change the default community strings.

To configure a community string, complete the following steps:

1. From the Privileged Exec level global configuration mode prompt, type “snmp-server community *string mode*,” where “string” is the community access string and “mode” is **rw** (read/write) or **ro** (read only). Press <Enter>. (Note that the default mode is read only.)
2. To remove an existing string, simply type “no snmp-server community *string*,” where “string” is the community access string to remove. Press <Enter>.

```
Console(config)#snmp-server community admin rw          4-88
Console(config)#snmp-server community private
Console(config)#
```

**Note:** If you do not intend to support access to SNMP version 1 and 2c clients, we recommend that you delete both of the default community strings. If there are no community strings, then SNMP management access from SNMP v1 and v2c clients is disabled.

## Trap Receivers

You can also specify SNMP stations that are to receive traps from the switch. To configure a trap receiver, use the “snmp-server host” command. From the Privileged Exec level global configuration mode prompt, type:

```
“snmp-server host host-address community-string
[version {1 | 2c | 3 {auth | noauth | priv}}]”
```

where “host-address” is the IP address for the trap receiver, “community-string” specifies access rights for a version 1/2c host, or is the user name of a version 3 host, “version” indicates the SNMP client version, and “auth | noauth | priv” means that authentication, no authentication, or authentication and privacy is used for v3 clients. Then press <Enter>. For a more detailed description of these parameters,

see “snmp-server host” on page 4-90. The following example creates a trap host for each type of SNMP client.

```
Console(config)#snmp-server host 10.1.19.23 batman 4-90
Console(config)#snmp-server host 10.1.19.98 robin version 2c
Console(config)#snmp-server host 10.1.19.34 barbie version 3 auth
Console(config)#
```

### Configuring Access for SNMP Version 3 Clients

To configure management access for SNMPv3 clients, you need to first create a view that defines the portions of MIB that the client can read or write, assign the view to a group, and then assign the user to a group. The following example creates one view called “mib-2” that includes the entire MIB-2 tree branch, and then another view that includes the IEEE 802.1d bridge MIB. It assigns these respective read and read/write views to a group call “r&d” and specifies group authentication via MD5 or SHA. In the last step, it assigns a v3 user to this group, indicating that MD5 will be used for authentication, provides the password “greenpeace” for authentication, and the password “einstien” for encryption.

```
Console(config)#snmp-server view mib-2 1.3.6.1.2.1 included 4-94
Console(config)#snmp-server view 802.1d 1.3.6.1.2.1.17 included
Console(config)#snmp-server group r&d v3 auth mib-2 802.1d 4-96
Console(config)#snmp-server user steve group r&d v3 auth md5
greenpeace priv des56 einstien 4-98
Console(config)#
```

For a more detailed explanation on how to configure the switch for access from SNMP v3 clients, refer to “Simple Network Management Protocol” on page 3-40, or refer to the specific CLI commands for SNMP starting on page 4-86.

## Managing System Files

The switch’s flash memory supports three types of system files that can be managed by the CLI program, web interface, or SNMP. The switch’s file system allows files to be uploaded and downloaded, copied, deleted, and set as a start-up file.

The three types of files are:

- **Configuration** — This file type stores system configuration information and is created when configuration settings are saved. Saved configuration files can be selected as a system start-up file or can be uploaded via TFTP to a server for backup. The file named “Factory\_Default\_Config.cfg” contains all the system default settings and cannot be deleted from the system. If the system is booted with the factory default settings, the switch will also create a file named “startup1.cfg” that contains system settings for initialization, including information about the unit identifier and MAC address. The configuration settings from the factory defaults configuration file are copied to this file, which is then used to boot the switch. See “Saving or Restoring Configuration Settings” on page 3-23 for more information.

- **Operation Code** — System software that is executed after boot-up, also known as run-time or firmware code. This code runs the switch operations and provides the CLI and web management interfaces. See “Managing Firmware” on page 3-21 for more information.
- **Diagnostic Code** — Software that is run during system boot-up, also known as POST (Power On Self-Test).

Due to the size limit of the flash memory, the switch supports only one operation code file. However, you can have as many diagnostic code files and configuration files as available flash memory space allows. Transferring a new operation code file to the switch will overwrite the existing file. Versions of the code prior to 1.1.0.3 require the operation code file being transferred to have the same destination file name as the existing code file for the transfer to succeed.

In the system flash memory, one file of each type must be set as the start-up file. During a system boot, the diagnostic and operation code files set as the start-up file are run, and then the start-up configuration file is loaded.

Note that configuration files should be downloaded using a file name that reflects the contents or usage of the file settings. If you download directly to the running-config, the system will reboot, and the settings will have to be copied from the running-config to a permanent file.

## Saving Configuration Settings

Configuration commands only modify the running configuration file and are not saved when the switch is rebooted. To save all your configuration changes in nonvolatile storage, you must copy the running configuration file to the start-up configuration file using the “copy” command.

New startup configuration files must have a name specified. File names on the switch are case-sensitive, can be from 1 to 31 characters, must not contain slashes (\ or /), and the leading letter of the file name must not be a period (.). (Valid characters: A-Z, a-z, 0-9, “.”, “-”, “\_”)

There can be more than one user-defined configuration file saved in the switch’s flash memory, but only one is designated as the “startup” file that is loaded when the switch boots. The **copy running-config startup-config** command always sets the new file as the startup file. To select a previously saved configuration file, use the **boot system config:<filename>** command.

The maximum number of saved configuration files depends on available flash memory, with each configuration file normally requiring less than 20 kbytes. The amount of available flash memory can be checked by using the **dir** command.

To save the current configuration settings, enter the following command:

1. From the Privileged Exec mode prompt, type “copy running-config startup-config” and press <Enter>.
2. Enter the name of the start-up file. Press <Enter>.

```
Console#copy running-config startup-config
Startup configuration file name []: startup
\Write to FLASH Programming.

\Write to FLASH finish.
Success.

Console#
```

## Configuring Power over Ethernet

The IES4028FP switch's 24 10/100 Mbps ports support the IEEE 802.3af Power-over-Ethernet (PoE) standard that enables DC power to be supplied to attached devices over the wire pairs in the connecting Ethernet cable. Any 802.3af compliant device attached to a port can directly draw power from the switch over the Ethernet cable without requiring its own separate power source. This capability gives network administrators centralized power control for devices such as IP phones and wireless access points, which translates into greater network availability.

A maximum PoE power budget for the switch (power available to all switch ports) can be defined so that power can be centrally managed, preventing overload conditions at the power source. If the power demand from devices connected to the switch exceeds the power budget setting, the switch uses port power priority settings to limit the supplied power.

In the example below, the **power mainpower maximum allocation** CLI command is used to set the PoE power budget for the switch. (Range: 37 - 375 watts). If devices connected to the switch require more power than the switch budget, the port power priority settings are used to control the supplied power. See “Setting a Switch Power Budget” on page 3-155 for details.

```
Console(config)#power mainpower maximum allocation 180      4-213
Console(config)#
```

PoE is enabled for all ports by default. Power can be disabled for a port by using the **no** form of the **power inline** CLI command, as shown in the example below.

```
Console(config)#interface ethernet 1/2                      4-187
Console(config-if)#no power inline                          4-214
Console(config-if)#
```

# Chapter 3: Configuring the Switch

---

## Using the Web Interface

These switches provide an embedded HTTP web agent. Using a web browser you can configure the switch and view statistics to monitor network activity. The web agent can be accessed by any computer on the network using a standard web browser (Internet Explorer 5.0 or above, Netscape 6.2 or above, or Mozilla Firefox 2.0.0.0 or above).

**Note:** You can also use the Command Line Interface (CLI) to manage the switch over a serial connection to the console port or via Telnet. For more information on using the CLI, refer to Chapter 4: "Command Line Interface."

Prior to accessing the switch from a web browser, be sure you have first performed the following tasks:

1. Configure the switch with a valid IP address, subnet mask, and default gateway using an out-of-band serial connection, BOOTP or DHCP protocol. (See "Setting an IP Address" on page 2-4.)
2. Set user names and passwords using an out-of-band serial connection. Access to the web agent is controlled by the same user names and passwords as the onboard configuration program. (See "Setting Passwords" on page 2-4)
3. After you enter a user name and password, you will have access to the system configuration program.

- Notes:**
1. You are allowed three attempts to enter the correct password; on the third failed attempt the current connection is terminated.
  2. If you log into the web interface as guest (Normal Exec level), you can view the configuration settings or change the guest password. If you log in as "admin" (Privileged Exec level), you can change the settings on any page.
  3. If the path between your management station and this switch does not pass through any device that uses the Spanning Tree Algorithm, then you can set the switch port attached to your management station to fast forwarding (i.e., enable Admin Edge Port) to improve the switch's response time to management commands issued through the web interface. See "Configuring Interface Settings" on page 3-174.

### 3 Configuring the Switch

## Navigating the Web Browser Interface

To access the web-browser interface you must first enter a user name and password. The administrator has Read/Write access to all configuration parameters and statistics. The default user name and password for the administrator is “admin.”

### Home Page

When your web browser connects with the switch’s web agent, the home page is displayed as shown below. The home page displays the Main Menu on the left side of the screen and System Information on the right side. The Main Menu links are used to navigate to other menus, and display configuration parameters and statistics.

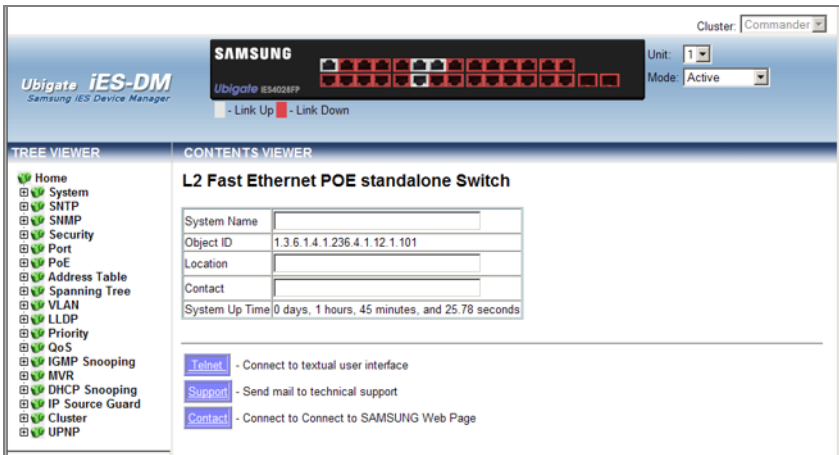

Figure 3-1 Home Page

**Note:** The examples in this chapter are based on the Ubigate iES4028FP. Other than iES4028FP’s support for PoE, there are no other significant differences between the iES4028F and iES4028FP. The panel graphics for both switch types are shown on the following page.



## Configuration Options

Configurable parameters have a dialog box or a drop-down list. Once a configuration change has been made on a page, be sure to click on the Apply button to confirm the new setting. The following table summarizes the web page configuration buttons.

**Table 3-1 Configuration Options**

Button	Action
Revert	Cancels specified values and restores current values prior to pressing Apply.
Apply	Sets specified values to the system.
Help	Links directly to webhelp.

- Notes:**
- To ensure proper screen refresh, be sure that Internet Explorer is configured so that the setting "Check for newer versions of stored pages" reads "Every visit to the page".  
Internet Explorer 6.x and earlier: This option is available under the menu "Tools / Internet Options / General / Temporary Internet Files / Settings".  
Internet Explorer 7.x: This option is available under "Tools / Internet Options / General / Browsing History / Settings / Temporary Internet Files".
  - You may have to manually refresh the screen after making configuration changes by pressing the browser's refresh button.

## Panel Display

The web agent displays an image of the switch's ports. The Mode can be set to display different information for the ports, including Active (i.e., up or down), Duplex (i.e., half or full duplex, or Flow Control (i.e., with or without flow control). Clicking on the image of a port opens the Port Configuration page as described on page 3-129.

### iES4028F



### iES4028FP



**Figure 3-2 Panel Display**

## Main Menu

Using the onboard web agent, you can define system parameters, manage and control the switch, and all its ports, or monitor network conditions. The following table briefly describes the selections available from this program.

**Table 3-2 Main Menu**

Menu	Description	Page
System		3-12
System Information	Provides basic system description, including contact information	3-12
Switch Information	Shows the number of ports, hardware/firmware version numbers, and power status	3-14
Bridge Extension Configuration	Shows the bridge extension parameters	3-16
IP Configuration	Sets the IP address for management access	3-17
Jumbo Frames	Enables jumbo frame packets.	3-20
File Management		3-21
Copy Operation	Allows the transfer and copying of files	3-21
Delete	Allows deletion of files from the flash memory	3-22
Set Start-Up	Sets the startup file	3-22
Line		3-25
Console	Sets console port connection parameters	3-25
Telnet	Sets Telnet connection parameters	3-27
Log		3-29
Logs	Stores and displays error messages	3-29
System Logs	Sends error messages to a logging process	3-29
Remote Logs	Configures the logging of messages to a remote logging process	3-30
SMTP	Sends an SMTP client message to a participating server.	3-32
Reset	Restarts the switch	3-34
SNTP		3-35
Configuration	Configures SNTP and NTP client settings, including broadcast mode, authentication parameters or a specified list of servers	3-36
Clock Time Zone	Sets the local time zone for the system clock	3-39
SNMP		3-40
Configuration	Configures community strings and related trap functions	3-42
Agent Status	Enables or disables SNMP Agent Status	3-41

Table 3-2 Main Menu (Continued)

Menu	Description	Page
SNMPv3		3-46
Engine ID	Sets the SNMP v3 engine ID on this switch	3-46
Remote Engine ID	Sets the SNMP v3 engine ID for a remote device	3-47
Users	Configures SNMP v3 users on this switch	3-48
Remote Users	Configures SNMP v3 users from a remote device	3-50
Groups	Configures SNMP v3 groups	3-52
Views	Configures SNMP v3 views	3-55
Security		3-57
User Accounts	Assigns a new password for the current user	3-58
Authentication Settings	Configures authentication sequence, RADIUS and TACACS	3-59
Encryption Key	Configures RADIUS and TACACS encryption key settings	3-64
AAA		3-65
RADIUS Group Settings	Defines the configured RADIUS servers to use for accounting	3-66
TACACS+ Group Settings	Defines the configured TACACS+ servers to use for accounting	3-67
Accounting		
Settings	Configures accounting of requested services for billing or security purposes	3-67
Periodic Update	Sets the interval at which accounting updates are sent to RADIUS AAA servers	3-69
802.1X Port Settings	Applies the specified accounting method to an interface	3-70
Command Privileges	Specifies a method name to apply to commands entered at specific CLI privilege levels	3-71
Exec Settings	Specifies console or Telnet authentication method	3-72
Summary	Displays accounting information and statistics	3-72
Authorization		3-74
Settings	Configures authorization of requested services	3-74
EXEC Settings	Specifies console or Telnet authorization method	3-75
Summary	Displays authorization information	3-76
HTTPS Settings	Configures secure HTTP settings	3-64
SSH		3-79
Settings	Configures Secure Shell server settings	3-97
Host-Key Settings	Generates the host key pair (public and private)	3-82
SSH User Public-Key Settings	Imports and manages user RSA and DSA public keys	3-84

**Table 3-2 Main Menu (Continued)**

Menu	Description	Page
Port Security	Configures per port security, including status, response for security breach, and maximum allowed MAC addresses	3-97
802.1X		3-88
Information	Displays global configuration settings for 802.1X Port authentication	3-90
Configuration	Configures the global configuration settings	3-90
Port Configuration	Sets parameters for individual ports	3-90
Statistics	Displays protocol statistics for the selected port	3-93
Web Authentication		3-98
Configuration	Configures Web Authentication settings	3-99
Port Configuration	Enables Web Authentication for individual ports	3-100
Port Information	Displays status information for individual ports	3-101
Re-authentication	Forces a host to re-authenticate itself immediately	3-101
Network Access		3-102
Configuration	Configures global Network Access parameters	3-103
Port Configuration	Configures Network Access parameters for individual ports	3-104
MAC Address Information	Displays Network Access statistics sorted by various attributes	3-106
MAC Authentication		3-107
Port Configuration	Configures MAC Authentication parameters for ports	3-107
ACL		3-108
Configuration	Configures packet filtering based on IP or MAC addresses	3-108
Port Binding	Binds a port to the specified ACL	3-115
IP Filter	Sets IP addresses of clients allowed management access via the web, SNMP, and Telnet	3-94
Port		3-127
Port Information	Displays port connection status	3-127
Trunk Information	Displays trunk connection status	3-127
Port Configuration	Configures port connection settings	3-129
Trunk Configuration	Configures trunk connection settings	3-129
Trunk Membership	Specifies ports to group into static trunks	3-133
LACP		3-134
Configuration	Allows ports to dynamically join trunks	3-134
Aggregation Port	Configures parameters for link aggregation group members	3-136
Aggregation Group	Configures the administration key for specific LACP groups	3-139

Table 3-2 Main Menu (Continued)

Menu	Description	Page
Port Counters Information	Displays statistics for LACP protocol messages	3-140
Port Internal Information	Displays settings and operational state for the local side	3-141
Port Neighbors Information	Displays settings and operational state for the remote side	3-143
Port Broadcast Control	Sets the broadcast storm threshold for each port	3-145
Trunk Broadcast Control	Sets the broadcast storm threshold for each trunk	3-145
Mirror Port Configuration	Sets the source and target ports for mirroring	3-147
Rate Limit		3-148
Input Port Configuration	Sets the input rate limit for each port	3-148
Input Trunk Configuration	Sets the input rate limit for each trunk	3-148
Output Port Configuration	Sets the output rate limit for ports	3-148
Output Trunk Configuration	Sets the output rate limit for trunks	3-148
Port Statistics	Lists Ethernet and RMON port statistics	3-149
PoE		3-153
Power Status	Displays the status of global power parameters	3-154
Power Configuration	Configures the power budget for the switch	3-155
Power Port Status	Displays the status of port power parameters	3-155
Power Port Configuration	Configures port power parameters	3-156
Address Table		3-158
Static Addresses	Displays entries for interface, address or VLAN	3-158
Dynamic Addresses	Displays or edits static entries in the Address Table	3-159
Address Aging	Sets timeout for dynamically learned entries	3-160
Spanning Tree		3-161
Port Loopback Detection	Configures Port Loopback Detection parameters	3-163
Trunk Loopback Detection	Configures Trunk Loopback Detection parameters	3-163
STA		3-161
Information	Displays STA values used for the bridge	3-164
Configuration	Configures global bridge settings for STA and RSTP	3-167
Port Information	Displays individual port settings for STA	3-171
Trunk Information	Displays individual trunk settings for STA	3-171
Port Configuration	Configures individual port settings for STA	3-174
Trunk Configuration	Configures individual trunk settings for STA	3-174

**Table 3-2 Main Menu (Continued)**

Menu	Description	Page
MSTP		3-177
VLAN Configuration	Configures priority and VLANs for a spanning tree instance	3-177
Port Information	Displays port settings for a specified MST instance	3-180
Trunk Information	Displays trunk settings for a specified MST instance	3-180
Port Configuration	Configures port settings for a specified MST instance	3-182
Trunk Configuration	Configures trunk settings for a specified MST instance	3-182
VLAN		3-183
802.1Q VLAN		3-183
GVRP Status	Enables GVRP on the switch	3-186
802.1Q Tunnel Configuration	Enables 802.1Q (QinQ) Tunneling	3-200
Basic Information	Displays information on the VLAN type supported by this switch	3-187
Current Table	Shows the current port members of each VLAN and whether or not the port is tagged or untagged	3-188
Static List	Used to create or remove VLAN groups	3-189
Static Table	Modifies the settings for an existing VLAN	3-191
Static Membership by Port	Configures membership type for interfaces, including tagged, untagged or forbidden	3-193
Port Configuration	Specifies default PVID and VLAN attributes	3-194
Trunk Configuration	Specifies default trunk VID and VLAN attributes	3-194
Tunnel Port Configuration	Adds an interface to a QinQ Tunnel	3-201
Tunnel Trunk Configuration	Adds an interface to a QinQ Tunnel	3-201
Traffic Segmentation	Configures traffic segmentation for different client sessions based on specified downlink and uplink ports	3-202
Status	Enables traffic segmentation, and blocks or forwards traffic between uplink ports assigned to different client sessions	3-202
Session Configuration	Creates a client session, and assigns the downlink and uplink ports to service the traffic	3-203
Private VLAN		3-204
Information	Displays Private VLAN feature information	3-205
Configuration	This page is used to create/remove primary or community VLANs	3-206
Association	Each community VLAN must be associated with a primary VLAN	3-207
Port Information	Shows VLAN port type, and associated primary or secondary VLANs	3-207

Table 3-2 Main Menu (Continued)

Menu	Description	Page
Port Configuration	Sets the private VLAN interface type, and associates the interfaces with a private VLAN	3-208
Trunk Information	Shows VLAN port type, and associated primary or secondary VLANs	3-207
Trunk Configuration	Sets the private VLAN interface type, and associates the interfaces with a private VLAN	3-208
Protocol VLAN		3-210
Configuration	Configures protocol VLANs	3-210
System Configuration	Configures protocol VLAN system parameters	3-211
LLDP		3-212
Configuration	Configures global LLDP timing parameters	3-213
Port Configuration	Configures parameters for individual ports	3-215
Trunk Configuration	Configures parameters for trunks	3-215
Local Information	Displays LLDP information about the local device	3-218
Remote Port Information	Displays LLDP information about a remote device connected to a port on this switch	3-220
Remote Trunk Information	Displays LLDP information about a remote device connected to a trunk on this switch	3-220
Remote Information Details	Displays detailed LLDP information about a remote device connected to this switch	3-221
Device Statistics	Displays LLDP statistics for all connected remote devices	3-223
Device Statistics Details	Displays LLDP statistics for remote devices on a selected port or trunk	3-225
Priority		3-226
Default Port Priority	Sets the default priority for each port	3-226
Default Trunk Priority	Sets the default priority for each trunk	3-226
Traffic Classes	Maps IEEE 802.1p priority tags to output queues	3-228
Traffic Classes Status	Enables/disables traffic class priorities (not implemented)	N/A
Queue Mode	Sets queue mode to strict priority or Weighted Round-Robin	3-230
Queue Scheduling	Configures Weighted Round Robin queueing	3-230
IP DSCP Priority Status	Globally selects DSCP Priority, or disables it.	3-232
IP DSCP Priority	Sets IP Differentiated Services Code Point priority, mapping a DSCP tag to a class-of-service value	3-233

**Table 3-2 Main Menu (Continued)**

Menu	Description	Page
QoS		3-234
DiffServ		3-234
Class Map	Sets Class Maps	3-235
Policy Map	Sets Policy Maps	3-238
Service Policy	Defines service policy settings for ports	3-241
VoIP Traffic Setting		3-242
Configuration	VoIP Traffic Setting Configuration	3-242
Port Configuration	Configures VoIP Traffic Settings for ports	3-243
OUI Configuration	Defines OUI settings	3-245
IGMP Snooping		3-248
IGMP Configuration	Enables multicast filtering; configures parameters for multicast query	3-249
IGMP Filter Configuration	Configures IGMP filtering	3-249
IGMP Immediate Leave	Enables the immediate leave function	3-251
Multicast Router Port Information	Displays the ports that are attached to a neighboring multicast router for each VLAN ID	3-252
Static Multicast Router Port Configuration	Assigns ports that are attached to a neighboring multicast router	3-253
IP Multicast Registration Table	Displays all multicast groups active on this switch, including multicast IP addresses and VLAN ID	3-254
IGMP Member Port Table	Indicates multicast addresses associated with the selected VLAN	3-255
IGMP Filter Profile Configuration	Configures IGMP Filter Profiles	3-258
IGMP Filter/Throttling Port Configuration	Configures IGMP Filtering and Throttling for ports	3-259
IGMP Filter/Throttling Trunk Configuration	Configures IGMP Filtering and Throttling for trunks	3-259
MVR		3-261
Configuration	Globally enables MVR, sets the MVR VLAN, adds multicast stream addresses	3-262
Port Information	Displays MVR interface type, MVR operational and activity status, and immediate leave status	3-264
Trunk Information	Displays MVR interface type, MVR operational and activity status, and immediate leave status	3-264
Group IP Information	Displays the ports attached to an MVR multicast stream	3-265
Port Configuration	Configures MVR interface type and immediate leave status	3-266



**Table 3-2 Main Menu** (Continued)

<b>Menu</b>	<b>Description</b>	<b>Page</b>
Trunk Configuration	Configures MVR interface type and immediate leave status	3-266
Group Member Configuration	Statically assigns MVR multicast streams to an interface	3-267
DHCP Snooping		3-116
Configuration	Enables DHCP Snooping and DHCP Snooping MAC-Address Verification	3-117
VLAN Configuration	Enables DHCP Snooping for a VLAN	3-118
Information Option Configuration	Enables DHCP Snooping Information Option	3-118
Port Configuration	Selects the DHCP Snooping Information Option policy	3-120
Binding Information	Displays the DHCP Snooping binding information	3-122
IP Source Guard		3-123
Port Configuration	Enables IP source guard and selects filter type per port	3-123
Static Configuration	Adds a static addresses to the source-guard binding table	3-124
Dynamic Information	Displays the source-guard binding table for a selected interface	3-126
Cluster		3-269
Configuration	Globally enables clustering for the switch	3-269
Member Configuration	Adds switch Members to the cluster	3-270
Member Information	Displays cluster Member switch information	3-271
Candidate Information	Displays network Candidate switch information	3-272
UPNP		3-273
Configuration	Enables UPNP and defines timeout values	3-274

# Basic Configuration

This section describes the basic functions required to set up management access to the switch, display or upgrade operating software, or reset the system.

## Displaying System Information

You can easily identify the system by displaying the device name, location and contact information.

### Field Attributes

- **System Name** – Name assigned to the switch system.
- **Object ID** – MIB II object ID for switch's network management subsystem.
- **Location** – Specifies the system location.
- **Contact** – Administrator responsible for the system.
- **System Up Time** – Length of time the management agent has been up.

These additional parameters are displayed for the CLI.

- **MAC Address** – The physical layer address for this switch.
- **Web Server** – Shows if management access via HTTP is enabled.
- **Web Server Port** – Shows the TCP port number used by the web interface.
- **Web Secure Server** – Shows if management access via HTTPS is enabled.
- **Web Secure Server Port** – Shows the TCP port used by the HTTPS interface.
- **Telnet Server** – Shows if management access via Telnet is enabled.
- **Telnet Server Port** – Shows the TCP port used by the Telnet interface.
- **Jumbo Frame** – Shows if jumbo frames are enabled.
- **POST Result** – Shows results of the power-on self-test.

**Web** – Click System, System Information. Specify the system name, location, and contact information for the system administrator, then click Apply. (This page also includes a Telnet button that allows access to the Command Line Interface via Telnet.)

### L2 Fast Ethernet POE standalone Switch

System Name	<input type="text"/>
Object ID	1.3.6.1.4.1.236.4.1.12.1.101
Location	<input type="text"/>
Contact	<input type="text"/>
System Up Time	0 days, 2 hours, 26 minutes, and 7.87 seconds

---

[Telnet](#) - Connect to textual user interface

[Support](#) - Send mail to technical support

[Contact](#) - Connect to Connect to SAMSUNG Web Page

**Figure 3-3 System Information**

**CLI** – Specify the hostname, location and contact information.

```

Console(config)#hostname R&D 5                               4-17
Console(config)#snmp-server location WC 9                   4-89
Console(config)#snmp-server contact Ted                     4-88
Console(config)#exit
Console#show system                                         4-31
System Description: L2 Fast Ethernet POE standalone Switch
System OID String: 1.3.6.1.4.1.236.4.1.12.1.101*
System Information
  System Up Time:           0 days, 2 hours, 26 minutes, and 30.55 seconds
  System Name:              R&D 5
  System Location:         WC 9
  System Contact:          Ted
  MAC Address (Unit1):    00-16-B6-F0-71-3C
  Web Server:              Enabled
  Web Server Port:        80
  Web Secure Server:      Enabled
  Web Secure Server Port: 443
  Telnet Server:          Enable
  Telnet Server Port:     23
  Jumbo Frame:            Disabled

  POST result
DUMMY Test 1 ..... PASS
UART Loopback Test ..... PASS
POE UART Loopback Test ..... PASS
DRAM Test ..... PASS
Timer Test ..... PASS

Done All Pass.
Console#

```

\* The iES4028F and iES4028FP MIB Object Identifiers are 1.3.6.1.4.1.236.4.1.12.1.102 and 1.3.6.1.4.1.236.4.1.12.1.101 respectively.

## Displaying Switch Hardware/Software Versions

Use the Switch Information page to display hardware/firmware version numbers for the main board and management software, as well as the power status of the system.

### Field Attributes

#### Main Board

- **Serial Number** – The serial number of the switch.
- **Number of Ports** – Number of built-in RJ-45 ports.
- **Hardware Version** – Hardware version of the main board.
- **Internal Power Status** – Displays the status of the internal power supply.

#### Management Software

- **EPLD Version** – Version number of the Electronically Programmable Logic Device code.
- **Loader Version** – Version number of loader code.
- **Boot-ROM Version** – Version of Power-On Self-Test (POST) and boot code.
- **Operation Code Version** – Version number of runtime code.
- **Role** – Shows that this switch is operating as Master or Slave.

**Web** – Click System, Switch Information.

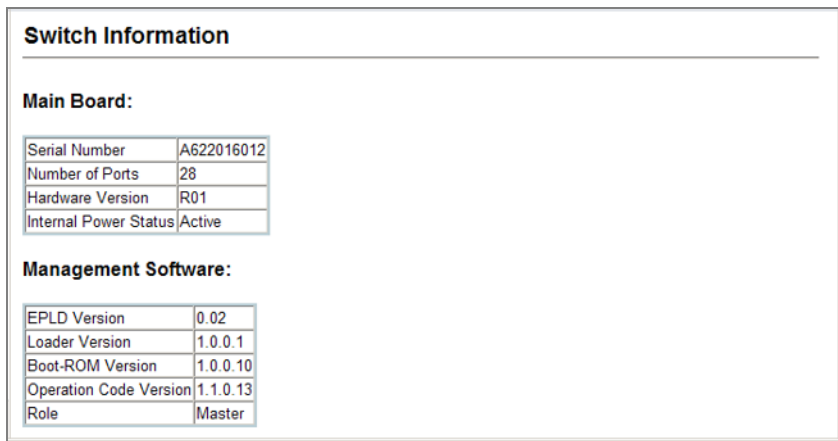

The screenshot displays the 'Switch Information' page. It is divided into two main sections: 'Main Board' and 'Management Software'. Each section contains a table of attributes and their values.

Switch Information	
<b>Main Board:</b>	
Serial Number	A622016012
Number of Ports	28
Hardware Version	R01
Internal Power Status	Active
<b>Management Software:</b>	
EPLD Version	0.02
Loader Version	1.0.0.1
Boot-ROM Version	1.0.0.10
Operation Code Version	1.1.0.13
Role	Master

Figure 3-4 Switch Information

**CLI** – Use the following command to display version information.

```
Console#show version
Unit 1
Serial Number:          A622016012
Hardware Version:      R01
EPLD Version:          0.02
Number of Ports:       28
Main Power Status:     Up
Redundant Power Status: Not present

Agent (Master)
Unit ID:                1
Loader Version:         1.0.0.1
Boot ROM Version:       1.0.0.10
Operation Code Version: 1.1.0.13

Console#
```

4-32

## Displaying Bridge Extension Capabilities

The Bridge MIB includes extensions for managed devices that support Multicast Filtering, Traffic Classes, and Virtual LANs. You can access these extensions to display default settings for the key variables.

### Field Attributes

- **Extended Multicast Filtering Services** – This switch does not support the filtering of individual multicast addresses based on GMRP (GARP Multicast Registration Protocol).
- **Traffic Classes** – This switch provides mapping of user priorities to multiple traffic classes. (Refer to “Class of Service Configuration” on page 3-226.)
- **Static Entry Individual Port** – This switch allows static filtering for unicast and multicast addresses. (Refer to “Setting Static Addresses” on page 3-158.)
- **VLAN Learning** – This switch uses Independent VLAN Learning (IVL), where each port maintains its own filtering database.
- **Configurable PVID Tagging** – This switch allows you to override the default Port VLAN ID (PVID used in frame tags) and egress status (VLAN-Tagged or Untagged) on each port. (Refer to “VLAN Configuration” on page 3-183.)
- **Local VLAN Capable** – This switch does not support multiple local bridges outside of the scope of 802.1Q defined VLANs.
- **GMRP** – GARP Multicast Registration Protocol (GMRP) allows network devices to register endstations with multicast groups. This switch does not support GMRP; it uses the Internet Group Management Protocol (IGMP) to provide automatic multicast filtering.

**Web** – Click System, Bridge Extension Configuration.

### Bridge Extension Configuration

---

#### Bridge Capability

Extended Multicast Filtering Services	No
Traffic Classes	Enabled
Static Entry Individual Port	Yes
VLAN Learning	IVL
Configurable PVID Tagging	Yes
Local VLAN Capable	No

---

GMRP  Enabled

Figure 3-5 Bridge Extension Configuration

**CLI** – Enter the following command.

```
Console#show bridge-ext 4-249
Max support VLAN numbers:      256
Max support VLAN ID:          4094
Extended multicast filtering services: No
Static entry individual port:  Yes
VLAN learning:                 IVL
Configurable PVID tagging:    Yes
Local VLAN capable:           No
Traffic classes:               Enabled
Global GVRP status:           Disabled
GMRP:                          Disabled
Console#
```

## Setting the Switch's IP Address

This section describes how to configure an IP interface for management access over the network. The IP address for the stack is obtained via DHCP by default. To manually configure an address, you need to change the switch's default settings to values that are compatible with your network. You may also need to establish a default gateway between the switch and management stations that exist on another network segment.

You can manually configure a specific IP address, or direct the device to obtain an address from a BOOTP or DHCP server. Valid IP addresses consist of four decimal numbers, 0 to 255, separated by periods. Anything outside this format will not be accepted by the CLI program.

### Command Attributes

- **Management VLAN** – ID of the configured VLAN (1-4094). By default, all ports on the switch are members of VLAN 1. However, the management station can be attached to a port belonging to any VLAN, as long as that VLAN has been assigned an IP address.
- **IP Address Mode** – Specifies whether IP functionality is enabled via manual configuration (Static), Dynamic Host Configuration Protocol (DHCP), or Boot Protocol (BOOTP). If DHCP/BOOTP is enabled, IP will not function until a reply has been received from the server. Requests will be broadcast periodically by the switch for an IP address. (DHCP/BOOTP values can include the IP address, subnet mask, and default gateway.)
- **IP Address** – Address of the VLAN interface that is allowed management access. Valid IP addresses consist of four numbers, 0 to 255, separated by periods. (Default: 0.0.0.0)
- **Subnet Mask** – This mask identifies the host address bits used for routing to specific subnets. (Default: 255.0.0.0)
- **Gateway IP address** – IP address of the gateway router between this device and management stations that exist on other network segments. (Default: 0.0.0.0)
- **MAC Address** – The physical layer address for this switch.
- **Restart DHCP** – Requests a new IP address from the DHCP server.

### 3 Configuring the Switch

#### Manual Configuration

**Web** – Click System, IP Configuration. Select the VLAN through which the management station is attached, set the IP Address Mode to “Static,” enter the IP address, subnet mask and gateway, then click Apply.

#### IP Configuration

Management VLAN	1
IP Address Mode	Static
IP Address	192.168.1.254
Subnet Mask	255.255.255.0
Gateway IP Address	0.0.0.0
MAC Address	00-16-B6-F0-71-3C

Figure 3-6 Manual IP Configuration

**CLI** – Specify the management interface, IP address and default gateway.

```
Console#config
Console(config)#interface vlan 1                               4-187
Console(config-if)#ip address 192.168.1.254 255.255.255.0    4-345
Console(config-if)#exit
Console(config)#ip default-gateway 0.0.0.0                    4-346
Console(config)#
```



## Using DHCP/BOOTP

If your network provides DHCP/BOOTP services, you can configure the switch to be dynamically configured by these services.

**Web** – Click System, IP Configuration. Specify the VLAN to which the management station is attached, set the IP Address Mode to DHCP or BOOTP. Click Apply to save your changes. Then click Restart DHCP to immediately request a new address. Note that the switch will also broadcast a request for IP configuration settings on each power reset.

### IP Configuration

---

Management VLAN	1
IP Address Mode	DHCP
IP Address	192.168.1.254
Subnet Mask	255.255.255.0
Gateway IP Address	0.0.0.0
MAC Address	00-16-B6-F0-71-3C

Figure 3-7 DHCP IP Configuration

**Note:** If you lose your management connection, use a console connection and enter “show ip interface” to determine the new switch address.

**CLI** – Specify the management interface, and set the IP address mode to DHCP or BOOTP, and then enter the “ip dhcp restart” command.

```

Console#config
Console(config)#interface vlan 1                               4-187
Console(config-if)#ip address dhcp                             4-345
Console(config-if)#end
Console#ip dhcp restart                                       4-347
Console#show ip interface                                     4-347
  IP address and netmask: 192.168.1.254 255.255.255.0 on VLAN 1,
  and address mode:      User specified.
Console#

```

**Renewing DCHP** – DHCP may lease addresses to clients indefinitely or for a specific period of time. If the address expires or the switch is moved to another network segment, you will lose management access to the switch. In this case, you can reboot the switch or submit a client request to restart DHCP service via the CLI.

### 3 Configuring the Switch

**Web** – If the address assigned by DHCP is no longer functioning, you will not be able to renew the IP settings via the web interface. You can only restart DHCP service via the web interface if the current address is still available.

**CLI** – Enter the following command to restart DHCP service.

```
Console#ip dhcp restart  
Console#
```

4-347

## Enabling Jumbo Frames

The switch provides more efficient throughput for large sequential data transfers by supporting jumbo frames up to 10 KB for the Gigabit Ethernet ports. Compared to standard Ethernet frames that run only up to 1.5 KB, using jumbo frames significantly reduces the per-packet overhead required to process protocol encapsulation fields.

### Command Usage

To use jumbo frames, both the source and destination end nodes (such as a computer or server) must support this feature. Also, when the connection is operating at full duplex, all switches in the network between the two end nodes must be able to accept the extended frame size. And for half-duplex connections, all devices in the collision domain would need to support jumbo frames.

### Command Attributes

**Jumbo Packet Status** – Check the box to enable jumbo frames.

**Web** – Click System, Jumbo Frames.



**Jumbo Frames**

---

Jumbo Packet Status  Enabled

Figure 3-8 Jumbo Frames Configuration

**CLI** – Enter the following command.

```
Console(config)#jumbo frame  
Console(config)#
```

4-33

## Managing Firmware

You can upload/download firmware to or from a TFTP server. Just specify the method of file transfer, along with the file type and file names as required. By saving runtime code to a file on a TFTP server, that file can later be downloaded to the switch to restore operation.

Only one copy of the system software (i.e., the runtime firmware) can be stored in the file directory on the switch. When downloading runtime code, the new firmware file will therefore overwrite the existing file.

### Command Attributes

- **File Transfer Method** – The firmware copy operation includes these options:
  - file to file – Copies a file within the switch directory, assigning it a new name.
  - file to tftp – Copies a file from the switch to a TFTP server.
  - tftp to file – Copies a file from a TFTP server to the switch.
- **TFTP Server IP Address** – The IP address of a TFTP server.
- **File Type** – Specify opcode (operational code) to copy firmware.
- **File Name** – The file name should not contain slashes (\ or /), the leading letter of the file name should not be a period (.), and the maximum length for file names on the TFTP server is 127 characters or 31 characters for files on the switch. (Valid characters: A-Z, a-z, 0-9, ".", "-", "\_")

**Note:** Transferring a new operation code file to the switch will overwrite the existing file. Versions of the code prior to 1.1.0.10 require the operation code file being transferred to have the same destination file name as the existing code file for the transfer to succeed.

### 3 Configuring the Switch

#### Downloading System Software from a Server

When downloading runtime code, the new operation code file will overwrite the existing file. Versions of the code prior to 1.1.0.10 require the operation code file being transferred to have the same destination file name as the existing code file for the transfer to succeed.

**Web** –Click System, File Management, Copy Operation. Select “tftp to file” as the file transfer method, enter the IP address of the TFTP server, set the file type to “opcode,” enter the file name of the software to download, select a file on the switch to overwrite or specify a new file name, then click Apply. If you replaced the current firmware used for startup and want to start using the new operation code, reboot the system via the System/Reset menu.

Copy	
file to file	▼
File Type	opcode ▼
Source File Name	runtime.bix ▼
Destination File Name	<input type="radio"/> runtime.bix ▼
	<input checked="" type="radio"/> runtime1.bix

Figure 3-9 Copy Firmware

The new file is automatically set as the startup code since the switch only supports the presence of one firmware file. After the transfer is complete, restart the system for the new code to take effect.

To delete a file, select System, File, Delete. Select the file name from the given list by checking the tick box and click Apply. Note that the file currently designated as the startup code cannot be deleted.

	Name	Type	Startup	Size (bytes)
<input checked="" type="checkbox"/>	Factory_Default_Config.cfg	Config_File	N	455
<input type="checkbox"/>	startup1.cfg	Config_File	Y	3376
<input type="checkbox"/>	runtime.bix	Operation_Code	Y	3927304

Figure 3-10 Deleting Files

**CLI** – To download new firmware from a TFTP server, enter the IP address of the TFTP server, select “opcode” as the file type, then enter the source and destination file names. When the file has finished downloading, and then restart the switch for the new code to take effect.

To start the new firmware, enter the “reload” command or reboot the system.

```

Console#copy tftp file                                     4-35
TFTP server ip address: 192.168.1.23
Choose file type:
 1. config:  2. opcode:  4. diag:  5. loader: <1,2,4,5>: 2
Source file name: runtime.bix
Destination file name: runtime1.bix
\Write to FLASH Programming.
-Write to FLASH finish.
Success.
Console#config
Console(config)#boot system opcode:runtime1.bix         4-39
Console(config)#exit
Console#reload                                           4-13

```

## Saving or Restoring Configuration Settings

You can upload/download configuration settings to/from a TFTP server. The configuration files can be later downloaded to restore the switch’s settings.

### Command Attributes

- **File Transfer Method** – The configuration copy operation includes these options:
  - file to file – Copies a file within the switch directory, assigning it a new name.
  - file to running-config – Copies a file in the switch to the running configuration.
  - file to startup-config – Copies a file in the switch to the startup configuration.
  - file to tftp – Copies a file from the switch to a TFTP server.
  - running-config to file – Copies the running configuration to a file.
  - running-config to startup-config – Copies the running config to the startup config.
  - running-config to tftp – Copies the running configuration to a TFTP server.
  - startup-config to file – Copies the startup configuration to a file on the switch.
  - startup-config to running-config – Copies the startup config to the running config.
  - startup-config to tftp – Copies the startup configuration to a TFTP server.
  - tftp to file – Copies a file from a TFTP server to the switch.
  - tftp to running-config – Copies a file from a TFTP server to the running config.
  - tftp to startup-config – Copies a file from a TFTP server to the startup config.
- **TFTP Server IP Address** – The IP address of a TFTP server.
- **File Type** – Specify config (configuration) to copy configuration settings.
- **File Name** — The file name should not contain slashes (\ or /), the leading letter of the file name should not be a period (.), and the maximum length for file names on the TFTP server is 127 characters or 31 characters for files on the switch. (Valid characters: A-Z, a-z, 0-9, “.”, “-”, “\_”)

**Note:** The maximum number of user-defined configuration files is limited only by available flash memory space.

### 3 Configuring the Switch

#### Downloading Configuration Settings from a Server

You can download the configuration file under a new file name and then set it as the startup file, or you can specify the current startup configuration file as the destination file to directly replace it. Note that the file “Factory\_Default\_Config.cfg” can be copied to the TFTP server, but cannot be used as the destination on the switch.

**Web** – Click System, File Management, Copy Operation. Select “tftp to startup-config” or “tftp to file” and enter the IP address of the TFTP server. Specify the name of the file to download and select a file on the switch to overwrite or specify a new file name, then click Apply.

Copy	
tftp to startup-config	
TFTP Server IP Address	192.168.1.23
Source File Name	config-startup
Startup File Name	<input type="radio"/> Factory_Default_Config.cfg <input checked="" type="radio"/> startup

Figure 3-11 Downloading Configuration Settings for Startup

If you download to a new file name using “tftp to startup-config” or “tftp to file,” the file is automatically set as the start-up configuration file. To use the new settings, reboot the system via the System/Reset menu.

**Note:** You can also select any configuration file as the start-up configuration by using the System/File/Set Start-Up page.

Set Start-Up				
	Name	Type	Startup	Size(bytes)
<input type="radio"/>	Factory_Default_Config.cfg	Config_File	N	5197
<input checked="" type="radio"/>	startup	Config_File	Y	5571
<input checked="" type="radio"/>	V2271.F	Operation_Code	Y	1761944

Figure 3-12 Setting the Startup Configuration Settings

**CLI** – Enter the IP address of the TFTP server, specify the source file on the server, set the startup file name on the switch, and then restart the switch.

```
Console#copy tftp startup-config 4-35
TFTP server ip address: 192.168.1.19
Source configuration file name: config-1
Startup configuration file name [] : startup
\Write to FLASH Programming.
-Write to FLASH finish.
Success.
Console#reload
```

To select another configuration file as the start-up configuration, use the **boot system** command and then restart the switch.

```
Console#config
Console(config)#boot system config: startup-new 4-39
Console(config)#exit
Console#reload 4-13
```

## Console Port Settings

You can access the onboard configuration program by attaching a VT100 compatible device to the switch's serial console port. Management access through the console port is controlled by various parameters, including a password, timeouts, and basic communication settings. These parameters can be configured via the web or CLI interface.

### Command Attributes

- **Login Timeout** – Sets the interval that the system waits for a user to log into the CLI. If a login attempt is not detected within the timeout interval, the connection is terminated for the session. (Range: 0-300 seconds; Default: 0 seconds)
- **Exec Timeout** – Sets the interval that the system waits until user input is detected. If user input is not detected within the timeout interval, the current session is terminated. (Range: 0-65535 seconds; Default: 600 seconds)
- **Password Threshold** – Sets the password intrusion threshold, which limits the number of failed logon attempts. When the logon attempt threshold is reached, the system interface becomes silent for a specified amount of time (set by the Silent Time parameter) before allowing the next logon attempt. (Range: 0-120; Default: 3 attempts)
- **Silent Time** – Sets the amount of time the management console is inaccessible after the number of unsuccessful logon attempts has been exceeded. (Range: 0-65535; Default: 0)
- **Data Bits** – Sets the number of data bits per character that are interpreted and generated by the console port. If parity is being generated, specify 7 data bits per character. If no parity is required, specify 8 data bits per character. (Default: 8 bits)
- **Parity** – Defines the generation of a parity bit. Communication protocols provided by some terminals can require a specific parity bit setting. Specify Even, Odd, or None. (Default: None)

### 3 Configuring the Switch

- **Speed** – Sets the terminal line's baud rate for transmit (to terminal) and receive (from terminal). Set the speed to match the baud rate of the device connected to the serial port. (Range: 9600, 19200, or 38400 baud; Default: 9600 baud)
- **Stop Bits** – Sets the number of the stop bits transmitted per byte. (Range: 1-2; Default: 1 stop bit)
- **Password<sup>1</sup>** – Specifies a password for the line connection. When a connection is started on a line with password protection, the system prompts for the password. If you enter the correct password, the system shows a prompt. (Default: No password)
- **Login<sup>1</sup>** – Enables password checking at login. You can select authentication by a single global password as configured for the Password parameter, or by passwords set up for specific user-name accounts. (Default: Local)

**Web** – Click System, Line, Console. Specify the console port connection parameters as required, then click Apply.

Console	
Login Timeout (0-300)	<input type="text" value="0"/> secs (0 : Disabled)
Exec Timeout (0-65535)	<input type="text" value="600"/> secs (0 : Disabled)
Password Threshold (0-120)	<input type="text" value="3"/> (0 : Disabled)
Silent Time (0-65535)	<input type="text" value="0"/> secs (0 : Disabled)
Data Bits	<input type="text" value="8"/>
Parity	<input type="text" value="None"/>
Speed	<input type="text" value="9600"/>
Stop Bits	<input type="text" value="1"/>

Figure 3-13 Console Port Settings

---

1. CLI only.



**CLI** – Enter Line Configuration mode for the console, then specify the connection parameters as required. To display the current console port settings, use the **show line** command from the Normal Exec level.

```

Console(config)#line console                                4-41
Console(config-line)#login local                          4-41
Console(config-line)#password 0 secret                    4-42
Console(config-line)#timeout login response 0            4-43
Console(config-line)#exec-timeout 0                      4-44
Console(config-line)#password-thresh 3                   4-44
Console(config-line)#silent-time 60                     4-45
Console(config-line)#databits 8                         4-46
Console(config-line)#parity none                        4-46
Console(config-line)#speed 19200                       4-47
Console(config-line)#stopbits 1                        4-47
Console(config-line)#end
Console#show line console                                4-48
Console configuration:
  Password threshold: 3 times
  Interactive timeout: Disabled
  Login timeout:      Disabled
  Silent time:        60
  Baudrate:           19200
  Databits:           8
  Parity:              none
  Stopbits:           1
Console#

```

## Telnet Settings

You can access the onboard configuration program over the network using Telnet (i.e., a virtual terminal). Management access via Telnet can be enabled/disabled and other various parameters set, including the TCP port number, timeouts, and a password. These parameters can be configured via the web or CLI interface.

### Command Attributes

- **Telnet Status** – Enables or disables Telnet access to the switch.  
(Default: Enabled)
- **Telnet Port Number** – Sets the TCP port number for Telnet on the switch.  
(Default: 23)
- **Login Timeout** – Sets the interval that the system waits for a user to log into the CLI. If a login attempt is not detected within the timeout interval, the connection is terminated for the session. (Range: 0-300 seconds; Default: 300 seconds)
- **Exec Timeout** – Sets the interval that the system waits until user input is detected. If user input is not detected within the timeout interval, the current session is terminated. (Range: 0-65535 seconds; Default: 600 seconds)
- **Password Threshold** – Sets the password intrusion threshold, which limits the number of failed logon attempts. When the logon attempt threshold is reached, the system interface becomes silent for a specified amount of time (set by the Silent Time parameter) before allowing the next logon attempt.  
(Range: 0-120; Default: 3 attempts)

### 3 Configuring the Switch

- **Password<sup>2</sup>** – Specifies a password for the line connection. When a connection is started on a line with password protection, the system prompts for the password. If you enter the correct password, the system shows a prompt. (Default: No password)
- **Login<sup>2</sup>** – Enables password checking at login. You can select authentication by a single global password as configured for the Password parameter, or by passwords set up for specific user-name accounts. (Default: Local)

**Web** – Click System, Line, Telnet. Specify the connection parameters for Telnet access, then click Apply.

Telnet	
Telnet Status	<input checked="" type="checkbox"/> Enabled
Telnet Port Number	<input type="text" value="23"/>
Login Timeout (0-300)	<input type="text" value="300"/> secs
Exec Timeout (0-65535)	<input type="text" value="600"/> secs
Password Threshold (0-120)	<input type="text" value="3"/> (0 : Disabled)

Figure 3-14 Enabling Telnet

**CLI** – Enter Line Configuration mode for a virtual terminal, then specify the connection parameters as required. To display the current virtual terminal settings, use the **show line** command from the Normal Exec level.

```
Console(config)#line vty 4-41
Console(config-line)#login local 4-41
Console(config-line)#password 0 secret 4-42
Console(config-line)#timeout login response 300 4-43
Console(config-line)#exec-timeout 600 4-44
Console(config-line)#password-thresh 3 4-44
Console(config-line)#end
Console#show line vty 4-48
VTY configuration:
 Password threshold: 3 times
 Interactive timeout: 600 sec
 Login timeout: 300 sec
Console#
```

---

2. CLI only.

## Configuring Event Logging

The switch allows you to control the logging of error messages, including the type of events that are recorded in switch memory, logging to a remote System Log (syslog) server, and displays a list of recent event messages.

### System Log Configuration

The system allows you to enable or disable event logging, and specify which levels are logged to RAM or flash memory.

Severe error messages that are logged to flash memory are permanently stored in the switch to assist in troubleshooting network problems. Up to 4096 log entries can be stored in the flash memory, with the oldest entries being overwritten first when the available log memory (256 kilobytes) has been exceeded.

The System Logs page allows you to configure and limit system messages that are logged to flash or RAM memory. The default is for event levels 0 to 3 to be logged to flash and levels 0 to 7 to be logged to RAM.

### Command Attributes

- **System Log Status** – Enables/disables the logging of debug or error messages to the logging process. (Default: Enabled)
- **Flash Level** – Limits log messages saved to the switch's permanent flash memory for all levels up to the specified level. For example, if level 3 is specified, all messages from level 0 to level 3 will be logged to flash. (Range: 0-7, Default: 3)

Table 3-3 Logging Levels

Level	Severity Name	Description
7	Debug	Debugging messages
6	Informational	Informational messages only
5	Notice	Normal but significant condition, such as cold start
4	Warning	Warning conditions (e.g., return false, unexpected return)
3	Error	Error conditions (e.g., invalid input, default used)
2	Critical	Critical conditions (e.g., memory allocation, or free memory error - resource exhausted)
1	Alert	Immediate action needed
0	Emergency	System unusable

\* There are only Level 2, 5, 6 and 7 error messages for the current firmware release.

- **RAM Level** – Limits log messages saved to the switch's temporary RAM memory for all levels up to the specified level. For example, if level 7 is specified, all messages from level 0 to level 7 will be logged to RAM. (Range: 0-7, Default: 7)

**Note:** The Flash Level must be equal to or less than the RAM Level.

### 3 Configuring the Switch

**Web** – Click System, Log, System Logs. Specify System Log Status, set the level of event messages to be logged to RAM and flash memory, then click Apply.

#### System Logs

---

System Log Status	<input checked="" type="checkbox"/> Enabled
Flash Level (0-7)	<input type="text" value="0"/>
Ram Level (0-7)	<input type="text" value="0"/>

Figure 3-15 System Logs

**CLI** – Enable system logging and then specify the level of messages to be logged to RAM and flash memory. Use the **show logging** command to display the current settings.

```
Console(config)#logging on 4-49
Console(config)#logging history ram 0 4-50
Console(config)#end
Console#show logging flash 4-53
Syslog logging: Enabled
History logging in FLASH: level emergencies
Console#
```

### Remote Log Configuration

The Remote Logs page allows you to configure the logging of messages that are sent to syslog servers or other management stations. You can also limit the event messages sent to only those messages below a specified level.

#### Command Attributes

- **Remote Log Status** – Enables/disables the logging of debug or error messages to the remote logging process. (Default: Enabled)
- **Logging Facility** – Sets the facility type for remote logging of syslog messages. There are eight facility types specified by values of 16 to 23. The facility type is used by the syslog server to dispatch log messages to an appropriate service. The attribute specifies the facility type tag sent in syslog messages. (See RFC 3164.) This type has no effect on the kind of messages reported by the switch. However, it may be used by the syslog server to process messages, such as sorting or storing messages in the corresponding database. (Range: 16-23, Default: 23)
- **Logging Trap** – Limits log messages that are sent to the remote syslog server for all levels up to the specified level. For example, if level 3 is specified, all messages from level 0 to level 3 will be sent to the remote server. (Range: 0-7, Default: 7)
- **Host IP List** – Displays the list of remote server IP addresses that receive the syslog messages. The maximum number of host IP addresses allowed is five.
- **Host IP Address** – Specifies a new server IP address to add to the Host IP List.

**Web** – Click System, Log, Remote Logs. To add an IP address to the Host IP List, type the new IP address in the Host IP Address box, and then click Add. To delete an IP address, click the entry in the Host IP List, and then click Remove.

### Remote Logs

---

Remote Log Status	<input checked="" type="checkbox"/> Enabled
Logging Facility (16-23)	<input type="text" value="23"/>
Logging Trap (0-7)	<input type="text" value="7"/>

---

**Host IP Address:**

Current:                      New:

Host IP List

(none)

Host IP Address

**Figure 3-16 Remote Logs**

**CLI** – Enter the syslog server host IP address, choose the facility type and set the logging trap.

```

Console(config)#logging host 192.168.1.15           4-51
Console(config)#logging facility 23                4-51
Console(config)#logging trap 4                     4-52
Console(config)#end
Console#show logging trap                           4-52
Syslog logging:                                     Enabled
REMOTELOG status:                                  Enabled
REMOTELOG facility type:                           local use 7
REMOTELOG level type:                               Warning conditions
REMOTELOG server ip address: 192.168.1.15
REMOTELOG server ip address: 0.0.0.0
REMOTELOG server ip address: 0.0.0.0
REMOTELOG server ip address: 0.0.0.0
REMOTELOG server ip address: 0.0.0.0
Console#
  
```

## 3 Configuring the Switch

### Displaying Log Messages

The Logs page allows you to scroll through the logged system and event messages. The switch can store up to 2048 log entries in temporary random access memory (RAM; i.e., memory flushed on power reset) and up to 4096 entries in permanent flash memory.

**Web** – Click System, Log, Logs.

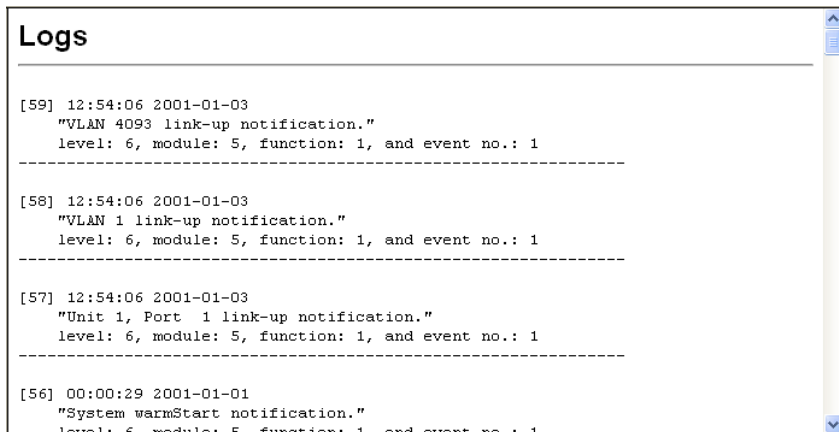
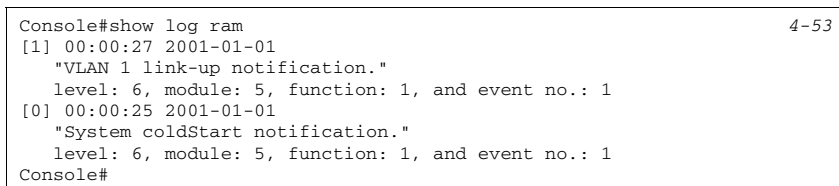

Figure 3-17 Displaying Logs

**CLI** – This example shows the event messages stored in RAM.



### Sending Simple Mail Transfer Protocol Alerts

To alert system administrators of problems, the switch can use SMTP (Simple Mail Transfer Protocol) to send email messages when triggered by logging events of a specified level. The messages are sent to specified SMTP servers on the network and can be retrieved using POP or IMAP clients.

#### Command Attributes

- **Admin Status** – Enables/disables the SMTP function. (Default: Enabled)
- **Email Source Address** – Sets the email address used for the “From” field in alert messages. You may use a symbolic email address that identifies the switch, or the address of an administrator responsible for the switch.
- **Severity** – Sets the syslog severity threshold level (see table on page 3-29) used to trigger alert messages. All events at this level or higher will be sent to the

configured email recipients. For example, using Level 7 will report all events from level 7 to level 0. (Default: Level 7)

- **SMTP Server List** – Specifies a list of up to three recipient SMTP servers. The switch attempts to connect to the other listed servers if the first fails. Use the New SMTP Server text field and the Add/Remove buttons to configure the list.
- **SMTP Server** – Specifies a new SMTP server address to add to the SMTP Server List.
- **Email Destination Address List** – Specifies the email recipients of alert messages. You can specify up to five recipients. Use the New Email Destination Address text field and the Add/Remove buttons to configure the list.
- **Email Destination Address** – This command specifies SMTP servers that may receive alert messages.

**Web** – Click System, Log, SMTP. To add an IP address to the Server IP List, type the new IP address in the Server IP Address box, and then click Add. To delete an IP address, click the entry in the Server IP List, and then click Remove.

### SMTP

---

Admin Status	<input checked="" type="checkbox"/> Enabled
Email Source Address	<input type="text"/>
Severity	7 - Debugging <input type="button" value="v"/>

---

SMTP Server List: New:

(none)	<input type="button" value="Add"/>	SMTP Server	<input type="text"/>
	<input type="button" value="Remove"/>		

---

Email Destination Address List: New:

(none)	<input type="button" value="Add"/>	Email Destination Address	<input type="text"/>
	<input type="button" value="Remove"/>		

Figure 3-18 Enabling and Configuring SMTP

### 3 Configuring the Switch

**CLI** – Enter the host ip address, followed by the mail severity level, source and destination email addresses and enter the sendmail command to complete the action. Use the show logging command to display SMTP information.

```
Console(config)#logging sendmail host 192.168.1.4           4-56
Console(config)#logging sendmail level 3                   4-57
Console(config)#logging sendmail source-email
    big-wheels@matel.com                                   4-57
Console(config)#logging sendmail destination-email
    chris@matel.com                                       4-58
Console(config)#logging sendmail                           4-58
Console(config)#exit
Console#show logging sendmail                               4-58
SMTP servers
-----
  1. 192.168.1.4

SMTP minimum severity level: 4

SMTP destination email addresses
-----
  1. chris@matel.com

SMTP source email address: big-wheels@matel.com

SMTP status:                               Enabled
Console#
```

## Resetting the System

This feature restarts the system. You can reboot the system immediately, or you can configure the switch to reset after a specified amount of time.

### Command Attributes

- **Hours** – Specifies the amount of hours to wait, combined with the minutes, before the switch resets. (Range: 0-576; Default: 0)
- **Minutes** – Specifies the amount of minutes to wait, combined with the hours, before the switch resets. (Range: 1-34560; Default: 0)
- **Reset** – Resets the switch after the specified time. If the hour and minute fields are blank, then the switch will reset immediately.
- **Refresh** – Refreshes the countdown timer of a pending delayed reset.
- **Cancel** – Cancels a pending delayed reset.



**Web** – Click System, Reset. Enter the amount of time the switch should wait before rebooting. Click the Reset button to reboot the switch or click the Cancel button to cancel a configured reset. If prompted, confirm that you want reset the switch or cancel a configured reset.

### Reset Settings

---

Note: The specified time must be equal to or less than 24 days.

Reload switch in  hours  minutes.

---

The switch will be rebooted at Jan 1 05:44:14 2001.  
 Remaining Time : 0 days, 5 hours, 0 minutes, 0 seconds.

**Figure 3-19 Resetting the System**

**CLI** – Use the **reload** command to restart the switch. When prompted, confirm that you want to reset the switch.

```

Console#reload in hour 5 minute 0
                                        4-13

The switch will be rebooted at Jan  1 05:46:36 2001.
Remaining Time : 0 days, 5 hours, 0 minutes, 0 seconds.
  
```

**Note:** When restarting the system, it will always run the Power-On Self-Test. It will also retain all configuration information stored in non-volatile memory (see “Saving or Restoring Configuration Settings” on page 3-23) or the **copy running-config startup-config** command (see “copy” on page 4-35).

## Setting the System Clock

Simple Network Time Protocol (SNTP) allows the switch to set its internal clock based on periodic updates from a time server (SNTP or NTP). Maintaining an accurate time on the switch enables the system log to record meaningful dates and times for event entries. You can also set the clock manually as described in the following section. If the clock is not set, the switch will only record the time from the factory default set at the last bootup.

When the SNTP client is enabled, the switch periodically sends a request for a time update to a configured time server. You can configure up to three time server IP addresses. The switch will attempt to poll each server in the configured sequence.

### 3 Configuring the Switch

#### Setting the Time Manually

You can set the system time on the switch manually without using SNTP.

**CLI** – This example sets the system clock time and then displays the current time and date

```
Console#calendar set 17 46 00 october 18 2008 4-72
Console#show calendar 4-72
17:46:11 October 18 2008
Console#
```

#### Configuring SNTP

You can configure the switch to send time synchronization requests to time servers.

##### Command Attributes

- **SNTP Client** – Configures the switch to operate as an SNTP client. This requires at least one time server to be specified in the SNTP Server field. (Default: Disabled)
- **SNTP Poll Interval** – Sets the interval between sending requests for a time update from a time server. (Range: 16-16384 seconds; Default: 16 seconds)
- **SNTP Server** – Sets the IP address for up to three time servers. The switch attempts to update the time from the first server, if this fails it attempts an update from the next server in the sequence.

**Web** – Select SNTP, Configuration. Modify any of the required SNTP parameters, and click Apply.

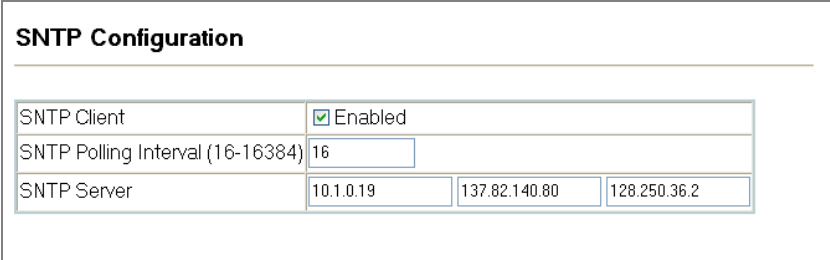

The screenshot shows the 'SNTP Configuration' web page. It features a title bar 'SNTP Configuration' and a table of configuration options. The 'SNTP Client' checkbox is checked and labeled 'Enabled'. The 'SNTP Polling Interval (16-16384)' is set to '16'. The 'SNTP Server' field contains three IP addresses: '10.1.0.19', '137.82.140.80', and '128.250.36.2'.

SNTP Configuration			
SNTP Client	<input checked="" type="checkbox"/> Enabled		
SNTP Polling Interval (16-16384)	16		
SNTP Server	10.1.0.19	137.82.140.80	128.250.36.2

Figure 3-20 SNTP Configuration

**CLI** – This example configures the switch to operate as an SNTP unicast client and then displays the current time and settings.

```
Console(config)#sntp server 10.1.0.19 137.82.140.80 128.250.36.2 4-61
Console(config)#sntp poll 60 4-61
Console(config)#sntp client 4-60
Console(config)#exit
Console#show sntp
Current time: Jan 6 14:56:05 2004
Poll interval: 60
Current mode: unicast
SNTP status : Enabled
SNTP server 10.1.0.19 137.82.140.80 128.250.36.2
Current server: 128.250.36.2
Console#
```

## Configuring NTP

The NTP client allows you to configure up to 50 NTP servers to poll for time updates. You can also enable authentication to ensure that reliable updates are received from only authorized NTP servers. The authentication keys and their associated key number must be centrally managed and manually distributed to NTP servers and clients. The key numbers and key values must match on both the server and client.

### Command Attributes

- **NTP Client** – Configures the switch to operate as an NTP client. This requires at least one time server to be specified in the NTP Server list. (Default: Disabled)
- **NTP Polling Interval** – Sets the interval between sending requests for a time update from NTP servers. (Range: 16-16384 seconds; Default: 16 seconds)
- **NTP Authenticate** – Enables authentication for time requests and updates between the switch and NTP servers. (Default: Disabled)
- **NTP Server** – Sets the IP address for an NTP server to be polled. The switch requests an update from all configured servers, then determines the most accurate time update from the responses received.
- **Version** – Specifies the NTP version supported by the server. (Range: 1-3; Default: 3)
- **Authenticate Key** – Specifies the number of the key in the NTP Authentication Key List to use for authentication with the configured server. The authentication key must match the key configured on the NTP server.
- **Key Number** – A number that specifies a key value in the NTP Authentication Key List. Up to 255 keys can be configured in the NTP Authentication Key List. Note that key numbers and values must match on both the server and client. (Range: 1-65535)
- **Key Context** – Specifies an MD5 authentication key string. The key string can be up to 32 case-sensitive printable ASCII characters (no spaces).

### 3 Configuring the Switch

**Web** – Select **SNTP, Configuration**. Modify any of the required NTP parameters, and click **Apply**.

NTP Configuration

NTP Client	<input checked="" type="checkbox"/> Enabled
NTP Polling Interval (16-16384)	16
NTP Authenticate	<input checked="" type="checkbox"/> Enabled

NTP Server List

10.1.2.19 3 9  
128.250.36.2 2 1  
137.182.140.80 3 23  
192.168.1.19 3 23

<< Add Remove

New:

NTP Server	
Version <1-3>	
Authenticate Key	

NTP Authentication Key List

1 6P71O17S56P177N5152O34S5  
9 CL1414259572U81Q1618  
23 42M141428U677Q17

<< Add Remove

New:

Key Number	
Key Context	

Figure 3-21 NTP Client Configuration

**CLI** – This example configures the switch to operate as an NTP client and then displays the current settings.

```
Console(config)#ntp authentication-key 19 md5 thisiskey19 4-65
Console(config)#ntp authentication-key 30 md5 ntpkey30
Console(config)#ntp server 192.168.3.20 4-63
Console(config)#ntp server 192.168.3.21
Console(config)#ntp server 192.168.4.22 version 2
Console(config)#ntp server 192.168.5.23 version 3 key 19
Console(config)#ntp poll 60 4-64
Console(config)#ntp client 4-62
Console(config)#ntp authenticate 4-64
Console(config)#exit
Console#show ntp 4-66
Current time: Jan 1 02:58:58 2001
Poll interval: 60
Current mode: unicast
NTP status : Enabled NTP Authenticate status : Enabled
Last Update NTP Server: 0.0.0.0 Port: 0
Last Update time: Dec 31 00:00:00 2000 UTC
NTP Server 192.168.3.20 version 3
NTP Server 192.168.3.21 version 3
NTP Server 192.168.4.22 version 2
NTP Server 192.168.5.23 version 3 key 19
NTP Authentication-Key 19 md5 Q33016Q6338241J022S29Q731K7 7
NTP Authentication-Key 30 md5 D2V8777I51K1132K3552L26R614104 7
Console#
```

## Setting the Time Zone

SNTP uses Coordinated Universal Time (or UTC, formerly Greenwich Mean Time, or GMT) based on the time at the Earth's prime meridian, zero degrees longitude, which passes through Greenwich, England. To display a time corresponding to your local time, you must indicate the number of hours and minutes your time zone is east (before) or west (after) of UTC. You can choose one of the 80 predefined time zone definitions, or you can manually configure the parameters for your local time zone.

### Command Attributes

- **Predefined Configuration** – A drop-down box provides access to the 80 predefined time zone configurations. Each choice indicates its offset from UTC and lists at least one major city or location covered by the time zone.
- **User-defined Configuration** – Allows the user to define all parameters of the local time zone.
  - **Direction:** Configures the time zone to be before (east) or after (west) UTC.
  - **Name** – Assigns a name to the time zone. (Range: 1-29 characters)
  - **Hours (0-13)** – The number of hours before/after UTC. The maximum value before UTC is 12. The maximum value after UTC is 13.
  - **Minutes (0-59)** – The number of minutes before/after UTC.

**Web** – Select SNTP, Clock Time Zone. Set the offset for your time zone relative to the UTC using either a predefined or custom definition, and click Apply.

### Time Zone

---

Predefined Configuration

Time Zone:

User-defined Configuration

Note: The maximum value before UTC is 12:00.  
The maximum value after UTC is 13:00.

Direction	<input type="radio"/> Before UTC	<input checked="" type="radio"/> After UTC
Name	<input type="text" value="UTC"/>	
Hours (0-13)	<input type="text" value="0"/>	
Minutes (0-59)	<input type="text" value="0"/>	

Figure 3-22 Setting the System Clock

**CLI** - This example shows how to set the time zone for the system clock using one of the predefined time zone configurations.

```
Console(config)#clock timezone-predefined GMT-0930-Taiohae      4-67
Console(config)#
```

## Simple Network Management Protocol

SNMP is a communication protocol designed specifically for managing devices on a network. Equipment commonly managed with SNMP includes switches, routers and host computers. SNMP is typically used to configure these devices for proper operation in a network environment, as well as to monitor them to evaluate performance or detect potential problems.

Managed devices supporting SNMP contain software, which runs locally on the device and is referred to as an agent. A defined set of variables, known as managed objects, is maintained by the SNMP agent and used to manage the device. These objects are defined in a Management Information Base (MIB) that provides a standard presentation of the information controlled by the agent. SNMP defines both the format of the MIB specifications and the protocol used to access this information over the network.

The switch includes an onboard agent that supports SNMP versions 1, 2c, and 3. This agent continuously monitors the status of the switch hardware, as well as the traffic passing through its ports. A network management station can access this information using software such as HP OpenView. Access to the onboard agent from clients using SNMP v1 and v2c is controlled by community strings. To communicate with the switch, the management station must first submit a valid community string for authentication.

Access to the switch using from clients using SNMPv3 provides additional security features that cover message integrity, authentication, and encryption; as well as controlling user access to specific areas of the MIB tree.

The SNMPv3 security structure consists of security models, with each model having it's own security levels. There are three security models defined, SNMPv1, SNMPv2c, and SNMPv3. Users are assigned to "groups" that are defined by a security model and specified security levels. Each group also has a defined security access to set of MIB objects for reading and writing, which are known as "views." The switch has a default view (all MIB objects) and default groups defined for security models v1 and v2c. The following table shows the security models and levels available and the system default settings.

Table 3-4 SNMPv3 Security Models and Levels

Model	Level	Group	Read View	Write View	Notify View	Security
v1	noAuthNoPriv	public (read only)	defaultview	none	none	Community string only
v1	noAuthNoPriv	private (read/write)	defaultview	defaultview	none	Community string only
v1	noAuthNoPriv	<i>user defined</i>	<i>user defined</i>	<i>user defined</i>	<i>user defined</i>	Community string only
v2c	noAuthNoPriv	public (read only)	defaultview	none	none	Community string only
v2c	noAuthNoPriv	private (read/write)	defaultview	defaultview	none	Community string only
v2c	noAuthNoPriv	<i>user defined</i>	<i>user defined</i>	<i>user defined</i>	<i>user defined</i>	Community string only
v3	noAuthNoPriv	<i>user defined</i>	<i>user defined</i>	<i>user defined</i>	<i>user defined</i>	A user name match only
v3	AuthNoPriv	<i>user defined</i>	<i>user defined</i>	<i>user defined</i>	<i>user defined</i>	Provides user authentication via MD5 or SHA algorithms
v3	AuthPriv	<i>user defined</i>	<i>user defined</i>	<i>user defined</i>	<i>user defined</i>	Provides user authentication via MD5 or SHA algorithms and data privacy using DES 56-bit encryption

**Note:** The predefined default groups and view can be deleted from the system. You can then define customized groups and views for the SNMP clients that require access.

## Enabling SNMP Agent Status

Enables SNMPv3 service for all management clients (i.e., versions 1, 2c, 3).

### Command Attributes

**SNMP Agent Status** – Check the box to enable or disable the SNMP Agent.

**Web** – Click SNMP, Agent Status.

### SNMP Agent Status

---

Snmp Agent Status  Enabled

Figure 3-23 Enabling SNMP Agent Status

**CLI** – The following example enables SNMP on the switch.

```
Console (config) #snmp-server
Console (config) #
```

4-86

## Setting Community Access Strings

You may configure up to five community strings authorized for management access by clients using SNMP v1 and v2c. All community strings used for IP Trap Managers should be listed in this table. For security reasons, you should consider removing the default strings.

### Command Attributes

- **SNMP Community Capability** – The switch supports up to five community strings.
- **Community String** – A community string that acts like a password and permits access to the SNMP protocol.  
Default strings: “public” (read-only), “private” (read/write)  
Range: 1-32 characters, case sensitive
- **Access Mode** – Specifies the access rights for the community string:
  - **Read-Only** – Authorized management stations are only able to retrieve MIB objects.
  - **Read/Write** – Authorized management stations are able to both retrieve and modify MIB objects.

**Web** – Click SNMP, Configuration. Add new community strings as required, select the access rights from the Access Mode drop-down list, then click Add.



Figure 3-24 Configuring SNMP Community Strings

**CLI** – The following example adds the string “spiderman” with read/write access.

```
Console(config)#snmp-server community spiderman rw          4-88
Console(config)#
```



## Specifying Trap Managers and Trap Types

Traps indicating status changes are issued by the switch to specified trap managers. You must specify trap managers so that key events are reported by this switch to your management station (using network management platforms such as HP OpenView). You can specify up to five management stations that will receive authentication failure messages and other trap messages from the switch.

### Command Usage

- If you specify an SNMP Version 3 host, then the “Trap Manager Community String” is interpreted as an SNMP user name. If you use V3 authentication or encryption options (authNoPriv or authPriv), the user name must first be defined in the SNMPv3 Users page (page 3-48). Otherwise, the authentication password and/or privacy password will not exist, and the switch will not authorize SNMP access for the host. However, if you specify a V3 host with the no authentication (noAuth) option, an SNMP user account will be automatically generated, and the switch will authorize SNMP access for the host.
- Notifications are issued by the switch as trap messages by default. The recipient of a trap message does not send a response to the switch. Traps are therefore not as reliable as inform messages, which include a request for acknowledgement of receipt. Informs can be used to ensure that critical information is received by the host. However, note that informs consume more system resources because they must be kept in memory until a response is received. Informs also add to network traffic. You should consider these effects when deciding whether to issue notifications as traps or informs.

To send an inform to a SNMPv2c host, complete these steps:

1. Enable the SNMP agent (page 3-41).
2. Enable trap informs as described in the following pages.
3. Create a view with the required notification messages (page 3-55).
4. Create a group that includes the required notify view (page 3-52).

To send an inform to a SNMPv3 host, complete these steps:

1. Enable the SNMP agent (page 3-41).
2. Enable trap informs as described in the following pages.
3. Create a view with the required notification messages (page 3-55).
4. Create a group that includes the required notify view (page 3-52).
5. Specify a remote engine ID where the user resides (page 3-47).
6. Then configure a remote user (page 3-50).

### Command Attributes

- **Trap Manager Capability** – This switch supports up to five trap managers.
- **Current** – Displays a list of the trap managers currently configured.
- **Trap Manager IP Address** – IP address of a new management station to receive notification message (i.e., the targeted recipient).
- **Trap Manager Community String** – Specifies a valid community string for the new trap manager entry. Though you can set this string in the Trap Managers table, we recommend that you define this string in the SNMP Configuration page (for

### 3 Configuring the Switch

Version 1 or 2c clients), or define a corresponding “User Name” in the SNMPv3 Users page (for Version 3 clients). (Range: 1-32 characters, case sensitive)

- **Trap UDP Port** – Specifies the UDP port number used by the trap manager. (Default: 162)
- **Trap Version** – Specifies whether to send notifications as SNMP v1, v2c, or v3 traps. (Default: v1)
- **Trap Security Level** – When trap version 3 is selected, you must specify one of the following security levels. (Default: noAuthNoPriv)
  - **noAuthNoPriv** – There is no authentication or encryption used in SNMP communications.
  - **AuthNoPriv** – SNMP communications use authentication, but the data is not encrypted (only available for the SNMPv3 security model).
  - **AuthPriv** – SNMP communications use both authentication and encryption (only available for the SNMPv3 security model).
- **Trap Inform** – Notifications are sent as inform messages. Note that this option is only available for version 2c and 3 hosts. (Default: traps are used)
  - **Timeout** – The number of seconds to wait for an acknowledgment before resending an inform message. (Range: 0-2147483647 centiseconds; Default: 1500 centiseconds)
  - **Retry times** – The maximum number of times to resend an inform message if the recipient does not acknowledge receipt. (Range: 0-255; Default: 3)
- **Enable Authentication Traps**<sup>3</sup> – Issues a notification message to specified IP trap managers whenever an invalid community string is submitted during the SNMP access authentication process. (Default: Enabled)
- **Enable Link-up and Link-down Traps**<sup>3</sup> – Issues a notification message whenever a port link is established or broken. (Default: Enabled)

---

3. These are legacy notifications and therefore when used for SNMP Version 3 hosts, they must be enabled in conjunction with the corresponding entries in the Notification View (page 3-55).

**Web** – Click SNMP, Configuration. Enter the IP address and community string for each management station that will receive trap messages, specify the UDP port, trap version, trap security level (for v3 clients), trap inform settings (for v2c/v3 clients), and then click Add. Select the trap types required using the check boxes for Authentication and Link-up/down traps, and then click Apply.

**Trap Managers:**

**Trap Manager Capability: 5**

Current: (none)      New:

	Trap Manager IP Address	<input type="text"/>						
	Trap Manager Community String	<input type="text"/>						
	Trap UDP Port	<input type="text" value="162"/>						
	Trap Version	<input type="text" value="1"/>						
	Trap Security Level	<input type="text" value="noAuthNoPriv"/>						
<input type="checkbox"/>	Trap Inform	<table border="1"> <tr> <td>Timeout (0-2147483647)</td> <td><input type="text"/></td> <td>(1/100 secs)</td> </tr> <tr> <td>Retry times (0-255)</td> <td><input type="text"/></td> <td></td> </tr> </table>	Timeout (0-2147483647)	<input type="text"/>	(1/100 secs)	Retry times (0-255)	<input type="text"/>	
Timeout (0-2147483647)	<input type="text"/>	(1/100 secs)						
Retry times (0-255)	<input type="text"/>							

Enable Authentication Traps:

Enable Link-up and Link-down Traps:

**Figure 3-25 Configuring IP Trap Managers**

**CLI** – This example adds a trap manager and enables both authentication and link-up, link-down traps.

```

Console(config)#snmp-server host 192.168.1.19 private version 2c 4-90
Console(config)#snmp-server enable traps 4-92
  
```

## Configuring SNMPv3 Management Access

To configure SNMPv3 management access to the switch, follow these steps:

1. If you want to change the default engine ID, it must be changed first before configuring other parameters.
2. Specify read and write access views for the switch MIB tree.
3. Configure SNMP user groups with the required security model (i.e., SNMP v1, v2c or v3) and security level (i.e., authentication and privacy).
4. Assign SNMP users to groups, along with their specific authentication and privacy passwords.

### Setting the Local Engine ID

An SNMPv3 engine is an independent SNMP agent that resides on the switch. This engine protects against message replay, delay, and redirection. The engine ID is also used in combination with user passwords to generate the security keys for authenticating and encrypting SNMPv3 packets.

A local engine ID is automatically generated that is unique to the switch. This is referred to as the default engine ID. If the local engine ID is deleted or changed, all SNMP users will be cleared. You will need to reconfigure all existing users.

A new engine ID can be specified by entering 10 to 64 hexadecimal characters (5 to 32 octets in hexadecimal format). If an odd number of characters are specified, a trailing zero is added to the value to fill in the last octet. For example, the value “123456789” is equivalent to “1234567890”.

**Web** – Click SNMP, SNMPv3, Engine ID. Enter an ID of up to 64 hexadecimal characters and then click Save.

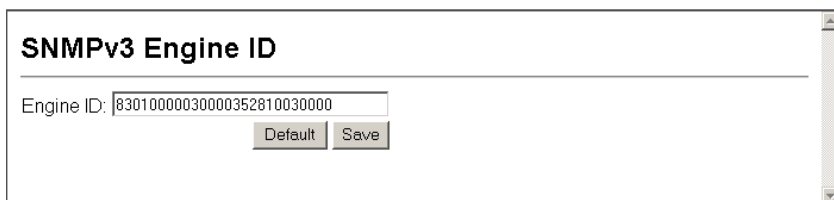

Figure 3-26 Setting an Engine ID

**CLI** – This example sets an SNMPv3 engine ID.

```
Console(config)#snmp-server engine-id local 12345abcdef 4-93
Console(config)#exit
Console#show snmp engine-id 4-94
Local SNMP engineID: 12345abcdef0000000000000000
Local SNMP engineBoots: 1
Console#
```

## Specifying a Remote Engine ID

To send inform messages to an SNMPv3 user on a remote device, you must first specify the engine identifier for the SNMP agent on the remote device where the user resides. The remote engine ID is used to compute the security digest for authenticating and encrypting packets sent to a user on the remote host.

SNMP passwords are localized using the engine ID of the authoritative agent. For informs, the authoritative SNMP agent is the remote agent. You therefore need to configure the remote agent's SNMP engine ID before you can send proxy requests or informs to it. (See "Specifying Trap Managers and Trap Types" on page 3-43 and "Configuring Remote SNMPv3 Users" on page 3-50.)

The engine ID can be specified by entering 10 to 64 hexadecimal characters (5 to 32 octets in hexadecimal format). If an odd number of characters are specified, a trailing zero is added to the value to fill in the last octet. For example, the value "123456789" is equivalent to "1234567890".

**Web** – Click SNMP, SNMPv3, Remote Engine ID. Enter an ID of up to 64 hexadecimal characters and then click Save.

Remote Engine ID	Remote IP Host	Action
<input type="text"/>	<input type="text"/>	<input type="button" value="Add"/>

Figure 3-27 Setting a Remote Engine ID

**CLI** – This example specifies a remote SNMPv3 engine ID.

```

Console(config)#snmp-server engineid remote 54321 192.168.1.19      4-93
Console(config)#exit
Console#show snmp engine-id                                       4-94
Local SNMP engineID: 8000002a8000000000e8666672
Local SNMP engineBoots: 1

Remote SNMP engineID                                             IP address
80000000030004e2b316c54321                                    192.168.1.19
Console#

```

### Configuring SNMPv3 Users

Each SNMPv3 user is defined by a unique name. Users must be configured with a specific security level and assigned to a group. The SNMPv3 group restricts users to a specific read, write, and notify view.

#### Command Attributes

- **User Name** – The name of user connecting to the SNMP agent.  
(Range: 1-32 characters)
- **Group Name** – The name of the SNMP group to which the user is assigned.  
(Range: 1-32 characters)
- **Model** – The user security model; SNMP v1, v2c or v3.
- **Level** – The security level used for the user:
  - **noAuthNoPriv** – There is no authentication or encryption used in SNMP communications. (This is the default for SNMPv3.)
  - **AuthNoPriv** – SNMP communications use authentication, but the data is not encrypted (only available for the SNMPv3 security model).
  - **AuthPriv** – SNMP communications use both authentication and encryption (only available for the SNMPv3 security model).
- **Authentication** – The method used for user authentication.  
(Options: MD5, SHA; Default: MD5)
- **Authentication Password** – A minimum of eight plain text characters is required.
- **Privacy Protocol** – The encryption algorithm use for data privacy; only 56-bit DES is currently available.
- **Privacy Password** – A minimum of eight plain text characters is required.
- **Actions** – Enables the user to be assigned to another SNMPv3 group.

**Web** – Click SNMP, SNMPv3, Users. Click New to configure a user name. In the New User page, define a name and assign it to a group, then click Add to save the configuration and return to the User Name list. To delete a user, check the box next to the user name, then click Delete. To change the assigned group of a user, click Change Group in the Actions column of the users table and select the new group.

**SNMPv3 Users**

New... Delete

<input type="checkbox"/>	User Name	Group Name	Model	Level	Authentication	Privacy	Actions
<input type="checkbox"/>	david	DefaultROGroup	V1	noAuthNoPriv	None	None	Change Group...
<input type="checkbox"/>	chris	snmpv3users	V3	authPriv	MD5	DES56	Change Group...
<input type="checkbox"/>	steve	snmpv3users	V3	authNoPriv	MD5	None	Change Group...

**SNMPv3 Users -- New**

SNMPv3 User:

User Name:

Group Name:

Security Model:

Security Level:

**User Authentication:**

Authentication Protocol:

Authentication Password:

**Data Privacy:**

Privacy Protocol:

Privacy Password:

**SNMPv3 Users -- Edit**

User Name: david

Group Name:

Figure 3-28 Configuring SNMPv3 Users

**CLI** – Use the `snmp-server user` command to configure a new user name and assign it to a group.

```

Console(config)#snmp-server user chris group r&d v3 auth md5
greenpeace priv des56 einstien 4-98
Console(config)#exit
Console#show snmp user 4-99
EngineId: 80000034030001f488f520000
User Name: chris
Authentication Protocol: md5
Privacy Protocol: des56
Storage Type: nonvolatile
Row Status: active

Console#

```

### Configuring Remote SNMPv3 Users

Each SNMPv3 user is defined by a unique name. Users must be configured with a specific security level and assigned to a group. The SNMPv3 group restricts users to a specific read, write, and notify view.

To send inform messages to an SNMPv3 user on a remote device, you must first specify the engine identifier for the SNMP agent on the remote device where the user resides. The remote engine ID is used to compute the security digest for authenticating and encrypting packets sent to a user on the remote host. (See “Specifying Trap Managers and Trap Types” on page 3-43 and “Specifying a Remote Engine ID” on page 3-47.)

#### Command Attributes

- **User Name** – The name of user connecting to the SNMP agent.  
(Range: 1-32 characters)
- **Group Name** – The name of the SNMP group to which the user is assigned.  
(Range: 1-32 characters)
- **Engine ID** – The engine identifier for the SNMP agent on the remote device where the remote user resides. Note that the remote engine identifier must be specified before you configure a remote user. (See “Specifying a Remote Engine ID” on page 44.)
- **Remote IP** – The Internet address of the remote device where the user resides.
- **Security Model** – The user security model; SNMP v1, v2c or v3. (Default: v1)
- **Security Level** – The security level used for the user:
  - noAuthNoPriv – There is no authentication or encryption used in SNMP communications. (This is the default for SNMPv3.)
  - AuthNoPriv – SNMP communications use authentication, but the data is not encrypted (only available for the SNMPv3 security model).
  - AuthPriv – SNMP communications use both authentication and encryption (only available for the SNMPv3 security model).
- **Authentication Protocol** – The method used for user authentication.  
(Options: MD5, SHA; Default: MD5)
- **Authentication Password** – A minimum of eight plain text characters is required.
- **Privacy Protocol** – The encryption algorithm use for data privacy; only 56-bit DES is currently available.
- **Privacy Password** – A minimum of eight plain text characters is required.



**Web** – Click SNMP, SNMPv3, Remote Users. Click New to configure a user name. In the New User page, define a name and assign it to a group, then click Add to save the configuration and return to the User Name list. To delete a user, check the box next to the user name, then click Delete.

### SNMPv3 Remote Users

User Name	Group Name	Engine ID	Model	Level	Authentication	Privacy
<input type="checkbox"/>	mark	r&d	80000000030004e2b316c54321	V3	noAuthNoPriv	None

#### SNMPv3 Remote Users -- New

**SNMPV3 User:**

User Name:

Group Name:    public

Remote IP:

Security Model:

Security Level:

**User Authentication:**

Authentication Protocol:

Authentication Password:

**Data Privacy:**

Privacy Protocol:

Privacy Password:

Figure 3-29 Configuring Remote SNMPv3 Users

**CLI** – Use the `snmp-server user` command to configure a new user name and assign it to a group.

```

Console(config)#snmp-server user mark group r&d remote
192.168.1.19 v3 auth md5 greenpeace priv des56 einstien 4-98
Console(config)#exit
Console#show snmp user 4-99
No user exist

SNMP remote user
EngineId: 80000000030004e2b316c54321
User Name: mark
Authentication Protocol: none
Privacy Protocol: none
Storage Type: nonvolatile
Row Status: active

Console#
  
```

## Configuring SNMPv3 Groups

An SNMPv3 group sets the access policy for its assigned users, restricting them to specific read, write, and notify views. You can use the pre-defined default groups or create new groups to map a set of SNMP users to SNMP views.

### Command Attributes

- **Group Name** – The name of the SNMP group to which the user is assigned. (Range: 1-32 characters)
- **Model** – The user security model; SNMP v1, v2c or v3.
- **Level** – The security level used for the group:
  - noAuthNoPriv – There is no authentication or encryption used in SNMP communications. (This is the default for SNMPv3.)
  - AuthNoPriv – SNMP communications use authentication, but the data is not encrypted (only available for the SNMPv3 security model).
  - AuthPriv – SNMP communications use both authentication and encryption (only available for the SNMPv3 security model).
- **Read View** – The configured view for read access. (Range: 1-64 characters)
- **Write View** – The configured view for write access. (Range: 1-64 characters)
- **Notify View** – The configured view for notifications. (Range: 1-64 characters)

**Table 3-5 Supported Notification Messages**

Object Label	Object ID	Description
<i>RFC 1493 Traps</i>		
newRoot	1.3.6.1.2.1.17.0.1	The newRoot trap indicates that the sending agent has become the new root of the Spanning Tree; the trap is sent by a bridge soon after its election as the new root, e.g., upon expiration of the Topology Change Timer immediately subsequent to its election.
topologyChange	1.3.6.1.2.1.17.0.2	A topologyChange trap is sent by a bridge when any of its configured ports transitions from the Learning state to the Forwarding state, or from the Forwarding state to the Discarding state. The trap is not sent if a newRoot trap is sent for the same transition.
<i>SNMPv2 Traps</i>		
coldStart	1.3.6.1.6.3.1.1.5.1	A coldStart trap signifies that the SNMPv2 entity, acting in an agent role, is reinitializing itself and that its configuration may have been altered.
warmStart	1.3.6.1.6.3.1.1.5.2	A warmStart trap signifies that the SNMPv2 entity, acting in an agent role, is reinitializing itself such that its configuration is unaltered.

Table 3-5 Supported Notification Messages (Continued)

Object Label	Object ID	Description
linkDown*	1.3.6.1.6.3.1.1.5.3	A linkDown trap signifies that the SNMP entity, acting in an agent role, has detected that the ifOperStatus object for one of its communication links is about to enter the down state from some other state (but not from the notPresent state). This other state is indicated by the included value of ifOperStatus.
linkUp*	1.3.6.1.6.3.1.1.5.4	A linkUp trap signifies that the SNMP entity, acting in an agent role, has detected that the ifOperStatus object for one of its communication links left the down state and transitioned into some other state (but not into the notPresent state). This other state is indicated by the included value of ifOperStatus.
authenticationFailure*	1.3.6.1.6.3.1.1.5.5	An authenticationFailure trap signifies that the SNMPv2 entity, acting in an agent role, has received a protocol message that is not properly authenticated. While all implementations of the SNMPv2 must be capable of generating this trap, the snmpEnableAuthenTraps object indicates whether this trap will be generated.
<i>RMON Events (V2)</i>		
risingAlarm	1.3.6.1.2.1.16.0.1	The SNMP trap that is generated when an alarm entry crosses its rising threshold and generates an event that is configured for sending SNMP traps.
fallingAlarm	1.3.6.1.2.1.16.0.2	The SNMP trap that is generated when an alarm entry crosses its falling threshold and generates an event that is configured for sending SNMP traps.
<i>Private Traps<sup>f</sup></i>		
swPowerStatusChangeTrap	1.3.6.1.4.1.236.4.1.12.1.101.2.1.0.1	This trap is sent when the power state changes.
swIpFilterRejectTrap	1.3.6.1.4.1.236.4.1.12.1.101.2.1.0.40	This trap is sent when an incorrect IP address is rejected by the IP Filter.
pethPsePortOnOffNotification	1.3.6.1.4.1.236.4.1.12.1.101.173.2.1.0.43	This notification indicates if a PSE (Power Sourcing Equipment) Port is delivering power to the PD (Powered Device). This notification is sent on every status change except in search mode.
pethPsePortPowerMaintenanceStatusNotification	1.3.6.1.4.1.236.4.1.12.1.101.173.2.1.0.44	This notification indicates a Port Change Status and is sent on every status change.

### 3 Configuring the Switch

Table 3-5 Supported Notification Messages (Continued)

Object Label	Object ID	Description
pethMainPower UsageOnNotification	1.3.6.1.4.1.236.4.1.12.1.101.173.2.1.0.45	This notification indicates PSE Threshold usage indication is on; the power usage is above the threshold.
pethMainPower UsageOffNotification	1.3.6.1.4.1.236.4.1.12.1.101.173.2.1.0.46	This notification indicates that the PSE Threshold usage indication is off; the usage power is below the threshold.

\* These are legacy notifications and therefore must be enabled in conjunction with the corresponding traps on the SNMP Configuration menu.

† The iES4028FP MIB Object Identifier is 1.3.6.1.4.1.236.4.1.12.1.101.

**Web** – Click SNMP, SNMPv3, Groups. Click New to configure a new group. In the New Group page, define a name, assign a security model and level, and then select read and write views. Click Add to save the new group and return to the Groups list. To delete a group, check the box next to the group name, then click Delete.

**SNMPv3 Groups**

New... Delete

	Group Name	Model	Level	Read View	Write View	Notify View
<input type="checkbox"/>	public	V1	noAuthNoPriv	defaultview	none	none
<input type="checkbox"/>	public	V2C	noAuthNoPriv	defaultview	none	none
<input type="checkbox"/>	private	V1	noAuthNoPriv	defaultview	defaultview	none
<input type="checkbox"/>	private	V2C	noAuthNoPriv	defaultview	defaultview	none
<input type="checkbox"/>	secure-users	V3	authP			

**Group Properties:**

Group Name:

Security Model:

Security Level:

**SNMPv3 Views:**

Read View:    defaultview

Write View:    defaultview

Notify View:    defaultview

Back Add

Figure 3-30 Configuring SNMPv3 Groups

**CLI** – Use the **snmp-server group** command to configure a new group, specifying the security model and level, and restricting MIB access to defined read and write views.

```
Console(config)#snmp-server group secure-users v3 priv          4-96
  read defaultview write defaultview notify defaultview
Console(config)#exit
Console#show snmp group                                       4-97
:
:
Group Name: secure-users
Security Model: v3
Read View: defaultview
Write View: defaultview
Notify View: defaultview
Storage Type: nonvolatile
Row Status: active
Console#
```

### Setting SNMPv3 Views

SNMPv3 views are used to restrict user access to specified portions of the MIB tree. The predefined view “defaultview” includes access to the entire MIB tree.

#### Command Attributes

- **View Name** – The name of the SNMP view. (Range: 1-64 characters)
- **View OID Subtrees** – Shows the currently configured object identifiers of branches within the MIB tree that define the SNMP view.
- **Edit OID Subtrees** – Allows you to configure the object identifiers of branches within the MIB tree. Wild cards can be used to mask a specific portion of the OID string.
- **Type** – Indicates if the object identifier of a branch within the MIB tree is included or excluded from the SNMP view.

### 3 Configuring the Switch

**Web** – Click SNMP, SNMPv3, Views. Click New to configure a new view. In the New View page, define a name and specify OID subtrees in the switch MIB to be included or excluded in the view. Click Back to save the new view and return to the SNMPv3 Views list. For a specific view, click on View OID Subtrees to display the current configuration, or click on Edit OID Subtrees to make changes to the view settings. To delete a view, check the box next to the view name, then click Delete.

The screenshot displays the 'SNMPv3 Views' configuration page. At the top, there are 'New...' and 'Delete' buttons. Below is a table listing existing views:

	Name	OID Subtrees	Actions
<input type="checkbox"/>	readaccess	<a href="#">View OID Subtrees</a>	<a href="#">[Edit OID Subtrees...]</a>
<input type="checkbox"/>	defaultview	<a href="#">View OID Subtrees</a>	<a href="#">[Edit OID Subtrees...]</a>
<input type="checkbox"/>	writeaccess	<a href="#">View OID Subtrees</a>	<a href="#">[Edit OID Subtrees...]</a>

Arrows from the 'View OID Subtrees' links in the table point to the 'SNMPv3 Views -- View' panel, which shows details for the 'readaccess' view:

View: readaccess

OID Subtree	Type
1.3.6.1.2	Included

Below this is a 'Back' button.

Arrows from the '[Edit OID Subtrees...]' links in the table point to the 'SNMPv3 View -- Edit' panel. This panel includes a 'View Name' field, a 'Current:' list containing '1 (Included)', and a 'New:' section with an 'OID Subtree' input field, a 'Type' dropdown menu set to 'Included', and 'Back', '<< Add', and 'Remove' buttons.

Figure 3-31 Configuring SNMPv3 Views

**CLI** – Use the **snmp-server view** command to configure a new view. This example view includes the MIB-2 interfaces table, and the wildcard mask selects all index entries.

```
Console(config)#snmp-server view ifEntry.a
  1.3.6.1.2.1.2.2.1.1.* included                               4-94
Console(config)#exit
Console#show snmp view                                       4-95
View Name: ifEntry.a
Subtree OID: 1.3.6.1.2.1.2.2.1.1.*
View Type: included
Storage Type: nonvolatile
Row Status: active

View Name: readaccess
Subtree OID: 1.3.6.1.2
View Type: included
Storage Type: nonvolatile
Row Status: active

View Name: defaultview
Subtree OID: 1
View Type: included
Storage Type: nonvolatile
Row Status: active

Console#
```

## User Authentication

You can configure this switch to authenticate users logging into the system for management access using local or remote authentication methods. Port-based authentication using IEEE 802.1X can also be configured to control either management access to the uplink ports or client access to the data ports. This switch provides secure network management access<sup>4</sup> using the following options:

- User Accounts – Manually configure access rights on the switch for specified users.
- Authentication Settings – Use remote authentication to configure access rights.
- AAA – Provides a framework for configuring access control on the switch.
- HTTPS Settings – Provide a secure web connection.
- SSH Settings – Provide a secure shell (for secure Telnet access).
- Port Security – Configure secure addresses for individual ports.
- 802.1X – Use IEEE 802.1X port authentication to control access to specific ports.
- IP Filter – Filters management access to the web, SNMP or Telnet interface.

4. For other methods of controlling client access, see “General Security Measures” on page 3-96.

## Configuring User Accounts

The guest only has read access for most configuration parameters. However, the administrator has write access for all parameters governing the onboard agent. You should therefore assign a new administrator password as soon as possible, and store it in a safe place.

The default guest name is “guest” with the password “guest.” The default administrator name is “admin” with the password “admin.”

### Command Attributes

- **Account List** – Displays the current list of user accounts and associated access levels. (Defaults: admin, and guest)
- **New Account** – Displays configuration settings for a new account.
  - **User Name** – The name of the user.  
(Maximum length: 8 characters; maximum number of users: 16)
  - **Access Level** – Specifies the user level.  
(Options: Normal and Privileged)
  - **Password** – Specifies the user password.  
(Range: 0-8 characters plain text, case sensitive)
- **Change Password** – Sets a new password for the specified user name.
- **Add/Remove** – Adds or removes an account from the list.

**Web** – Click Security, User Accounts. To configure a new user account, specify a user name, select the user’s access level, then enter a password and confirm it. Click Add to save the new user account and add it to the Account List. To change the password for a specific user, enter the user name and new password, confirm the password by entering it again, then click Apply.

The screenshot shows a web interface titled "User Accounts". It is divided into three main sections:

- Account List:** A table listing existing users: "admin (Privileged)" and "guest (Normal)". To the right of the table are two buttons: "<< Add" and "Remove".
- New Account:** A form with four fields: "User Name" (containing "bob"), "Access Level" (a dropdown menu set to "Normal"), "Password" (with a masked input field), and "Confirm Password" (with a masked input field).
- Change Password:** A form with three fields: "User Name", "New Password", and "Confirm Password", followed by a "Change" button.

Figure 3-32 Access Levels



**CLI** – Assign a user name to access-level 15 (i.e., administrator), then specify the password.

```
Console(config)#username bob access-level 15
Console(config)#username bob password 0 smith
Console(config)#
```

4-101

## Configuring Local/Remote Logon Authentication

Use the Authentication Settings menu to restrict management access based on specified user names and passwords. You can manually configure access rights on the switch, or you can use a remote access authentication server based on RADIUS or TACACS+ protocols.

Remote Authentication Dial-in User Service (RADIUS) and Terminal Access Controller Access Control System Plus (TACACS+) are logon authentication protocols that use software running on a central server to control access to RADIUS-aware or TACACS-aware devices on the network. An authentication server contains a database of multiple user name/password pairs with associated privilege levels for each user that requires management access to the switch.

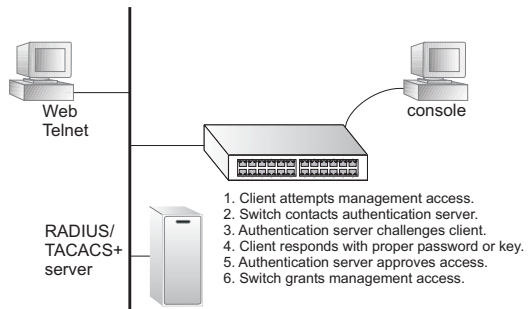

RADIUS uses UDP while TACACS+ uses TCP. UDP only offers best effort delivery, while TCP offers a connection-oriented transport. Also, note that RADIUS encrypts only the password in the access-request packet from the client to the server, while TACACS+ encrypts the entire body of the packet.

### Command Usage

- By default, management access is always checked against the authentication database stored on the local switch. If a remote authentication server is used, you must specify the authentication sequence and the corresponding parameters for the remote authentication protocol. Local and remote logon authentication control management access via the console port, web browser, or Telnet.
- RADIUS and TACACS+ logon authentication assign a specific privilege level for each user name/password pair. The user name, password, and privilege level must be configured on the authentication server. The encryption methods used for the authentication process must also be configured or negotiated between the authentication server and logon client. This switch can pass authentication messages between the server and client that have been encrypted using MD5 (Message-Digest 5), TLS (Transport Layer Security), or TTLS (Tunneled Transport Layer Security).

### 3 Configuring the Switch

- You can specify up to three authentication methods for any user to indicate the authentication sequence. For example, if you select (1) RADIUS, (2) TACACS and (3) Local, the user name and password on the RADIUS server is verified first. If the RADIUS server is not available, then authentication is attempted using the TACACS+ server, and finally the local user name and password is checked.

#### Command Attributes

- **Authentication** – Select the authentication, or authentication sequence required:
  - **Local** – User authentication is performed only locally by the switch.
  - **Radius** – User authentication is performed using a RADIUS server only.
  - **TACACS** – User authentication is performed using a TACACS+ server only.
  - [authentication sequence] – User authentication is performed by up to three authentication methods in the indicated sequence.

- **RADIUS Settings**

- **Global** – Provides globally applicable RADIUS settings.
- **ServerIndex** – Specifies one of five RADIUS servers that may be configured. The switch attempts authentication using the listed sequence of servers. The process ends when a server either approves or denies access to a user.
- **Server IP Address**<sup>5</sup> – Address of the RADIUS server.
- **Authentication Port Number** – Network (UDP) port of authentication server used for authentication messages. (Range: 1-65535; Default: 1812)
- **Accounting Port Number** – UDP port on authentication server used for accounting messages. (Range: 1-65535; Default: 1813)
- **Number of Server Transmits** – Number of times the switch tries to authenticate logon access via the authentication server. (Range: 1-30; Default: 2)
- **Timeout for a reply** – The number of seconds the switch waits for a reply from the RADIUS server before it resends the request. (Range: 1-65535; Default: 5)

- **RADIUS Attributes**

**NAS IP Address** – Specifies the IP address of the Network Access Server (NAS) to use in the attribute 4 address field in packets sent to the RADIUS server. (Default: The IP address of the interface that connects the switch to the RADIUS server.)

The IP address of the interface connecting the switch (i.e., the NAS) to the RADIUS server is used in the IP headers of RADIUS packets sent to the server. This address is also used by default in the attribute 4 field inside of RADIUS packets sent to the server.

It may be necessary for certain AAA processes to configure the attribute 4 field to an address other than that of the switch's connecting interface. However, setting this field to an address other than that of the actual interface connecting the switch to the RADIUS server will not affect the IP address used inside the IP headers of RADIUS packets sent from the switch.

---

5. A Server Index must be selected to display this item.

Some AAA clients may try to change the attribute 4 address. Setting the NAS IP address in the attribute 4 field prevents these clients from changing this address.

- **TACACS Settings**

- **Global** – Provides globally applicable TACACS+ settings.
- **ServerIndex** – Specifies the index number of the server to be configured. The switch currently supports only one TACACS+ server.
- **Server IP Address**<sup>5</sup> – Address of the TACACS+ server.
- **Server Port Number** – Network (TCP) port of TACACS+ server used for authentication messages. (Range: 1-65535; Default: 49)
- **Number of Server Transmits** – Number of times the switch tries to authenticate logon access via the authentication server. (Range: 1-30; Default: 2)
- **Timeout for a Reply** – The number of seconds the switch waits for a reply from the RADIUS server before it resends the request. (Range: 1-540; Default: 5)

**Note:** The local switch user database has to be set up by manually entering user names and passwords using the Web or CLI. (See “Configuring User Accounts” on page 3-58 or “username” on page 4-101)

### 3 Configuring the Switch

**Web** – Click Security, Authentication Settings. To configure local or remote authentication preferences, specify the authentication sequence (i.e., one to three methods), fill in the parameters for RADIUS or TACACS+ authentication if selected, and click Apply.

**Authentication Settings**

Authentication

RADIUS Settings:

Global | ServerIndex:  1  2  3  4  5

Authentication Port Number (1-65535)	<input type="text" value="1812"/>
Accounting Port Number (1-65535)	<input type="text" value="1813"/>
Number of Server Transmits (1-30)	<input type="text" value="2"/>
Timeout for a reply (1-65535)	<input type="text" value="5"/> (seconds)

RADIUS Attributes:

NAS IP Address	<input type="text" value="0.0.0.0"/>
----------------	--------------------------------------

TACACS Settings:

Global | ServerIndex:  1

Server Port Number (1-65535)	<input type="text" value="49"/>
Number of Server Transmits (1-30)	<input type="text" value="2"/>
Timeout for a reply (1-540)	<input type="text" value="5"/> (seconds)

**Figure 3-33 Authentication Settings**

**CLI – Specify all the required parameters to enable logon authentication.**

```

Console(config)#authentication login radius 4-103
Console(config)#radius-server auth-port 181 4-106
Console(config)#radius-server acct-port 183 4-106
Console(config)#radius-server retransmit 5 4-108
Console(config)#radius-server timeout 10 4-108
Console(config)#radius-server 1 host 192.168.1.25 4-105
Console(config)#radius-server attribute 4 192.168.1.1 4-107
Console(config)#end
Console#show radius-server 4-109

Remote RADIUS Server Configuration:

Global Settings:
Authentication Port : 1812
Accounting Port : 1813
Retransmit Times : 5
Request Timeout : 10 seconds

Attributes:
NAS-IP-Address (4) : 192.168.1.1

Server 1:
Server IP Address : 192.168.1.25
Authentication Port : 1812
Accounting Port : 1813
Retransmit Times : 5
Request Timeout : 10 seconds

Radius server group:
Group Name Member Index
-----
radius 1
Console#

```

### 3 Configuring the Switch

```
Console#configure
Console(config)#authentication login tacacs 4-103
Console(config)#tacacs-server 1 host 10.20.30.40 4-110
Console(config)#tacacs-server port 200 4-110
Console(config)#tacacs-server retransmit 5 4-111
Console(config)#tacacs-server timeout 10 4-112
Console(config)#tacacs-server key green 4-111
Console#show tacacs-server 4-113

Remote TACACS+ server configuration:

Global Settings:
  Server Port Number:          200
  Retransmit Times   :          5
  Request Times      :          10

Server 1:
  Server IP address:          10.20.30.40
  Server port number:          200
  Retransmit Times   :          5
  Request Times      :          10

Tacacs server group:
Group Name             Member Index
-----
tacacs+                1
Console(config)#
```

## Configuring Encryption Keys

The Encryption Key feature provides a central location for the management of all RADIUS and TACACS+ server encryption keys.

### Command Attributes

#### • RADIUS Settings

- **Global** – Provides globally applicable RADIUS encryption key settings.
- **Server Index** – Specifies one of five RADIUS servers for which an encryption key may be configured.
- **Secret Text String** – Encryption key used to authenticate logon access for client. Do not use blank spaces in the string. (Maximum length: 48 characters)
- **Confirm Secret Text String** – Re-type the string entered in the previous field to ensure no errors were made. The switch will not change the encryption key if these two fields do not match.
- **Change** – Clicking this button adds or modifies the selected encryption key.

#### • TACACS+ Settings

- **Global** – Provides globally applicable TACACS+ encryption key settings.
- **Server Index** – Specifies the index number of the TACACS+ server for which an encryption key may be configured. The switch currently supports only one TACACS+ server.
- **Secret Text String** – Encryption key used to authenticate logon access for client. Do not use blank spaces in the string. (Maximum length: 48 characters)

- **Confirm Secret Text String** – Re-type the string entered in the previous field to ensure no errors were made. The switch will not change the encryption key if these two fields do not match.
- **Change** – Clicking this button adds or modifies the selected encryption key.

**Web** – Click Security, Encryption Key. Choose the appropriate RADIUS or TACACS+ ServerIndex, enter Secret Text String and confirm it, then click Change.

### Encryption Key

---

RADIUS Settings:

Global | ServerIndex: 
  1 
  2 
  3 
  4 
  5

Secret Text String	
Confirm Secret Text String	<input type="button" value="Change"/>

TACACS Settings:

Global | ServerIndex: 
  1

Secret Text String	
Confirm Secret Text String	<input type="button" value="Change"/>

Figure 3-34 Encryption Key Settings

**CLI** – This example sets a global encryption key for RADIUS and TACACS servers.

```

Console(config)#radius-server key green          4-107
Console(config)#tacacs-server key green         4-111
Console(config)#
  
```

## AAA Authorization and Accounting

The Authentication, authorization, and accounting (AAA) feature provides the main framework for configuring access control on the switch. The three security functions can be summarized as follows:

- Authentication — Identifies users that request access to the network.
- Authorization — Determines if users can access specific services.
- Accounting — Provides reports, auditing, and billing for services that users have accessed on the network.

The AAA functions require the use of configured RADIUS or TACACS+ servers in the network. The security servers can be defined as sequential groups that are then applied as a method for controlling user access to specified services. For example, when the switch attempts to authenticate a user, a request is sent to the first server in the defined group, if there is no response the second server will be tried, and so on. If at any point a pass or fail is returned, the process stops.

The switch supports the following AAA features:

- Accounting for IEEE 802.1X authenticated users that access the network through the switch.

### 3 Configuring the Switch

- Accounting for users that access management interfaces on the switch through the console and Telnet.
- Accounting for commands that users enter at specific CLI privilege levels.
- Authorization of users that access management interfaces on the switch through the console and Telnet.

To configure AAA on the switch, you need to follow this general process:

1. Configure RADIUS and TACACS+ server access parameters. See “Configuring Local/Remote Logon Authentication” on page 3-59.
2. Define RADIUS and TACACS+ server groups to support the accounting and authorization of services.
3. Define a method name for each service to which you want to apply accounting or authorization and specify the RADIUS or TACACS+ server groups to use.
4. Apply the method names to port or line interfaces.

**Note:** This guide assumes that RADIUS and TACACS+ servers have already been configured to support AAA. The configuration of RADIUS and TACACS+ server software is beyond the scope of this guide, refer to the documentation provided with the RADIUS or TACACS+ server software.

#### Configuring AAA RADIUS Group Settings

The AAA RADIUS Group Settings screen defines the configured RADIUS servers to use for accounting and authorization.

##### Command Attributes

- **Group Name** - Defines a name for the RADIUS server group. (1-255 characters)
- **Server Index** - Specifies the RADIUS server and sequence to use for the group. (Range: 1-5)

When specifying the index for a RADIUS sever, the server index must already be defined (see “Configuring Local/Remote Logon Authentication” on page 3-59).

**Web** – Click Security, AAA, Radius Group Settings. Enter the RADIUS group name, followed by the number of the server, then click Add.

#### AAA RADIUS Group Settings

Group Name	Server Index	Action
radius	1: 1 2: 2 3: 3 4: 4 5: 5	Remove
tps-radius	1: 5 2: 4 3: 2 4: 1 5: 3	Remove
	1: 2: 3: 4: 5:	Add

Figure 3-35 AAA Radius Group Settings



**CLI** – Specify the group name for a list of RADIUS servers, and then specify the index number of a RADIUS server to add it to the group.

```

Console(config)#aaa group server radius tps-radius      4-114
Console(config-sg-radius)#server 1                    4-115
Console(config-sg-radius)#server 2                    4-115
Console(config-sg-radius)#

```

## Configuring AAA TACACS+ Group Settings

The AAA TACACS+ Group Settings screen defines the configured TACACS+ servers to use for accounting and authorization.

### Command Attributes

- **Group Name** - Defines a name for the TACACS+ server group. (1-255 characters)
- **Server** - Specifies the TACACS+ server to use for the group. (Range: 1)  
When specifying the index for a TACACS+ server, the server index must already be defined (see “Configuring Local/Remote Logon Authentication” on page 3-59).

**Web** – Click Security, AAA, TACACS+ Group Settings. Enter the TACACS+ group name, followed by the number of the server, then click Add.

Group Name	Server	Action
tacacs+	1	Remove
tps-tacacs+	1	Remove
	0	Add

Figure 3-36 AAA TACACS+ Group Settings

**CLI** – Specify the group name for a list of TACACS+ servers, and then specify the index number of a TACACS+ server to add it to the group.

```

Console(config)#aaa group server tacacs+ tps-tacacs+  4-114
Console(config-sg-tacacs+)#server 1                  4-115
Console(config-sg-tacacs+)#

```

## Configuring AAA Accounting

AAA accounting is a feature that enables the accounting of requested services for billing or security purposes.

### Command Attributes

- **Method Name** – Specifies an accounting method for service requests.  
The “default” methods are used for a requested service if no other methods have been defined. (Range: 1-255 characters)  
The method name is only used to describe the accounting method(s) configured on the specified accounting servers, and do not actually send any information to

### 3 Configuring the Switch

the servers about the methods to use.

- **Service Request** – Specifies the service as either 802.1X (user accounting) or Exec (administrative accounting for local console, Telnet, or SSH connections).
- **Accounting Notice** – Records user activity from log-in to log-off point.
- **Group Name** - Specifies the accounting server group. (Range: 1-255 characters) The group names “radius” and “tacacs+” specifies all configured RADIUS and TACACS+ hosts (see “Configuring Local/Remote Logon Authentication” on page 3-59). Any other group name refers to a server group configured on the RADIUS or TACACS+ Group Settings pages.

**Web** – Click Security, AAA, Accounting, Settings. To configure a new accounting method, specify a method name and a group name, then click Add.

Method Name	Service Request	Accounting Notice	Group Name	Action
default	802.1X	start-stop	radius	Remove
default	EXEC	start-stop	tacacs+	Remove
default	Commands 0	start-stop	tacacs+	Remove
default	Commands 1	start-stop	tacacs+	Remove
default	Commands 2	start-stop	tacacs+	Remove
default	Commands 3	start-stop	tacacs+	Remove
default	Commands 4	start-stop	tacacs+	Remove
default	Commands 5	start-stop	tacacs+	Remove
default	Commands 6	start-stop	tacacs+	Remove
default	Commands 7	start-stop	tacacs+	Remove
default	Commands 8	start-stop	tacacs+	Remove
default	Commands 9	start-stop	tacacs+	Remove
default	Commands 10	start-stop	tacacs+	Remove
default	Commands 11	start-stop	tacacs+	Remove
default	Commands 12	start-stop	tacacs+	Remove
default	Commands 13	start-stop	tacacs+	Remove
default	Commands 14	start-stop	tacacs+	Remove
default	Commands 15	start-stop	tacacs+	Remove
tps-method	802.1X	start-stop	tps-radius	Remove
<input type="text"/>	802.1X <input type="text"/> Privilege Level (0-15): <input type="text"/>	start-stop	<input type="text"/>	Add

Figure 3-37 AAA Accounting Settings

**CLI** – Specify the accounting method required, followed by the chosen parameters.

```
Console(config)#aaa accounting dot1x tps start-stop group radius 4-116
Console(config)#
```

## AAA Accounting Update

This feature sets the interval at which accounting updates are sent to accounting servers.

### Command Attributes

**Periodic Update** - Specifies the interval at which the local accounting service updates information to the accounting server. (Range: 1-2147483647 minutes; Default: Disabled)

**Web** – Click Security, AAA, Accounting, Periodic Update. Enter the required update interval and click Apply.

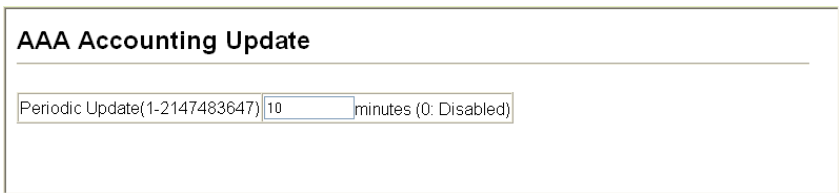

AAA Accounting Update

Periodic Update(1-2147483647)  minutes (0: Disabled)

Figure 3-38 AAA Accounting Update

**CLI** – This example sets the periodic accounting update interval at 10 minutes.

```
Console(config)#aaa accounting update periodic 10  
Console(config)#
```

4-119

### 3 Configuring the Switch

#### AAA Accounting 802.1X Port Settings

This feature applies the specified accounting method to an interface.

#### Command Attributes

- **Port/Trunk** - Specifies a port or trunk number.
- **Method Name** - Specifies a user defined method name to apply to the interface. This method must be defined in the AAA Accounting Settings menu (page 3-66). (Range: 1-255 characters)

**Web** – Click Security, AAA, Accounting, 802.1X Port Settings. Enter the required accounting method and click Apply.

#### AAA Accounting 802.1X Port Settings

---

Port	Method Name	Trunk
1	<input type="text" value="tps-method"/>	
2	<input type="text" value="tps-method"/>	
3	<input type="text" value="tps-method"/>	
4	<input type="text" value="tps-method"/>	
5	<input type="text" value="tps-method"/>	
6	<input type="text" value="tps-method"/>	
7	<input type="text" value="default"/>	
8	<input type="text" value="default"/>	
9	<input type="text" value="default"/>	
10	<input type="text" value="default"/>	

Figure 3-39 AAA Accounting 802.1X Port Settings

**CLI** – Specify the accounting method to apply to the selected interface.

```
Console(config)#interface ethernet 1/2  
Console(config-if)#accounting dot1x tps-method  
Console(config-if)#
```

4-119

## AAA Accounting Exec Command Privileges

This feature specifies a method name to apply to commands entered at specific CLI privilege levels.

### Command Attributes

- **Commands Privilege Level** - The CLI privilege levels (0-15).
- **Console/Telnet** - Specifies a user-defined method name to apply to commands entered at the specified CLI privilege level.

**Web** – Click Security, AAA, Accounting, Command Privileges. Enter a defined method name for console and Telnet privilege levels. Click Apply.

### AAA Accounting EXEC Command Privileges

Commands Privilege Level	Console	Telnet
0	default	default
1	default	default
2	default	default
3	default	default
4	default	default
5	default	default
6	default	default
7	default	default
8	default	default
9	default	default
10	default	default
11	default	default
12	default	default
13	default	default
14	default	default
15	tps-method	tps-method

Figure 3-40 AAA Accounting Exec Command Privileges

**CLI** – Specify the accounting method to use for console and Telnet privilege levels.

```

Console(config)#line console                                4-41
Console(config-line)#accounting commands 15 tps-method    4-120
Console(config-line)#exit
Console(config)#line vty
Console(config-line)#accounting commands 15 tps-method
Console(config-line)#
  
```

### 3 Configuring the Switch

#### AAA Accounting Exec Settings

This feature specifies a method name to apply to console and Telnet connections.

##### Command Attributes

**Method Name** - Specifies a user defined method name to apply to console and Telnet connections.

**Web** – Click Security, AAA, Accounting, Exec Settings. Enter a defined method name for console and Telnet connections, and click Apply.

#### AAA Accounting Exec Settings

---

	Method Name
Console	<input type="text" value="tps-method"/>
Telnet	<input type="text" value="tps-method"/>

Figure 3-41 AAA Accounting Exec Settings

**CLI** – Specify the accounting method to use for Console and Telnet interfaces.

```
Console(config)#line console 4-41
Console(config-line)#accounting exec tps-method 4-120
Console(config-line)#exit
Console(config)#line vty
Console(config-line)#accounting exec tps-method
Console(config-line)#
```

#### AAA Accounting Summary

This feature displays all accounting configured accounting methods, the methods applied to specified interfaces, and basic accounting information recorded for user sessions.

##### Command Attributes

###### AAA Accounting Summary

- **Accounting Type** - Displays the accounting service.
- **Method List** - Displays the user-defined or default accounting method.
- **Group List** - Displays the accounting server group.
- **Interface** - Displays the port or trunk to which these rules apply. (This field is null if the accounting method and associated server group has not been assigned to an interface.)

###### AAA Accounting Statistics Summary

- **Accounting Type** - Displays the accounting service.
- **User Name** - Displays a registered user name.
- **Interface** - Displays the receive port number through which this user accessed the switch.
- **Time Elapsed** - Displays the length of time this entry has been active.

**Web – Click Security, AAA, Summary.**

AAA Accounting Summary			
<b>AAA Accounting Summary</b>			
Accounting Type	Method List	Group List	Interface
802.1X	default	radius	
802.1X	tps-method	tps-radius	
EXEC	default	tacacs+	
Command 0	default	tacacs+	
Command 1	default	tacacs+	
Command 2	default	tacacs+	
Command 3	default	tacacs+	
Command 4	default	tacacs+	
Command 5	default	tacacs+	
Command 6	default	tacacs+	
Command 7	default	tacacs+	
Command 8	default	tacacs+	
Command 9	default	tacacs+	
Command 10	default	tacacs+	

AAA Accounting Statistics Summary			
Total entries: 2			
Accounting Type	User Name	Incoming Port	Time Elapsed
dot1x	testpc	eth 1/1	00:18:29
exec	admin	vty 0	00:18:54

**Figure 3-42 AAA Accounting Summary**

**CLI – Use the following command to display the currently applied accounting methods, and registered users.**

```

Console#show accounting
Accounting Type : dot1x
  Method List   : default
  Group List    : radius
  Interface     :

  Method List   : tps-method
  Group List    : tps-radius
  Interface     :

Accounting Type : Exec
  Method List   : default
  Group List    : tacacs+
  Interface     :

Accounting Type : Commands 0
  Method List   : default
  Group List    : tacacs+
  Interface     :
  
```

4-122

### 3 Configuring the Switch

```
Console#show accounting statistics
Total entries: 3
Accounting type : dot1x
  Username      : testpc
  Interface     : eth 1/1
  Time elapsed since connected: 00:24:44

Accounting type : exec
  Username      : admin
  Interface     : vty 0
  Time elapsed since connected: 00:25:09

Console#
```

#### Authorization Settings

AAA authorization is a feature that verifies a user has access to specific services.

#### Command Attributes

- **Method Name** – Specifies an authorization method for service requests. The “default” method is used for a requested service if no other methods have been defined. (Range: 1-255 characters)
- **Service Request** – Specifies the service as Exec (authorization for local console or Telnet connections).
- **Group Name** - Specifies the authorization server group. (Range: 1-255 characters)

The group name “tacacs+” specifies all configured TACACS+ hosts (see “Configuring Local/Remote Logon Authentication” on page 3-59). Any other group name refers to a server group configured on the TACACS+ Group Settings page. Authorization is only supported for TACACS+ servers.

**Web** – Click Security, AAA, Authorization, Settings. To configure a new authorization method, specify a method name and a group name, select the service, then click Add.

#### AAA Authorization Settings

Method Name	Service Request	Group Name	Action
default	Exec	tacacs+	<input type="button" value="Remove"/>
auth-method	Exec	tps-tacacs+	<input type="button" value="Remove"/>
<input type="text"/>	EXEC <input type="button" value="v"/>	<input type="text"/>	<input type="button" value="Add"/>

Figure 3-43 AAA Authorization Settings

**CLI** – Specify the authorization method required and the server group.

```
Console(config)#aaa authorization exec default group tacacs+
Console(config)#
```

4-121



## Authorization EXEC Settings

This feature specifies an authorization method name to apply to console and Telnet connections.

### Command Attributes

**Method Name** - Specifies a user-defined method name to apply to console and Telnet connections.

**Web** – Click Security, AAA, Authorization, Exec Settings. Enter a defined method name for console and Telnet connections, and click Apply.

### AAA Authorization Exec Settings

---

	Method Name
Console	<input style="width: 80%;" type="text" value="tps-auth"/>
Telnet	<input style="width: 80%;" type="text" value="tps-auth"/>

Figure 3-44 AAA Authorization Exec Settings

**CLI** – Specify the authorization method to use for Console and Telnet interfaces.

```

Console(config)#line console                                4-41
Console(config-line)#authorization exec tps-auth           4-122
Console(config-line)#exit
Console(config)#line vty
Console(config-line)#authorization exec tps-auth
Console(config-line)#
  
```

### 3 Configuring the Switch

#### Authorization Summary

The Authorization Summary displays the configured authorization methods and the interfaces to which they are applied.

#### Command Attributes

- **Accounting Type** - Displays the accounting service.
- **Method List** - Displays the user-defined or default authorization method.
- **Group List** - Displays the authorization server group.
- **Interface** - Displays the console or Telnet interface to which the authorization method applies. (This field is null if the authorization method and associated server group has not been assigned.)

**Web** – Click Security, AAA, Authorization, Summary.

AAA Authorization Summary			
Accounting Type	Method List	Group List	Interface
Exec	default	tacacs+	Console
Exec	auth-method	tps-tacacs+	

Figure 3-45 AAA Authorization Summary

**CLI** – This example displays the configured authorization methods and the interfaces to which they are applied.

```
Console#show accounting 4-122
Accounting type: dot1x
  Method list: default
  Group list: radius
  Interface:

  Method list: tps
  Group list: radius
  Interface: eth 1/2

Accounting type: Exec
  Method list: default
  Group list: radius
  Interface: vty

Console#
```

## Configuring HTTPS

You can configure the switch to enable the Secure Hypertext Transfer Protocol (HTTPS) over the Secure Socket Layer (SSL), providing secure access (i.e., an encrypted connection) to the switch's web interface.

### Command Usage

- Both the HTTP and HTTPS service can be enabled independently on the switch. However, you cannot configure both services to use the same UDP port. (HTTP can only be configured through the CLI using the **ip http secure-server** command described on page 4-124.)
- If you enable HTTPS, you must indicate this in the URL that you specify in your browser: `https://device[:port_number]`
- When you start HTTPS, the connection is established in this way:
  - The client authenticates the server using the server's digital certificate.
  - The client and server negotiate a set of security protocols to use for the connection.
  - The client and server generate session keys for encrypting and decrypting data.
- The client and server establish a secure encrypted connection. A padlock icon should appear in the status bar for Internet Explorer 5.x or above, Netscape 6.2 or above, and Mozilla Firefox 2.0.0.0 or above.
- The following web browsers and operating systems currently support HTTPS:

Table 3-6 HTTPS System Support

Web Browser	Operating System
Internet Explorer 5.0 or later	Windows 98, Windows NT (with service pack 6a), Windows 2000, Windows XP
Netscape 6.2 or later	Windows 98, Windows NT (with service pack 6a), Windows 2000, Windows XP, Solaris 2.6
Mozilla Firefox 2.0.0.0 or later	Windows 2000, Windows XP, Linux

- To specify a secure-site certificate, see "Replacing the Default Secure-site Certificate" on page 3-78.

### Command Attributes

#### *HTTPS Settings*

- **HTTPS Status** – Allows you to enable/disable the HTTPS server feature on the switch. (Default: Enabled)
- **Change HTTPS Port Number** – Specifies the UDP port number used for HTTPS connection to the switch's web interface. (Default: Port 443)

#### *Copy HTTPS Certificate*

For more information on this function, see "Replacing the Default Secure-site Certificate" on page 3-78.

### 3 Configuring the Switch

**Web** – Click Security, HTTPS Settings. Enable HTTPS and specify the port number, then click Apply.

#### HTTPS Settings

HTTPS Status	<input checked="" type="checkbox"/> Enabled
Change HTTPS Port Number (1-65535)	443

#### Copy HTTPS Certificate

TFTP Server IP Address	0.0.0.0
Source Certificate File Name	
Source Private File Name	
Private Password	

Figure 3-46 HTTPS Settings

**CLI** – This example enables the HTTP secure server and modifies the port number.

```
Console(config)#ip http secure-server 4-124
Console(config)#ip http secure-port 443 4-125
Console(config)#
```

### Replacing the Default Secure-site Certificate

When you log onto the web interface using HTTPS (for secure access), a Secure Sockets Layer (SSL) certificate appears for the switch. By default, the certificate that Netscape and Internet Explorer display will be associated with a warning that the site is not recognized as a secure site. This is because the certificate has not been signed by an approved certification authority. If you want this warning to be replaced by a message confirming that the connection to the switch is secure, you must obtain a unique certificate and a private key and password from a recognized certification authority.

**Caution:** For maximum security, we recommend you obtain a unique Secure Sockets Layer certificate at the earliest opportunity. This is because the default certificate for the switch is not unique to the hardware you have purchased.

When you have obtained these, place them on your TFTP server and transfer them to the switch to replace the default (unrecognized) certificate with an authorized one.

### Command Attributes

- **TFTP Server IP Address** – IP address of TFTP server which contains the certificate file.
- **Source Certificate File Name** – Name of certificate file stored on the TFTP server.
- **Source Private File Name** – Name of private key file stored on the TFTP server.

- **Private Password** – Password stored in the private key file. This password is used to verify authorization for certificate use, and is verified when downloading the certificate to the switch.

**Web** – Click Security, HTTPS Settings. Fill in the TFTP server, certificate and private file name details, then click Copy Certificate.

### HTTPS Settings

HTTPS Status	<input checked="" type="checkbox"/> Enabled
Change HTTPS Port Number (1-65535)	443

### Copy HTTPS Certificate

TFTP Server IP Address	0.0.0.0
Source Certificate File Name	
Source Private File Name	
Private Password	

Figure 3-47 HTTPS Settings

**CLI** – This example copies the certificate file from the designated TFTP server.

```

Console#copy tftp https-certificate                                     4-35
TFTP server ip address: <server ip-address>
Source certificate file name: <certificate file name>
Source private file name: <private key file name>
Private password: <password for private key>

```

**Note:** The switch must be reset for the new certificate to be activated. To reset the switch, See “Resetting the System” on page 3-34 or type: `Console#reload`

## Configuring the Secure Shell

The Berkeley-standard includes remote access tools originally designed for Unix systems. Some of these tools have also been implemented for Microsoft Windows and other environments. These tools, including commands such as *rlogin* (remote login), *rsh* (remote shell), and *rcp* (remote copy), are not secure from hostile attacks.

The Secure Shell (SSH) includes server/client applications intended as a secure replacement for the older Berkeley remote access tools. SSH can also provide remote management access to this switch as a secure replacement for Telnet. When the client contacts the switch via the SSH protocol, the switch generates a public-key that the client uses along with a local user name and password for access authentication. SSH also encrypts all data transfers passing between the switch and SSH-enabled management station clients, and ensures that data traveling over the network arrives unaltered.

### 3 Configuring the Switch

- Notes:**
1. You need to install an SSH client on the management station to access the switch for management via the SSH protocol.
  2. The switch supports both SSH Version 1.5 and 2.0 clients.

#### Command Usage

The SSH server on this switch supports both password and public key authentication. If password authentication is specified by the SSH client, then the password can be authenticated either locally or via a RADIUS or TACACS+ remote authentication server, as specified on the **Authentication Settings** page (page 3-59). If public key authentication is specified by the client, then you must configure authentication keys on both the client and the switch as described in the following section. Note that regardless of whether you use public key or password authentication, you still have to generate authentication keys on the switch (SSH Host Key Settings) and enable the SSH server (Authentication Settings).

To use the SSH server, complete these steps:

1. *Generate a Host Key Pair* – On the SSH Host Key Settings page, create a host public/private key pair.
2. *Provide Host Public Key to Clients* – Many SSH client programs automatically import the host public key during the initial connection setup with the switch. Otherwise, you need to manually create a known hosts file on the management station and place the host public key in it. An entry for a public key in the known hosts file would appear similar to the following example:  

```
10.1.0.54 1024 35 15684995401867669259333946775054617325313674890836547254
15020245593199868544358361651999923329781766065830956 10825913212890233
76546801726272571413428762941301196195566782 59566410486957427888146206
519417467729848654686157177393901647793559423035774130980227370877945452
4083971752646358058176716709574804776117
```
3. *Import Client's Public Key to the Switch* – Use the **copy ftp public-key** command (page 4-35) to copy a file containing the public key for all the SSH client's granted management access to the switch. (Note that these clients must be configured locally on the switch via the User Accounts page as described on page 3-58.) The clients are subsequently authenticated using these keys. The current firmware only accepts public key files based on standard UNIX format as shown in the following example for an RSA Version 1 key:  

```
1024 35 1341081685609893921040944920155425347631641921872958921143173880
055536161631051775940838686311092912322268285192543746031009371877211996
963178136627741416898513204911720483033925432410163799759237144901193800
609025394840848271781943722884025331159521348610229029789827213532671316
29432532818915045306393916643 steve@192.168.1.19
```
4. *Set the Optional Parameters* – On the SSH Settings page, configure the optional parameters, including the authentication timeout, the number of retries, and the server key size.
5. *Enable SSH Service* – On the SSH Settings page, enable the SSH server on the switch.

6. *Authentication* – One of the following authentication methods is employed:

*Password Authentication (for SSH v1.5 or V2 Clients)*

- a. The client sends its password to the server.
- b. The switch compares the client's password to those stored in memory.
- c. If a match is found, the connection is allowed.

**Note:** To use SSH with only password authentication, the host public key must still be given to the client, either during initial connection or manually entered into the known host file. However, you do not need to configure the client's keys.

*Public Key Authentication* – When an SSH client attempts to contact the switch, the SSH server uses the host key pair to negotiate a session key and encryption method. Only clients that have a private key corresponding to the public keys stored on the switch can access it. The following exchanges take place during this process:

*Authenticating SSH v1.5 Clients*

- a. The client sends its RSA public key to the switch.
- b. The switch compares the client's public key to those stored in memory.
- c. If a match is found, the switch uses its secret key to generate a random 256-bit string as a challenge, encrypts this string with the user's public key, and sends it to the client.
- d. The client uses its private key to decrypt the challenge string, computes the MD5 checksum, and sends the checksum back to the switch.
- e. The switch compares the checksum sent from the client against that computed for the original string it sent. If the two checksums match, this means that the client's private key corresponds to an authorized public key, and the client is authenticated.

*Authenticating SSH v2 Clients*

- a. The client first queries the switch to determine if DSA public key authentication using a preferred algorithm is acceptable.
- b. If the specified algorithm is supported by the switch, it notifies the client to proceed with the authentication process. Otherwise, it rejects the request.
- c. The client sends a signature generated using the private key to the switch.
- d. When the server receives this message, it checks whether the supplied key is acceptable for authentication, and if so, it then checks whether the signature is correct. If both checks succeed, the client is authenticated.

**Note:** The SSH server supports up to four client sessions. The maximum number of client sessions includes both current Telnet sessions and SSH sessions.

## Generating the Host Key Pair

A host public/private key pair is used to provide secure communications between an SSH client and the switch. After generating this key pair, you must provide the host public key to SSH clients and import the client's public key to the switch as described in the preceding section (Command Usage).

### Field Attributes

- **Public-Key of Host-Key** – The public key for the host.
  - RSA (Version 1): The first field indicates the size of the host key (e.g., 1024), the second field is the encoded public exponent (e.g., 65537), and the last string is the encoded modulus.
  - DSA (Version 2): The first field indicates that the encryption method used by SSH is based on the Digital Signature Standard (DSS). The last string is the encoded modulus.
- **Host-Key Type** – The key type used to generate the host key pair (i.e., public and private keys). (Range: RSA (Version 1), DSA (Version 2), Both; Default: RSA)  
The SSH server uses RSA or DSA for key exchange when the client first establishes a connection with the switch, and then negotiates with the client to select either DES (56-bit) or 3DES (168-bit) for data encryption.  
**Note:** The switch uses only RSA Version 1 for SSHv1.5 clients and DSA Version 2 for SSHv2 clients.
- **Save Host-Key from Memory to Flash** – Saves the host key from RAM (i.e., volatile memory) to flash memory. Otherwise, the host key pair is stored to RAM by default. Note that you must select this item prior to generating the host-key pair.
- **Generate** – This button is used to generate the host key pair. Note that you must first generate the host key pair before you can enable the SSH server on the SSH Server Settings page.
- **Clear** – This button clears the host key from both volatile memory (RAM) and non-volatile memory (Flash).



**Web** – Click Security, SSH, Host-Key Settings. Select the host-key type from the drop-down box, select the option to save the host key from memory to flash (if required) prior to generating the key, and then click Generate.

**SSH Host-Key Settings**

**Public Key of Host Key**

RSA  
 1024 65537  
 1309178972674789616152111712764979196296211551642422768028072510384048338276358290698941935742287566  
 1853076228099531413921379002210394737439417368512447371756369962704297907054627111321882467751081589  
 04315863193489542002094633406761281150405946811464259257326509438403478583707539552641233928004845007  
 811621891

DSA  
 ssh-dss  
 AAAAB3NzaC1kc3MAAACBAjBVdKEZjKlWEEBw3AK1Fz72nOP8vPo8BdqF2eZeNxl7PQ/W4hYv/W427x1AwJ1/dEO4io8fhOdeHEUbb  
 kXO0EEdqU9/1uvvHmd+AEHksSnoZDrLWuyHjDowHDGpKvVSwVcZk1jz1FrQm6KtaC1c3ODUbovP0zcl1d+dJ3j3DC4tXqIAAAAFQCY  
 PELS=2E3SO3+P32+SzpbFA+cQAAAIAARYPgej1/ZfBrVhC9H/XuIV4pHEDY18fcrzrE1c3eBaLeE53gcH0uQrvPLGH+ZC1VX1d5  
 8VYvYKHANFGFnTKOGcGnhVOMj3hsEsgRqRqK17nWt2Ock4zERB0twpP5vCQaret3b1Ud1/eB2q7oyvnrUkk0Xv1QbWFP801pJX5op  
 QuAAAIB8HK3JwMaSpMCT36DxZH14sqQVbu7Gv5GVuxM6zaY9Z2HP5uPvV155wWencheCaRpGQJ11WVHEmtcgeFzrAw5G30Y41AR  
 qQcKc9p1vL4eVuxhRdx902H1WkjhNSHPVH4Cw2FLHpzBBnPL3MHqrvFYjNYBxJ8aqVQZK61knaGRQ==

Host-Key Type:

Save Host-Key from Memory to Flash

Figure 3-48 SSH Host-Key Settings

**CLI** – This example generates a host-key pair using both the RSA and DSA algorithms, stores the keys to flash memory, and then displays the host's public keys.

```

Console#ip ssh crypto host-key generate                                4-129
Console#ip ssh save host-key                                         4-129
Console#show public-key host                                         4-129
Host:
RSA:
1024 65537 127250922544926402131336514546131189679055192360076028653006761
82409690947448320102524878965977592168322225584652387791546479807396314033
86925793105105765212243052807865885485789272602937866089236841423275912127
60325919683697053439336438445223335188287173896894511729290510813919642025
190932104328579045764891
DSA:
ssh-dss AAAAB3NzaC1kc3MAAACBAN6zWtIqCqDb3869jYVX1ME1sHL0EcE/Re6h1asfEthIwmj
hLY400jqJZpcEQUgCfYlum0Y2uoLka+Py9ieGWQ8f2gobUZKIIICuKg6vjO9XTs7XXc055fzkBi
KviDa+2OrIz6UK+6vFOgVUDFedlnixYTVo+h5v8r0ea2rpnO6DkZAAAAFQCNzn/x17dwpW8RrV
DQnSww4Qk+6QAAAEIAptkGeB6B5hwagH4gUOCY6i1TmrmSiJgfw09OqRPUMbCAkCC+uzxatOo7
drnIzypMx+Sx5RUDMGGKS+9ywsalCwQHeFY5ilc3LDCNBueeLykZzVS+RS+azTKIk/zrJh8GLG
Nq375R55yRxFvmcGIn/Q7IphPqyJ3o9MK8LFDfmJEAAACAL8A6tESiswP2OFqX7Vg0EbZVDSOI
RTMFy3iUxtvGyQA0VSY67Mfc3lMtggPRUOYXDiwIBp5NXgicLc5z7VqbmRm28mWc5a//f8TUAg
PNWkV6W0hqmsHQdotVzDr1e+XKNTZj0uTwWfj05Ktycdn4MdoTHgrbl/DMDAfjnte8MZZS=
Console#
  
```

### Importing User Public Keys

A user's Public Key must be uploaded to the switch in order for the user to be able to log in using the public key authentication mechanism. If the user's public key does not exist on the switch, SSH will revert to the interactive password authentication mechanism to complete authentication.

#### Field Attributes

- **Public-Key of user** – The RSA and DSA public keys for the selected user.
  - RSA: The first field indicates the size of the host key (e.g., 1024), the second field is the encoded public exponent (e.g., 37), and the last string is the encoded modulus.
  - DSA: The first field indicates that SSH version 2 was used to create the key. The second field contains the key comment. The third string is the encoded modulus, and the last field is a comment denoting the end of the key.
- **User Name** – This drop-down box selects the user who's public key you wish to manage. Note that you must first create users on the User Accounts page (See "Configuring User Accounts" on page 3-58).
- **Public-Key Type** – The type of public key to upload.
  - RSA: The switch accepts a RSA version 1 encrypted public key.
  - DSA: The switch accepts a DSA version 2 encrypted public key.

The SSH server uses RSA or DSA for key exchange when the client first establishes a connection with the switch, and then negotiates with the client to select either DES (56-bit) or 3DES (168-bit) for data encryption.

The switch uses only RSA Version 1 for SSHv1.5 clients and DSA Version 2 for SSHv2 clients.
- **TFTP Server IP Address** – The IP address of the TFTP server that contains the public key file you wish to import. (Default: 0.0.0.0)
- **Source File Name** – The public key file to upload.
- **Copy Public Key** – Initiates the public key TFTP import process. If you are replacing an outdated public key file, it is not necessary to first delete the original key from the switch. The import process will overwrite the existing key.
- **Delete** – Deletes a selected RSA or DSA public key that has already been imported to the switch.

**Web** – Click Security, SSH, SSH User Public-Key Settings. Select the user name and the public-key type from the respective drop-down boxes, input the TFTP server IP address and the public key source file name, and then click Copy Public Key.

### SSH User Public-Key Settings

---

**Public-Key of admin**

RSA	<pre>1024 37 15488667554109960024267390807617186388095398459745454682506695100729617 432742713690050559162406811957940871622607863478068220149868579047506234519480 679939485042653504179153032795337422103356695026441903823445835730888234728896 908428216654290313159376526152793878682985398204661434741300230997984816260718 2657 rsa-key-20071106</pre>
DSA	<pre>----- BEGIN SSH2 PUBLIC KEY ----- Comment: "dsa-key-20071105" AAAAB3NzaC1kc3MAAACAEqN nwpAVz82Z3zFif0KGF846S5m5useW8rQp8DBv1IQ/ sLYRuoCtW/+hllaUu2F9Ps6D5gJdKjyEPKRutJ v1rAwq1YZ61/fat9OGpM3oaqM f6UiVUK4gEsaq8T6UqrGslDcXWYvmbI02+R/rowN43kwEJCfmpBXel hU962AA2G0A AAAVAkXtZo+MjTVzRJ+9mFTFIUpawm7HAAAAGCINbc04jTWcdMKS1oQTA+WnC ehI sd8j5MpDc3VccySMaFzcPgxT+N79WVxWNJQaS8I9TTY3EDg9VfCooLZDrmYX67M V3pIJej57D sNjLnCHpaGE/OKfkAhvRzlufS4f4wAzOYCBNxb6XY6Vew8Pi7Wri L/Xrm4AQ0t4wSijEAAAAGDNcK KEpZw16wW7E9EmbQp5s5gu9ICVCqMz5r76EyEzc 9ulYxy54GHMtyBwLTTtH6lBxEgD6cOnkCW+i eRye9fiJfs7u4QdL9NZb+WLZvcU Xm6E1vUc70OpelDFxbfhQawgGFxx7rzs85D75ffnEqbLW2mKAp ehuQrHYbPZOnX ----- END SSH2 PUBLIC KEY -----</pre>

User Name	<input type="text" value="admin"/>
Public-Key Type	<input type="text" value="RSA"/>
TFTP Server IP Address	<input type="text" value="0.0.0.0"/>
Source File Name	<input type="text"/>

**Figure 3-49 SSH User Public-Key Settings**

## 3 Configuring the Switch

**CLI** – This example imports an SSHv2 DSA public key for the user admin and then displays admin's imported public keys. Note that public key authentication through SSH is only supported for users configured locally on the switch.

```
Console#copy tftp public-key 4-35
TFTP server IP address: 192.168.1.254
Choose public key type:
 1. RSA:  2. DSA: <1-2>: 2
Source file name: admin-ssh2-dsa-pub.key
Username: admin
TFTP Download
Success.
Write to FLASH Programming.
Success.

Console#show public-key user admin 4-135
admin:
RSA:
1024 37 154886675541099600242673908076171863880953984597454546825066951007
29617437427136900505591624068119579408716226078634780682201498685790475062
34519480679939485042653504179153032795337422103356695026441903823445835730
88823472889690842821665429031315937652815279387868298539820466143474130023
09979848162607182657 rsa-key-20071106

DSA:
---- BEGIN SSH2 PUBLIC KEY ----
Comment: "dsa-key-20071105"
AAAAB3NzaC1kc3MAAA
CAeqNwvpAVz82Z3zFif0KGF846S5m5useW8rQp8DBv1IQ/sLYRuoCtW/+h11IaUu2F9Ps6D5gJ
dKjyEPKRutJv1rAwq1YZ61/fat9OGpM3oaqMf6UiVUK4gEsaq8T6UqrGsIDcXWYvmbI02+R/
owN43kwEJCfmpBXelhu962AA2G0AAAAVAkxtZo+MjTVzRj+9mFTFIUpawm7HAAAAGCINbco4jT
WcdMKS1oQTA+WnCehlsd8j5MpDc3VccySMaFzcPgxt+N79WVxwWNJQaS819TfY3EDg9VfCooLZD
rn/yX67MV3p/IJej57DsNjLnChpaGE/OKfkaHvjRzluF54f4wAzOYCBNxb6XY6Vew8Pi7Wri
L/Xrm4AQ0t4wSjJEAAAAGDncKKEpZw16ww7E9EmbQp5s5gu9lCVCqMz5r76EYezc
9uIYvxy54GHMtyBwLTITh61bxEGD6cOnkCW+1eRye9fiJfs7u4QdL9Nzb+WLVzvcUXm6E1vUc70
Ope1DFxbfhQawgGFvxv7rzv85D75ffNEqbLW2mKapehuQrHYbPzOnX
---- END SSH2 PUBLIC KEY ----

Console#
```

## Configuring the SSH Server

The SSH server includes basic settings for authentication.

### Field Attributes

- **SSH Server Status** – Allows you to enable/disable the SSH server on the switch. (Default: Disabled)
- **Version** – The Secure Shell version number. Version 2.0 is displayed, but the switch supports management access via either SSH Version 1.5 or 2.0 clients.
- **SSH Authentication Timeout** – Specifies the time interval in seconds that the SSH server waits for a response from a client during an authentication attempt. (Range: 1-120 seconds; Default: 120 seconds)
- **SSH Authentication Retries** – Specifies the number of authentication attempts that a client is allowed before authentication fails and the client has to restart the authentication process. (Range: 1-5 times; Default: 3)

- **SSH Server-Key Size** – Specifies the SSH server key size.  
(Range: 512-896 bits; Default:768)
  - The server key is a private key that is never shared outside the switch.
  - The host key is shared with the SSH client, and is fixed at 1024 bits.

**Web** – Click Security, SSH, Settings. Enable SSH and adjust the authentication parameters as required, then click Apply. Note that you must first generate the host key pair on the SSH Host-Key Settings page before you can enable the SSH server.

### SSH Server Settings

---

SSH Server Status	<input type="checkbox"/> Enabled
Version	2.0
SSH Authentication Timeout (1-120)	<input type="text" value="120"/> seconds
SSH Authentication Retries (1-5)	<input type="text" value="3"/>
SSH Server-Key Size (512-896)	<input type="text" value="768"/>

Figure 3-50 SSH Server Settings

**CLI** – This example enables SSH, sets the authentication parameters, and displays the current configuration. It shows that the administrator has made a connection via SSH, and then disables this connection.

```

Console(config)#ip ssh server                               4-129
Console(config)#ip ssh timeout 100                        4-130
Console(config)#ip ssh authentication-retries 5           4-130
Console(config)#ip ssh server-key size 512                4-131
Console(config)#end
Console#show ip ssh                                       4-133
SSH Enabled - version 2.0
Negotiation timeout: 120 secs; Authentication retries: 5
Server key size: 512 bits
Console#show ssh                                          4-134
Connection Version State           Username Encryption
0          2.0    Session-Started    admin   ctos aes128-cbc-hmac-md5
          stoc aes128-cbc-hmac-md5
Console#disconnect 0                                     4-48
Console#
  
```

## Configuring 802.1X Port Authentication

Network switches can provide open and easy access to network resources by simply attaching a client PC. Although this automatic configuration and access is a desirable feature, it also allows unauthorized personnel to easily intrude and possibly gain access to sensitive network data.

The IEEE 802.1X (dot1X) standard defines a port-based access control procedure that prevents unauthorized access to a network by requiring users to first submit credentials for authentication. Access to all switch ports in a network can be centrally controlled from a server, which means that authorized users can use the same credentials for authentication from any point within the network.

This switch uses the Extensible Authentication Protocol over LANs (EAPOL) to exchange authentication protocol messages with the client, and a remote RADIUS authentication server to verify user identity and access rights. When a client (i.e., Supplicant) connects to a switch port, the switch (i.e.,

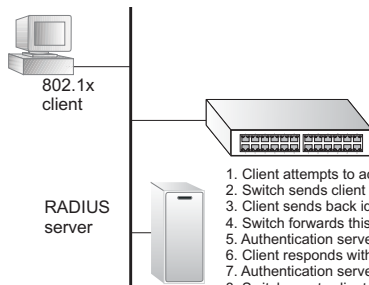

1. Client attempts to access a switch port.
2. Switch sends client an identity request.
3. Client sends back identity information.
4. Switch forwards this to authentication server.
5. Authentication server challenges client.
6. Client responds with proper credentials.
7. Authentication server approves access.
8. Switch grants client access to this port.

Authenticator) responds with an EAPOL identity request. The client provides its identity (such as a user name) in an EAPOL response to the switch, which it forwards to the RADIUS server. The RADIUS server verifies the client identity and sends an access challenge back to the client. The EAP packet from the RADIUS server contains not only the challenge, but the authentication method to be used. The client can reject the authentication method and request another, depending on the configuration of the client software and the RADIUS server. The encryption method used to pass authentication messages can be MD5 (Message-Digest 5), TLS (Transport Layer Security), PEAP (Protected Extensible Authentication Protocol), or TTLS (Tunneled Transport Layer Security). The client responds to the appropriate method with its credentials, such as a password or certificate. The RADIUS server verifies the client credentials and responds with an accept or reject packet. If authentication is successful, the switch allows the client to access the network. Otherwise, non-EAP traffic on the port is blocked or assigned to a guest VLAN based on the “intrusion-action” setting. In “multi-host” mode, only one host connected to a port needs to pass authentication for all other hosts to be granted network access. Similarly, a port can become unauthorized for all hosts if one attached host fails re-authentication or sends an EAPOL logoff message.

The operation of 802.1X on the switch requires the following:

- The switch must have an IP address assigned.
- RADIUS authentication must be enabled on the switch and the IP address of the RADIUS server specified.
- 802.1X must be enabled globally for the switch.

- Each switch port that will be used must be set to dot1X “Auto” mode.
- Each client that needs to be authenticated must have dot1X client software installed and properly configured.
- The RADIUS server and 802.1X client support EAP. (The switch only supports EAPOL in order to pass the EAP packets from the server to the client.)
- The RADIUS server and client also have to support the same EAP authentication type – MD5, PEAP, TLS, or TTLS. (Some clients have native support in the operating system, otherwise the dot1x client must support the required authentication method.)

## Displaying 802.1X Global Settings

The 802.1X protocol provides client authentication.

### Command Attributes

**802.1X System Authentication Control** – The global setting for 802.1X.

**Web** – Click Security, 802.1X, Information.



Figure 3-51 802.1X Global Information

**CLI** – This example shows the default global setting for 802.1X.

```

Console#show dot1x 4-142
Global 802.1X Parameters
  system-auth-control: enable

802.1X Port Summary

Port Name   Status           Operation Mode   Mode                Authorized
1/1         disabled        Single-Host     ForceAuthorized     n/a
1/2         disabled        Single-Host     ForceAuthorized     n/a
:
:

802.1X Port Details

802.1X is disabled on port 1/1
:
:
802.1X is disabled on port 1/28
Console#
  
```

### 3 Configuring the Switch

#### Configuring 802.1X Global Settings

The 802.1X protocol provides port authentication. The 802.1X protocol must be enabled globally for the switch system before port settings are active.

##### Command Attributes

**802.1X System Authentication Control** – Sets the global setting for 802.1X. (Default: Disabled)

**Web** – Select Security, 802.1X, Configuration. Enable 802.1X globally for the switch, and click Apply.



The screenshot shows a web interface titled "802.1X Configuration". Below the title is a horizontal line. Underneath, there is a form element consisting of a text box containing "802.1X System Authentication Control" and a checked checkbox followed by the text "Enabled".

Figure 3-52 802.1X Global Configuration

**CLI** – This example enables 802.1X globally for the switch.

```
Console(config)#dot1x system-auth-control 4-136
Console(config)#
```

#### Configuring Port Settings for 802.1X

When 802.1X is enabled, you need to configure the parameters for the authentication process that runs between the client and the switch (i.e., authenticator), as well as the client identity lookup process that runs between the switch and authentication server. These parameters are described in this section.

##### Command Attributes

- **Port** – Port number.
- **Status** – Indicates if authentication is enabled or disabled on the port. (Default: Disabled)
- **Operation Mode** – Allows single or multiple hosts (clients) to connect to an 802.1X-authorized port. (Options: Single-Host, Multi-Host; Default: Single-Host)
- **Max Count** – The maximum number of hosts that can connect to a port when the Multi-Host operation mode is selected. (Range: 1-1024; Default: 5)
- **Mode** – Sets the authentication mode to one of the following options:
  - **Auto** – Requires a dot1x-aware client to be authorized by the authentication server. Clients that are not dot1x-aware will be denied access.
  - **Force-Authorized** – Forces the port to grant access to all clients, either dot1x-aware or otherwise. (This is the default setting.)
  - **Force-Unauthorized** – Forces the port to deny access to all clients, either dot1x-aware or otherwise.



- **Re-authentication** – Sets the client to be re-authenticated after the interval specified by the Re-authentication Period. Re-authentication can be used to detect if a new device is plugged into a switch port. (Default: Disabled)
- **Max-Request** – Sets the maximum number of times the switch port will retransmit an EAP request packet to the client before it times out the authentication session. (Range: 1-10; Default 2)
- **Quiet Period** – Sets the time that a switch port waits after the Max Request Count has been exceeded before attempting to acquire a new client. (Range: 1-65535 seconds; Default: 60 seconds)
- **Re-authentication Period** – Sets the time period after which a connected client must be re-authenticated. (Range: 1-65535 seconds; Default: 3600 seconds)
- **Tx Period** – Sets the time period during an authentication session that the switch waits before re-transmitting an EAP packet. (Range: 1-65535; Default: 30 seconds)
- **Intrusion Action** – Sets the port's response to a failed authentication.
  - Block Traffic – Blocks all non-EAP traffic on the port. (This is the default setting.)
  - Guest VLAN – All traffic for the port is assigned to a guest VLAN. The guest VLAN must be separately configured (See “Creating VLANs” on page 3-189) and mapped on each port (see “Configuring MAC Authentication for Ports” on page 3-104).
- **Authorized** – Displays the 802.1X authorization status of connected clients.
  - **Yes** – Connected client is authorized.
  - **No** – Connected client is not authorized.
  - *Blank* – Displays nothing when dot1x is disabled on a port.
- **Supplicant** – Indicates the MAC address of a connected client.
- **Trunk** – Indicates if the port is configured as a trunk port.

**Web** – Click Security, 802.1X, Port Configuration. Modify the parameters required, and click Apply.

802.1X Port Configuration													
Port	Status	Operation Mode	Max Count (1-1024)	Mode	Re-authen	Max-Req	Quiet/Period	Re-authen/Period	Tx Period	Intrusion Action	Authorized	Supplicant	Trunk
1	Disabled	Single-Host	5	Force-Authorized	<input type="checkbox"/> Enable	2	60	3600	30	Block Traffic	Yes	00:00:00:00:00:00	
2	Enabled	Single-Host	5	Auto	<input checked="" type="checkbox"/> Enable	2	60	3600	30	Guest VLAN		00:00:00:00:00:00	
3	Disabled	Single-Host	5	Force-Unauthenticated	<input type="checkbox"/> Enable	2	60	3600	30	Block Traffic		00:00:00:00:00:00	
4	Disabled	Single-Host	5	Force-Authorized	<input type="checkbox"/> Enable	2	60	3600	30	Block Traffic		00:00:00:00:00:00	
5	Disabled	Single-Host	5	Force-Authorized	<input type="checkbox"/> Enable	2	60	3600	30	Block Traffic		00:00:00:00:00:00	
6	Disabled	Single-Host	5	Force-Authorized	<input type="checkbox"/> Enable	2	60	3600	30	Block Traffic		00:00:00:00:00:00	
7	Disabled	Single-Host	5	Force-Authorized	<input type="checkbox"/> Enable	2	60	3600	30	Block Traffic		00:00:00:00:00:00	
8	Disabled	Single-Host	5	Force-Authorized	<input type="checkbox"/> Enable	2	60	3600	30	Block Traffic		00:00:00:00:00:00	
9	Disabled	Single-Host	5	Force-Authorized	<input type="checkbox"/> Enable	2	60	3600	30	Block Traffic		00:00:00:00:00:00	
10	Disabled	Single-Host	5	Force-Authorized	<input type="checkbox"/> Enable	2	60	3600	30	Block Traffic		00:00:00:00:00:00	
11	Disabled	Single-Host	5	Force-Authorized	<input type="checkbox"/> Enable	2	60	3600	30	Block Traffic		00:00:00:00:00:00	
12	Disabled	Single-Host	5	Force-Authorized	<input type="checkbox"/> Enable	2	60	3600	30	Block Traffic		00:00:00:00:00:00	
13	Disabled	Single-Host	5	Force-Authorized	<input type="checkbox"/> Enable	2	60	3600	30	Block Traffic		00:00:00:00:00:00	
14	Disabled	Single-Host	5	Force-Authorized	<input type="checkbox"/> Enable	2	60	3600	30	Block Traffic		00:00:00:00:00:00	
15	Disabled	Single-Host	5	Force-Authorized	<input type="checkbox"/> Enable	2	60	3600	30	Block Traffic		00:00:00:00:00:00	
16	Disabled	Single-Host	5	Force-Authorized	<input type="checkbox"/> Enable	2	60	3600	30	Block Traffic		00:00:00:00:00:00	
17	Disabled	Single-Host	5	Force-Authorized	<input type="checkbox"/> Enable	2	60	3600	30	Block Traffic		00:00:00:00:00:00	
18	Disabled	Single-Host	5	Force-Authorized	<input type="checkbox"/> Enable	2	60	3600	30	Block Traffic		00:00:00:00:00:00	
19	Disabled	Single-Host	5	Force-Authorized	<input type="checkbox"/> Enable	2	60	3600	30	Block Traffic		00:00:00:00:00:00	
20	Disabled	Single-Host	5	Force-Authorized	<input type="checkbox"/> Enable	2	60	3600	30	Block Traffic		00:00:00:00:00:00	
21	Disabled	Single-Host	5	Force-Authorized	<input type="checkbox"/> Enable	2	60	3600	30	Block Traffic		00:00:00:00:00:00	
22	Disabled	Single-Host	5	Force-Authorized	<input type="checkbox"/> Enable	2	60	3600	30	Block Traffic		00:00:00:00:00:00	

Figure 3-53 802.1X Port Configuration

### 3 Configuring the Switch

**CLI** – This example sets the 802.1X parameters on port 2. For a description of the additional fields displayed in this example, see “show dot1x” on page 4-142.

```
Console(config)#interface ethernet 1/2 4-187
Console(config-if)#dot1x port-control auto 4-137
Console(config-if)#dot1x re-authentication 4-139
Console(config-if)#dot1x max-req 5 4-137
Console(config-if)#dot1x timeout quiet-period 30 4-140
Console(config-if)#dot1x timeout re-authperiod 1800 4-140
Console(config-if)#dot1x timeout tx-period 40 4-141
Console(config-if)#dot1x intrusion-action guest-vlan 4-141
Console(config-if)#exit
Console(config)#exit
Console#show dot1x 4-142
Global 802.1X Parameters
  system-auth-control: enable

802.1X Port Summary

Port Name   Status           Operation Mode   Mode              Authorized
-----
1/1         disabled        Single-Host     ForceAuthorized   n/a
1/2         enabled         Single-Host     auto              yes
:
:
1/28        disabled        Single-Host     ForceAuthorized   n/a

802.1X Port Details

802.1X is disabled on port 1/1

802.1X is enabled on port 1/2
  reauth-enabled: Enable
  reauth-period: 1800
  quiet-period: 30
  tx-period: 40
  supplicant-timeout: 30
  server-timeout: 10
  reauth-max: 2
  max-req: 5
Status Authorized
Operation mode Single-Host
Max count 5
Port-control Auto
Supplicant 00-12-CF-49-5e-dc
Current Identifier 3
Intrusion action Guest VLAN

Authenticator State Machine
State Authenticated
Reauth Count 0

Backend State Machine
State Idle
Request Count 0
Identifier(Server) 2

Reauthentication State Machine
State Initialize
:
:
802.1X is disabled on port 1/28
Console#
```

## Displaying 802.1X Statistics

This switch can display statistics for dot1x protocol exchanges for any port.

**Table 3-7 802.1X Statistics**

Parameter	Description
Rx EAPOL Start	The number of EAPOL Start frames that have been received by this Authenticator.
Rx EAPOL Logoff	The number of EAPOL Logoff frames that have been received by this Authenticator.
Rx EAPOL Invalid	The number of EAPOL frames that have been received by this Authenticator in which the frame type is not recognized.
Rx EAPOL Total	The number of valid EAPOL frames of any type that have been received by this Authenticator.
Rx EAP Resp/Id	The number of EAP Resp/Id frames that have been received by this Authenticator.
Rx EAP Resp/Oth	The number of valid EAP Response frames (other than Resp/Id frames) that have been received by this Authenticator.
Rx EAP LenError	The number of EAPOL frames that have been received by this Authenticator in which the Packet Body Length field is invalid.
Rx Last EAPOLVer	The protocol version number carried in the most recently received EAPOL frame.
Rx Last EAPOLSrc	The source MAC address carried in the most recently received EAPOL frame.
Tx EAPOL Total	The number of EAPOL frames of any type that have been transmitted by this Authenticator.
Tx EAP Req/Id	The number of EAP Req/Id frames that have been transmitted by this Authenticator.
Tx EAP Req/Oth	The number of EAP Request frames (other than Rq/Id frames) that have been transmitted by this Authenticator.

### 3 Configuring the Switch

**Web** – Select Security, 802.1X, Statistics. Select the required port and then click Query. Click Refresh to update the statistics.

## 802.1X Statistics

Port: 4

Query

Rx EAPOL Start	0	Rx EAP LenError	0
Rx EAPOL Logoff	0	Rx Last EAPOLVer	0
Rx EAPOL Invalid	0	Rx Last EAPOLSrc	00-00-00-00-00-00
Rx EAPOL Total	0	Tx EAPOL Total	0
Rx EAP Resp/Id	0	Tx EAP Req/Id	0
Rx EAP Resp/Oth	0	Tx EAP Req/Oth	0

Refresh

Figure 3-54 Displaying 802.1X Port Statistics

**CLI** – This example displays the 802.1X statistics for port 4.

```
Console#show dot1x statistics interface ethernet 1/4 4-142

Eth 1/4
Rx: EAPOL      EAPOL      EAPOL      EAPOL      EAP      EAP      EAP
   Start      Logoff      Invalid      Total      Resp/Id  Resp/Oth LenError
      2          0          0          1007      672      0         0

   Last      Last
EAPOLVer    EAPOLSrc
      1      00-12-CF-94-34-DE

Tx: EAPOL      EAP      EAP
   Total      Req/Id  Req/Oth
   2017      1005   0
Console#
```

## Filtering IP Addresses for Management Access

You can create a list of up to 16 IP addresses or IP address groups that are allowed management access to the switch through the web interface, SNMP, or Telnet.

### Command Usage

- The management interfaces are open to all IP addresses by default. Once you add an entry to a filter list, access to that interface is restricted to the specified addresses.
- If anyone tries to access a management interface on the switch from an invalid address, the switch will reject the connection, enter an event message in the system log, and send a trap message to the trap manager.

- IP address can be configured for SNMP, web and Telnet access respectively. Each of these groups can include up to five different sets of addresses, either individual addresses or address ranges.
- When entering addresses for the same group (i.e., SNMP, web or Telnet), the switch will not accept overlapping address ranges. When entering addresses for different groups, the switch will accept overlapping address ranges.
- You cannot delete an individual address from a specified range. You must delete the entire range, and reenter the addresses.
- You can delete an address range just by specifying the start address, or by specifying both the start address and end address.

### Command Attributes

- **Web IP Filter** – Configures IP address(es) for the web group.
- **SNMP IP Filter** – Configures IP address(es) for the SNMP group.
- **Telnet IP Filter** – Configures IP address(es) for the Telnet group.
- **IP Filter List** – IP address which are allowed management access to this interface.
- **Start IP Address** – A single IP address, or the starting address of a range.
- **End IP Address** – The end address of a range.
- **Add/Remove Filtering Entry** – Adds/removes an IP address from the list.

**Web** – Click Security, IP Filter. Enter the IP addresses or range of addresses that are allowed management access to an interface, and click Add Web IP Filtering Entry to update the filter list.

Telnet IP Filter List	
	192.168.1.19 192.168.1.19
	192.168.1.25 192.168.1.30

Start IP Address

End IP Address

Figure 3-55 Creating an IP Filter List

### 3 Configuring the Switch

**CLI** – This example allows SNMP access for a specific client.

```
Console(config)#management snmp-client 10.1.2.3 4-145
Console(config)#end
Console#show management all-client
Management IP Filter
  HTTP-Client:
    Start IP address  End IP address
-----
SNMP-Client:
  Start IP address  End IP address
-----
1. 10.1.2.3        10.1.2.3
TELNET-Client:
  Start IP address  End IP address
-----
Console#
```

## General Security Measures

This switch supports many methods of segregating traffic for clients attached to each of the data ports, and for ensuring that only authorized clients gain access to the network. Private VLANs and port-based authentication using IEEE 802.1X are commonly used for these purposes. In addition to these methods, several other options of providing client security are supported by this switch. These include port-based authentication, which can be configured for network client access by specifying a fixed set of MAC addresses. The addresses assigned to DHCP clients can also be carefully controlled using static or dynamic bindings with the IP Source Guard and DHCP Snooping commands.

This switch provides client security using the following options:

- Private VLANs – Provide port-based security and isolation between ports within the assigned VLAN. (See “Private VLANs” on page 3-204.)
- Port Security – Configure secure addresses for individual ports.
- 802.1X – Use IEEE 802.1X port authentication to control access to specific ports. (See “Configuring 802.1X Port Authentication” on page 3-88.)
- Web Authentication - Allows stations to authenticate and access the network in situations where 802.1X or Network Access authentication methods are infeasible or impractical.
- Network Access - Configures MAC authentication and dynamic VLAN assignment.
- ACL - Access Control Lists provide packet filtering for IP frames (based on address, protocol, Layer 4 protocol port number or TCP control code) or any frames (based on MAC address or Ethernet type).
- DHCP Snooping – Filters IP traffic on insecure ports for which the source address cannot be identified via DHCP snooping nor static source bindings. (See “DHCP Snooping” on page 3-116.)

- IP Source Guard – Filters untrusted DHCP messages on unsecure ports by building and maintaining a DHCP snooping binding table. (See “IP Source Guard” on page 3-123.)

**Note:** The priority of execution for the filtering commands is Port Security, Port Authentication, Network Access, Web Authentication, Access Control Lists, IP Source Guard, and then DHCP Snooping.

## Configuring Port Security

Port security is a feature that allows you to configure a switch port with one or more device MAC addresses that are authorized to access the network through that port.

When port security is enabled on a port, the switch stops learning new MAC addresses on the specified port when it has reached a configured maximum number. Only incoming traffic with source addresses already stored in the dynamic or static address table will be authorized to access the network through that port. If a device with an unauthorized MAC address attempts to use the switch port, the intrusion will be detected and the switch can automatically take action by disabling the port and sending a trap message.

To use port security, specify a maximum number of addresses to allow on the port and then let the switch dynamically learn the <source MAC address, VLAN> pair for frames received on the port. Note that you can also manually add secure addresses to the port using the Static Address Table (page 3-158). When the port has reached the maximum number of MAC addresses the selected port will stop learning. The MAC addresses already in the address table will be retained and will not age out. Any other device that attempts to use the port will be prevented from accessing the switch.

### Command Usage

- A secure port has the following restrictions:
  - It cannot be used as a member of a static or dynamic trunk.
  - It should not be connected to a network interconnection device.
- The default maximum number of MAC addresses allowed on a secure port is zero. You must configure a maximum address count from 1 - 1024 for the port to allow access.
- If a port is disabled (shut down) due to a security violation, it must be manually re-enabled from the Port/Port Configuration page (page 3-129).

### Command Attributes

- **Port** – Port number.
- **Name** – Descriptive text (page 4-188).
- **Action** – Indicates the action to be taken when a port security violation is detected:
  - **None:** No action should be taken. (This is the default.)
  - **Trap:** Send an SNMP trap message.
  - **Shutdown:** Disable the port.
  - **Trap and Shutdown:** Send an SNMP trap message and disable the port.

### 3 Configuring the Switch

- **Security Status** – Enables or disables port security on the port. (Default: Disabled)
- **Max MAC Count** – The maximum number of MAC addresses that can be learned on a port. (Range: 0 - 1024, where 0 means disabled)
- **Trunk** – Trunk number if port is a member (page 3-133 and 3-134).

**Web** – Click Security, Port Security. Set the action to take when an invalid address is detected on a port, mark the checkbox in the Status column to enable security for a port, set the maximum number of MAC addresses allowed on a port, and click Apply.

**Configuration:**

Port	Name	Action	Security Status	Max MAC Count (0-1024)	Trunk
1		None	<input type="checkbox"/> Enabled	0	
2		None	<input type="checkbox"/> Enabled	0	
3		None	<input type="checkbox"/> Enabled	0	
4		None	<input type="checkbox"/> Enabled	0	
5		Trap and Shutdown	<input checked="" type="checkbox"/> Enabled	20	
6		None	<input type="checkbox"/> Enabled	0	

Figure 3-56 Configuring Port Security

**CLI** – This example selects the target port, sets the port security action to send a trap and disable the port, sets the maximum MAC addresses allowed on the port, and then enables port security for the port.

```
Console(config)#interface ethernet 1/5
Console(config-if)#port security action trap-and-shutdown           4-148
Console(config-if)#port security max-mac-count 20                  4-148
Console(config-if)#port security                                   4-148
Console(config-if)#
```

## Web Authentication

Web authentication allows stations to authenticate and access the network in situations where 802.1X or Network Access authentication are infeasible or impractical. The web authentication feature allows unauthenticated hosts to request and receive a DHCP assigned IP address and perform DNS queries. All other traffic, except for HTTP protocol traffic, is blocked. The switch intercepts HTTP protocol traffic and redirects it to a switch-generated web page that facilitates username and password authentication via RADIUS. Once authentication is successful, the web browser is forwarded on to the originally requested web page. Successful authentication is valid for all hosts connected to the port.

- Notes:**
1. RADIUS authentication must be activated and configured properly for the web authentication feature to work properly. (See “Configuring Local/Remote Logon Authentication” on page 3-59)
  2. Web authentication cannot be configured on trunk ports.



## Configuring Web Authentication

Web authentication is configured on a per-port basis, however there are four configurable parameters that apply globally to all ports on the switch.

### Command Attributes

- **System Authentication Control** – Enables Web Authentication for the switch. (Default: Disabled)
- **Session Timeout** – Configures how long an authenticated session stays active before it must be re-authenticated. (Range: 300-3600 seconds; Default: 3600 seconds)
- **Quiet Period** – Configures how long a host must wait to attempt authentication again after it has exceeded the maximum allowable failed login attempts. (Range: 1-180 seconds; Default: 60 seconds)
- **Login Attempts** – Configures the number of times a supplicant may attempt and fail authentication before it must wait the configured quiet period. (Range: 1-3 attempts; Default: 3 attempts)

**Web** – Click Security, Web Authentication, Configuration.

Web Authentication Configuration	
System Authentication Control	<input type="checkbox"/> Enabled
Session Timeout(300-3600)	3600 seconds
Quiet Period(1-180)	60 seconds
Login Attempts(1-3)	3

Figure 3-57 Web Authentication Configuration

**CLI** – This example globally enables the system authentication control, configures the session timeout, quiet period and login attempts, and displays the configured global parameters.

```

Console(config)#mac-authentication reauth-time 3000      4-154
Console(config)#web-auth system-auth-control            4-159
Console(config)#web-auth session-timeout 1800          4-159
Console(config)#web-auth quiet-period 20               4-158
Console(config)#web-auth login-attempts 2              4-158
Console(config)#end
Console#show web-auth                                  4-161

Global Web-Auth Parameters

  System Auth Control      : Enabled
  Session Timeout         : 1800
  Quiet Period            : 20
  Max Login Attempts      : 2
Console#

```

### 3 Configuring the Switch

#### Configuring Web Authentication for Ports

Web authentication is configured on a per-port basis. The following parameters are associated with each port.

##### Command Attributes

- **Port** – Indicates the port being configured
- **Status** – Configures the web authentication status for the port.
- **Authenticated Host Counts** – Indicates how many authenticated hosts are connected to the port.

**Web** – Click Security, Web Authentication, Port Configuration. Set the status box to enabled for any port that requires web authentication, and click Apply.

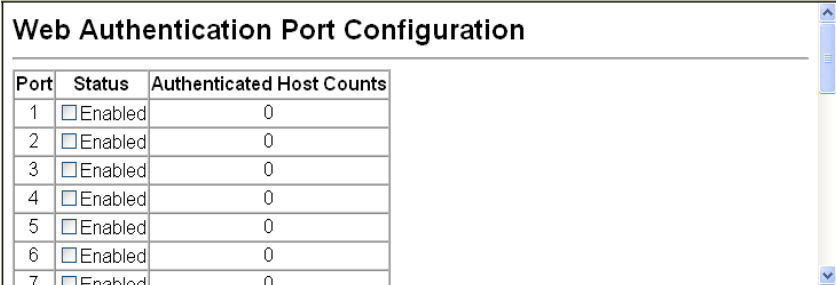

Port	Status	Authenticated Host Counts
1	<input type="checkbox"/> Enabled	0
2	<input type="checkbox"/> Enabled	0
3	<input type="checkbox"/> Enabled	0
4	<input type="checkbox"/> Enabled	0
5	<input type="checkbox"/> Enabled	0
6	<input type="checkbox"/> Enabled	0
7	<input type="checkbox"/> Enabled	0

Figure 3-58 Web Authentication Port Configuration

**CLI** – This example enables web authentication for ethernet port 1/5 and displays a summary of web authentication parameters.

```
Console(config)#interface ethernet 1/5          4-187
Console(config-if)#web-auth                    4-160
Console(config-if)#end
Console#show web-auth summary                  4-163

Global Web-Auth Parameters

  System Auth Control      : Enabled
Port      Status          Authenticated Host Count
-----
1/ 1      Disabled        0
1/ 2      Enabled         0
1/ 3      Disabled        0
1/ 4      Disabled        0
1/ 5      Enabled         0
1/ 6      Disabled        0
1/ 7      Disabled        0
1/ 8      Disabled        0
1/ 9      Disabled        0
:
```

## Displaying Web Authentication Port Information

This switch can display web authentication information for all ports and connected hosts.

### Command Attributes

- **Interface** – Indicates the ethernet port to query.
- **IP Address** – Indicates the IP address of each connected host.
- **Status** – Indicates the authorization status of each connected host.
- **Remaining Session Time (seconds)** – Indicates the remaining time until the current authorization session for the host expires.

**Web** – Click Security, Web Authentication, Port Information.

### Web Authentication Port Information

---

Interface Port 1 ▼

IP Address	Status	Remaining Session Time (seconds)

Figure 3-59 Web Authentication Port Information

**CLI** – This example displays web authentication parameters for port 1/5.

```

Console#show web-auth interface ethernet 1/5                               4-162
Web Auth Status      : Enabled

Host Summary

IP address           Web-Auth-State  Remaining-Session-Time
-----
1.1.1.1              Authenticated   295
1.1.1.2              Authenticated   111
Console#
  
```

## Re-authenticating Web Authenticated Ports

The switch allows an administrator to manually force re-authentication of any web-authenticated host connected to any port.

### Command Attributes

- **Interface** – Indicates the ethernet port to query.
- **Host IP** – Indicates the IP address of the host selected for re-authentication.
- **Re-authenticate** – Ends all web authentication sessions connected to the port and forces the users to re-authenticate.

### 3 Configuring the Switch

**Web** – Click Security, Web Authentication, Re-authentication.

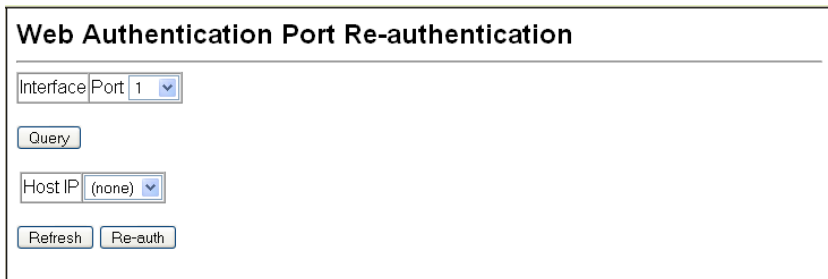

The screenshot shows a web interface for configuring port re-authentication. At the top, the title is "Web Authentication Port Re-authentication". Below the title, there is a dropdown menu labeled "Interface" with "Port 1" selected. Underneath is a "Query" button. Below that is another dropdown menu labeled "Host IP" with "(none)" selected. At the bottom of the form are two buttons: "Refresh" and "Re-auth".

**Figure 3-60 Web Authentication Port Re-authentication**

**CLI** – This example forces the re-authentication of all hosts connected to port 1/5.

```
Console#web-auth re-authenticate interface ethernet 1/5          4-160
Console#
```

## Network Access (MAC Address Authentication)

Some devices connected to switch ports may not be able to support 802.1X authentication due to hardware or software limitations. This is often true for devices such as network printers, IP phones, and some wireless access points. The switch enables network access from these devices to be controlled by authenticating device MAC addresses with a central RADIUS server.

- Notes:**
1. RADIUS authentication must be activated and configured properly for the MAC Address authentication feature to work properly. (See “RADIUS Client” on page 4-105.)
  2. MAC authentication cannot be configured on trunk ports.

### Command Usage

- Network Access authentication controls access to the network by authenticating the MAC address of each host that attempts to connect to a switch port. Traffic received from a specific MAC address is forwarded by the switch only if the source MAC address is successfully authenticated by a central RADIUS server. While authentication for a MAC address is in progress, all traffic is blocked until authentication is completed. On successful authentication, the RADIUS server may optionally assign VLAN settings for the switch port.
- When enabled on a port interface, the authentication process sends a Password Authentication Protocol (PAP) request to a configured RADIUS server. The user name and password are both equal to the MAC address being authenticated. On the RADIUS server, PAP username and passwords must be configured in the MAC address format XX-XX-XX-XX-XX-XX (all in upper case).
- Authenticated MAC addresses are stored as dynamic entries in the switch secure MAC address table and are removed when the aging time expires. The maximum number of secure MAC addresses supported for the switch system is 1024.

- Configured static MAC addresses are added to the secure address table when seen on a switch port. Static addresses are treated as authenticated without sending a request to a RADIUS server.
- When port status changes to down, all MAC addresses are cleared from the secure MAC address table. Static VLAN assignments are not restored.
- The RADIUS server may optionally return a VLAN identifier list to be applied to the switch port. The following attributes need to be configured on the RADIUS server.
  - **Tunnel-Type** = VLAN
  - **Tunnel-Medium-Type** = 802
  - **Tunnel-Private-Group-ID** = 1u,2t [*VLAN ID list*]

The VLAN identifier list is carried in the RADIUS “Tunnel-Private-Group-ID” attribute. The VLAN list can contain multiple VLAN identifiers in the format “1u,2t,3u” where “u” indicates an untagged VLAN and “t” a tagged VLAN.

### Configuring the MAC Authentication Reauthentication Time

MAC address authentication is configured on a per-port basis, however there are two configurable parameters that apply globally to all ports on the switch.

#### Command Attributes

- **Authenticated Age** – The secure MAC address table aging time. This parameter setting is the same as switch MAC address table aging time and is only configurable from the Address Table, Aging Time web page (see page 3-160). (Default: 300 seconds)
- **MAC Authentication Reauthentication Time** – Sets the time period after which a connected MAC address must be reauthenticated. When the reauthentication time expires for a secure MAC address, it is reauthenticated with the RADIUS server. During the reauthentication process traffic through the port remains unaffected. (Default: 1800 seconds; Range: 120-1000000 seconds)
- **MAC Address Aging** – Enables MAC address aging for the secure MAC address table. (Default: Disabled)

**Web** – Click Security, Network Access, Configuration.

### Network Access Configuration

Authenticated Age	300 seconds
MAC Authentication Reauthentication Time (120-1000000; default:1800)	<input type="text" value="3000"/> seconds
MAC Address Aging	<input checked="" type="checkbox"/> Enabled

Figure 3-61 Network Access Configuration

### 3 Configuring the Switch

**CLI** – This example sets and displays the reauthentication time.

```
Console(config)#mac-authentication reauth-time 3000          4-154
Console(config)#network-access aging                         4-150
Console(config)#exit
Console#show network-access interface ethernet 1/1          4-156
Global secure port information
Reauthentication Time           : 3000
-----
Port : 1/1
MAC Authentication              : Disabled
MAC Authentication Intrusion action : Block traffic
MAC Authentication Maximum MAC Counts : 1024
Maximum MAC Counts             : 2048
Dynamic VLAN Assignment        : Enabled
Guest VLAN                     : Disabled
Console#
```

### Configuring MAC Authentication for Ports

Configures MAC authentication on switch ports, including setting the maximum MAC count, applying a MAC address filter, and enabling dynamic VLAN assignment.

#### Command Attributes

- **Mode** – Enables MAC authentication on a port. (Default: None)
- **Maximum MAC Count** – Sets the maximum number of MAC addresses that can be authenticated on a port. The maximum number of MAC addresses per port is 2048, and the maximum number of secure MAC addresses supported for the switch system is 1024. When the limit is reached, all new MAC addresses are treated as authentication failed. (Default: 2048; Range: 1 to 2048)
- **Guest VLAN** – Specifies the VLAN to be assigned to the port when MAC Authentication or 802.1X Port Authentication fails. The VLAN must already be created and active. (Default: Disabled; Range: 1 to 4094)

The VLAN must already be created and active (see “Creating VLANs” on page 3-189). Also, when used with 802.1X authentication, intrusion action must be set for “Guest VLAN” (see “Configuring Port Settings for 802.1X” on page 3-90).

- **Dynamic VLAN** – Enables dynamic VLAN assignment for an authenticated port. When enabled, any VLAN identifiers returned by the RADIUS server are applied to the port, providing the VLANs have already been created on the switch. (GVRP is not used to create the VLANs.) (Default: Enabled)

The VLAN settings specified by the first authenticated MAC address are implemented for a port. Other authenticated MAC addresses on the port must have the same VLAN configuration, or they are treated as authentication failures.

If dynamic VLAN assignment is enabled on a port and the RADIUS server returns no VLAN configuration, the authentication is still treated as a success, and the host assigned to the default untagged VLAN.

When the dynamic VLAN assignment status is changed on a port, all authenticated addresses are cleared from the secure MAC address table.

**Note:** MAC authentication cannot be configured on trunk ports. Ports configured as trunk members are indicated on the Network Access Port Configuration page in the “Trunk” column.

**Web** – Click Security, Network Access, Port Configuration.

Network Access Port Configuration					
Port	Mode	Maximum MAC Count (1-2048)	Guest VLAN (1-4094, 0:Disabled)	Dynamic VLAN	Trunk
1	MAC Authentication	2048	0	<input checked="" type="checkbox"/> Enabled	
2	MAC Authentication	2048	0	<input type="checkbox"/> Enabled	
3	MAC Authentication	2048	0	<input checked="" type="checkbox"/> Enabled	
4	None	2048	0	<input type="checkbox"/> Enabled	
5	None	2048	0	<input type="checkbox"/> Enabled	
6	None	2048	0	<input type="checkbox"/> Enabled	
7	None	2048	0	<input type="checkbox"/> Enabled	
8	None	2048	0	<input type="checkbox"/> Enabled	
9	None	2048	0	<input type="checkbox"/> Enabled	

**Figure 3-62 Network Access Port Configuration**

**CLI** – This example configures MAC authentication for port 1.

```

Console(config)#interface ethernet 1/1
Console(config-if)#network-access mode mac-authentication           4-151
Console(config-if)#network-access max-mac-count 10                 4-152
Console(config-if)#mac-authentication max-mac-count 24            4-154
Console(config-if)#network-access dynamic-vlan                     4-152
Console(config-if)#network-access guest-vlan                       4-153
Console(config-if)#end
Console#show network-access interface ethernet 1/1
Global secure port information
Reauthentication Time           : 1800
-----
Port : 1/1
MAC Authentication              : Enabled
MAC Authentication Intrusion action : Block traffic
MAC Authentication Maximum MAC Counts : 1024
Maximum MAC Counts              : 2048
Dynamic VLAN Assignment        : Enabled
Guest VLAN                      : Enabled
Console#

```

#### Displaying Secure MAC Address Information

Authenticated MAC addresses are stored in the secure MAC address table. Information on the secure MAC entries can be displayed and selected entries removed from the table.

#### Command Attributes

- **Network Access MAC Address Count** – The number of MAC addresses currently in the secure MAC address table.
- **Query By** – Specifies parameters to use in the MAC address query.
  - **Port** – Specifies a port interface.
  - **MAC Address** – Specifies a single MAC address information.
  - **Attribute** – Displays static or dynamic addresses.
  - **Address Table Sort Key** – Sorts the information displayed based on MAC address or port interface.
- **Unit/Port** – The port interface associated with a secure MAC address.
- **MAC Address** – The authenticated MAC address.
- **RADIUS Server** – The IP address of the RADIUS server that authenticated the MAC address.
- **Time** – The time when the MAC address was last authenticated.
- **Attribute** – Indicates a static or dynamic address.
- **Remove** – Click the Remove button to remove selected MAC addresses from the secure MAC address table.

**Web** – Click Security, Network Access, MAC Address Information. Restrict the displayed addresses by port, MAC Address, or attribute, then select the method of sorting the displayed addresses. Click Query.

### Network Access MAC Address Information

---

Network Access MAC Address Count	0
----------------------------------	---

<b>Query by:</b>	
<input type="checkbox"/> Port	1 <span style="font-size: small;">▼</span>
<input type="checkbox"/> MAC Address	
<input type="checkbox"/> Attribute	Static <span style="font-size: small;">▼</span>
Address Table Sort Key	Address <span style="font-size: small;">▼</span>

Query

	Unit/port	MAC Address	RADIUS Server	Time	Attribute
--	-----------	-------------	---------------	------	-----------

Remove

Figure 3-63 Network Access MAC Address Information



**CLI** – This example displays all entries currently in the secure MAC address table.

```

Console#show network-access mac-address-table 4-156
-----
Port  MAC-Address      RADIUS-Server  Attribute  Time
-----
1/1   00-00-01-02-03-04  172.155.120.17 Static      00d06h32m50s
1/1   00-00-01-02-03-05  172.155.120.17 Dynamic     00d06h33m20s
1/1   00-00-01-02-03-06  172.155.120.17 Static      00d06h35m10s
1/3   00-00-01-02-03-07  172.155.120.17 Dynamic     00d06h34m20s
Console#

```

## MAC Authentication

Each port's MAC authentication settings are configured independently.

### Configuring MAC authentication parameters for ports

Use the MAC Authentication Port Configuration page to designate MAC authentication maximum MAC counts and the intrusion action for each port.

#### Command Attributes

- **Port** – Indicates the port being configured.
- **Status** – Indicates whether MAC Authentication is enabled or disabled for the port. See “Configuring MAC Authentication for Ports” on page 3-104. The following parameters are unavailable for modification if MAC Authentication is not enabled for the port.
- **Max MAC Count** – The maximum allowed amount of MAC authenticated MAC addresses on the port. (Default: 1024; Range: 1-1024)
- **Intrusion Action** – The switch can respond in two ways to an intrusion.
  - **Block Traffic** – All traffic for the unauthenticated host is blocked.
  - **Pass Traffic** – All traffic for the unauthenticated host is allowed.
- **Trunk** – Indicates if the port is a trunk member.

### 3 Configuring the Switch

**Web** – Click Security, MAC Authentication. Modify the Maximum MAC Count and Intrusion Action. Click Apply.

Port	Status	Maximum MAC Count (1-1024)	Intrusion Action	Trunk
1	Disabled	1024	Block traffic	
2	Enabled	1024	Block traffic	
3	Disabled	1024	Block traffic	
4	Disabled	1024	Block traffic	
5	Disabled	1024	Block traffic	
6	Disabled	1024	Block traffic	
7	Disabled	1024	Block traffic	
8	Disabled	1024	Block traffic	
9	Disabled	1024	Block traffic	
10	Disabled	1024	Block traffic	

Figure 3-64 MAC Authentication Port Configuration

**CLI** – This example configures the maximum MAC count to 32 and sets the intrusion action to block all traffic for port 1.

```
Console(config)#interface ethernet 1/1 4-187
Console(config-if)#mac-authentication max-mac-count 24 4-155
Console(config-if)#mac-authentication intrusion-action block-traffic4-154
Console(config-if)#
```

## Access Control Lists

Access Control Lists (ACL) provide packet filtering for IP frames (based on address, protocol, Layer 4 protocol port number or TCP control code) or any frames (based on MAC address or Ethernet type). To filter incoming packets, first create an access list, add the required rules, and then bind the list to a specific port.

### Configuring Access Control Lists –

An ACL is a sequential list of permit or deny conditions that apply to IP addresses, MAC addresses, or other more specific criteria. This switch tests ingress or egress packets against the conditions in an ACL one by one. A packet will be accepted as soon as it matches a permit rule, or dropped as soon as it matches a deny rule. If no rules match for a list of all permit rules, the packet is dropped; and if no rules match for a list of all deny rules, the packet is accepted.

### Command Usage

The following restrictions apply to ACLs:

- The maximum number of ACLs is 64.
- Each ACL can have up to 32 rules. However, due to resource restrictions, the average number of rules bound to the ports should not exceed 20.

The order in which active ACLs are checked is as follows:

1. User-defined rules in the Egress IP ACL for egress ports.
2. User-defined rules in the Ingress IP ACL for ingress ports.
3. Explicit default rule (permit any any) in the ingress IP ACL for ingress ports.
4. If no explicit rule is matched, the implicit default is permit all.

## Setting the ACL Name and Type

Use the ACL Configuration page to designate the name and type of an ACL.

### Command Attributes

- **Name** – Name of the ACL. (Maximum length: 15 characters)
- **Type** – There are three filtering modes:
  - **Standard** – IP ACL mode that filters packets based on the source IP address.
  - **Extended** – IP ACL mode that filters packets based on source or destination IP address, as well as protocol type and protocol port number. If the “TCP” protocol is specified, then you can also filter packets based on the TCP control code.
  - **MAC** – MAC ACL mode that filters packets based on the source or destination MAC address and the Ethernet frame type (RFC 1060).

**Web** – Select Security, ACL, Configuration. Enter an ACL name in the Name field, select the list type (IP Standard, IP Extended, or MAC), and click Add to open the configuration page for the new list.

### ACL Configuration

---

Type	Name	Remove	Edit
------	------	--------	------

Name	<input type="text"/>
Type	Standard ▾

Figure 3-65 Selecting ACL Type

**CLI** – This example creates a standard IP ACL named david.

```
Console(config)#access-list ip standard david
Console(config-std-acl)#
```

4-176

### 3 Configuring the Switch

## Configuring a Standard IP ACL

### Command Attributes

- **Action** – An ACL can contain any combination of permit or deny rules.
- **Address Type** – Specifies the source IP address. Use “Any” to include all possible addresses, “Host” to specify a specific host address in the Address field, or “IP” to specify a range of addresses with the Address and SubMask fields. (Options: Any, Host, IP; Default: Any)
- **IP Address** – Source IP address.
- **Subnet Mask** – A subnet mask containing four integers from 0 to 255, each separated by a period. The mask uses 1 bits to indicate “match” and 0 bits to indicate “ignore.” The mask is bitwise ANDed with the specified source IP address, and compared with the address for each IP packet entering the port(s) to which this ACL has been assigned.

**Web** – Specify the action (i.e., Permit or Deny). Select the address type (Any, Host, or IP). If you select “Host,” enter a specific address. If you select “IP,” enter a subnet address and the mask for an address range. Then click Add.

### Standard ACL

---

**Name: Standard ACL**

Action	IP Address	Subnet Mask	Remove
--------	------------	-------------	--------

Action	Permit		
Address Type	Any		
IP Address	0.0.0.0		
Subnet Mask	0.0.0.0		

Add

Figure 3-66 Configuring Standard IP ACLs

**CLI** – This example configures one permit rule for the specific address 10.1.1.21 and another rule for the address range 168.92.16.x – 168.92.31.x using a bitmask.

```
Console(config-std-acl)#permit host 10.1.1.21 4-177
Console(config-std-acl)#permit 168.92.16.0 255.255.240.0
Console(config-std-acl)#
```

## Configuring an Extended IP ACL

### Command Attributes

- **Action** – An ACL can contain any combination of permit or deny rules.
- **Source/Destination Address Type** – Specifies the source or destination IP address. Use “Any” to include all possible addresses, “Host” to specify a specific host address in the Address field, or “IP” to specify a range of addresses with the Address and SubMask fields. (Options: Any, Host, IP; Default: Any)
- **Source/Destination IP Address** – Source or destination IP address.
- **Source/Destination Subnet Mask** – Subnet mask for source or destination address. (See the description for Subnet Mask on page 3-110.)
- **Service Type** – Packet priority settings based on the following criteria:
  - **TOS** – Type of Service level. (Range: 0-15)
  - **Precedence** – IP precedence level. (Range: 0-7)
  - **DSCP** – DSCP priority level. (Range: 0-63)
- **Protocol** – Specifies the protocol type to match as TCP, UDP or Others, where others indicates a specific protocol number (0-255). (Options: TCP, UDP, Others; Default: TCP)
- **Source/Destination Port** – Source/destination port number for the specified protocol type. (Range: 0-65535)
- **Source/Destination Port Bitmask** – Decimal number representing the port bits to match. (Range: 0-65535)
- **Control Code** – Decimal number (representing a bit string) that specifies flag bits in byte 14 of the TCP header. (Range: 0-63)
- **Control Code Bit Mask** – Decimal number representing the code bits to match. The control bitmask is a decimal number (for an equivalent binary bit mask) that is applied to the control code. Enter a decimal number, where the equivalent binary bit “1” means to match a bit and “0” means to ignore a bit. The following bits may be specified:
  - 1 (fin) – Finish
  - 2 (syn) – Synchronize
  - 4 (rst) – Reset
  - 8 (psh) – Push
  - 16 (ack) – Acknowledgement
  - 32 (urg) – Urgent pointerFor example, use the code value and mask below to catch packets with the following flags set:
  - SYN flag valid, use control-code 2, control bitmask 2
  - Both SYN and ACK valid, use control-code 18, control bitmask 18
  - SYN valid and ACK invalid, use control-code 2, control bitmask 18

### 3 Configuring the Switch

**Web** – Specify the action (i.e., Permit or Deny). Specify the source and/or destination addresses. Select the address type (Any, Host, or IP). If you select “Host,” enter a specific address. If you select “IP,” enter a subnet address and the mask for an address range. Set any other required criteria, such as service type, protocol type, or TCP control code. Then click Add.

**Extended ACL**

Name: b

Action	Source IP Address	Source Subnet Mask	Destination IP Address	Destination Subnet Mask	TOS	Precedence	DSCP	Protocol	Source Port	Source Port Bit Mask	Destination Port	Destination Port Bit Mask	Control Code	Control Code Bit Mask	Remove
Permit	10.7.1.0	255.255.255.255	Any	Any	Any	Any	Any	6	Any	Any	Any	Any	Any	Any	Remove
Permit	192.168.1.0	255.255.255.0	Any	Any	Any	Any	Any	6	Any	Any	80	65535	Any	Any	Remove

Action	<input type="text" value="Permit"/>
Source Address Type	<input type="text" value="Any"/>
Source IP Address	<input type="text" value="0.0.0.0"/>
Source Subnet Mask	<input type="text" value="0.0.0.0"/>
Destination Address Type	<input type="text" value="Any"/>
Destination IP Address	<input type="text" value="0.0.0.0"/>
Destination Subnet Mask	<input type="text" value="0.0.0.0"/>
Service Type	<input checked="" type="radio"/> TOS (0-15): <input type="text"/> Precedence (0-7): <input type="text"/> <input type="radio"/> DSCP (0-63): <input type="text"/>
Protocol	<input checked="" type="radio"/> TCP (6) <input type="radio"/> UDP (17) <input type="radio"/> Others: <input type="text"/>
Source Port (0-65535)	<input type="text"/>
Source Port Bit Mask (0-65535)	<input type="text"/>
Destination Port (0-65535)	<input type="text"/>
Destination Port Bit Mask (0-65535)	<input type="text"/>
Control Code (0-63)	<input type="text"/>
Control Code Bit Mask (0-63)	<input type="text"/>

Figure 3-67 Configuring Extended IP ACLs

**CLI** – This example adds two rules:

- (1) Accept any incoming packets if the source address is in subnet 10.7.1.x. For example, if the rule is matched; i.e., the rule (10.7.1.0 & 255.255.255.0) equals the masked address (10.7.1.2 & 255.255.255.0), the packet passes through.
- (2) Allow TCP packets from class C addresses 192.168.1.0 to any destination address when set for destination TCP port 80 (i.e., HTTP).
3. Permit all TCP packets from class C addresses 192.168.1.0 with the TCP control code set to “SYN.”

```

Console(config-ext-acl)#permit 10.7.1.1 255.255.255.0 any 4-178
Console(config-ext-acl)#permit tcp 192.168.1.0 255.255.255.0 any
destination-port 80
Console(config-ext-acl)#permit tcp 192.168.1.0 255.255.255.0 any
control-flag 2 2
Console(config-std-acl)#

```

## Configuring a MAC ACL

### Command Attributes

- **Action** – An ACL can contain any combination of permit or deny rules.
- **Source/Destination Address Type** – Use “Any” to include all possible addresses, “Host” to indicate a specific MAC address, or “MAC” to specify an address range with the Address and Bitmask fields. (Options: Any, Host, MAC; Default: Any)
- **Source/Destination MAC Address** – Source or destination MAC address.
- **Source/Destination Bitmask** – Hexadecimal mask for source or destination MAC address.
- **CoS** – Class-of-Service value (Range: 0-7)
- **CoS Bitmask** – Class-of-Service bitmask. (Range: Range: 0-7)
- **VID** – VLAN ID. (Range: 1-4094)
- **VID Mask** – VLAN bitmask. (Range: 0-4095)
- **Ethernet Type** – This option can only be used to filter Ethernet II formatted packets. (Range: 600-fff hex.)

A detailed listing of Ethernet protocol types can be found in RFC 1060. A few of the more common types include 0800 (IP), 0806 (ARP), 8137 (IPX).

- **Ethernet Type Bitmask** – Protocol bitmask. (Range: 600-fff hex.)
- **Packet Format** – This attribute includes the following packet types:
  - **Any** – Any Ethernet packet type.
  - **Untagged-eth2** – Untagged Ethernet II packets.
  - **Untagged-802.3** – Untagged Ethernet 802.3 packets.
  - **Tagged-802.3** – Tagged Ethernet 802.3 packets.
  - **Tagged-802.3** – Tagged Ethernet 802.3 packets.

### 3 Configuring the Switch

**Web** – Specify the action (i.e., Permit or Deny). Specify the source and/or destination addresses. Select the address type (Any, Host, or MAC). If you select "Host," enter a specific address (e.g., 11-22-33-44-55-66). If you select "MAC," enter a base address and a hexadecimal bitmask for an address range. Set any other required criteria, such as VID, Ethernet type, or packet format. Then click Add.

**MAC ACL**

---

Name: c

Action	Source MAC Address	Source Bit Mask	Destination MAC Address	Destination Bit Mask	CoS	CoS Bit Mask	VID	VID Bit Mask	Ethernet Type	Ethernet Type Bit Mask	Packet Format	Remove
Permit	Any	Any	00-E0-29-94-34-DE	FF-FF-FF-FF-FF-FF	Any	Any	Any	Any	2048	FFFF	Any	<span style="color: red;">Remove</span>

Action	<input type="text" value="Permit"/>
Source Address Type	<input type="text" value="Any"/>
Source MAC Address	<input type="text" value="00-00-00-00-00-00"/>
Source Bit Mask	<input type="text" value="00-00-00-00-00-00"/>
Destination Address Type	<input type="text" value="Any"/>
Destination MAC Address	<input type="text" value="00-00-00-00-00-00"/>
Destination Bit Mask	<input type="text" value="00-00-00-00-00-00"/>
CoS	<input type="text" value=""/> (0-7, decimal value)
CoS Bit Mask	<input type="text" value=""/> (0-7, decimal value)
VID	<input type="text" value=""/> (1-4094, decimal value)
VID Bit Mask	<input type="text" value=""/> (0-4095, decimal value)
Ethernet Type	<input type="text" value=""/> (0000-FFFF, hexadecimal value)
Ethernet Type Bit Mask	<input type="text" value=""/> (0000-FFFF, hexadecimal value)
Packet Format	<input type="text" value="Any"/>

**Figure 3-68 Configuring MAC ACLs**

**CLI** – This example configures one permit rule for all source mac addresses to communicate with all destination mac addresses on VLAN 12, and another permit rule for source mac address to communicate with all destination mac addresses.

```

Console(config-mac-acl)#permit any any vid 12 4095
Console(config-mac-acl)#permit host 00-10-b5-e9-52-79 any
Console(config-mac-acl)#
    
```

4-183



## Binding a Port to an Access Control List

After configuring the Access Control Lists (ACL), you can bind the ports that need to filter traffic to the appropriate ACLs. You can assign one IP access list to any port.

### Command Usage

- Each ACL can have up to 100 rules.
- This switch supports ACLs for ingress filtering only.

### Command Attributes

- **Port** – Fixed port or SFP module. (Range: 1-28)
- **IP** – Specifies the IP ACL to bind to a port.
- **MAC** – Specifies the MAC ACL to bind to a port.
- **IN** – ACL for ingress packets.

**Web** – Click Security, ACL, Port Binding. Mark the Enable field for the port you want to bind to an ACL for ingress or egress traffic, select the required ACL from the drop-down list, then click Apply.

### ACL Port Binding

Port	IP		MAC		Trunk
	Enabled	IN	Enabled	IN	
1	<input checked="" type="checkbox"/>	Enabled david	<input type="checkbox"/>	Enabled jerry	
2	<input type="checkbox"/>	Enabled david	<input checked="" type="checkbox"/>	Enabled jerry	
3	<input type="checkbox"/>	Enabled david	<input type="checkbox"/>	Enabled jerry	
4	<input type="checkbox"/>	Enabled david	<input type="checkbox"/>	Enabled jerry	
5	<input type="checkbox"/>	Enabled david	<input type="checkbox"/>	Enabled jerry	

Figure 3-69 Configuring ACL Port Binding

**CLI** – This example assigns an IP access list to port 1, and an IP access list to port 3.

```

Console(config)#interface ethernet 1/1                                4-187
Console(config-if)#ip access-group david in                          4-180
Console(config-if)#exit
Console(config)#interface ethernet 1/3
Console(config-if)#ip access-group david in
Console(config-if)#

```

### DHCP Snooping

The addresses assigned to DHCP clients on unsecure ports can be carefully controlled using the dynamic bindings registered with DHCP Snooping (or using the static bindings configured with IP Source Guard). DHCP snooping allows a switch to protect a network from rogue DHCP servers or other devices which send port-related information to a DHCP server. This information can be useful in tracking an IP address back to a physical port.

#### Command Usage

- Network traffic may be disrupted when malicious DHCP messages are received from an outside source. DHCP snooping is used to filter DHCP messages received on a non-secure interface from outside the network or firewall. When DHCP snooping is enabled globally and enabled on a VLAN interface, DHCP messages received on an untrusted interface from a device not listed in the DHCP snooping table will be dropped.
- Table entries are only learned for trusted interfaces. An entry is added or removed dynamically to the DHCP snooping table when a client receives or releases an IP address from a DHCP server. Each entry includes a MAC address, IP address, lease time, VLAN identifier, and port identifier.
- The rate limit for the number of DHCP messages that can be processed by the switch is 100 packets per second. Any DHCP packets in excess of this limit are dropped.
- When DHCP snooping is enabled, DHCP messages entering an untrusted interface are filtered based upon dynamic entries learned via DHCP snooping.
- Filtering rules are implemented as follows:
  - If the global DHCP snooping is disabled, all DHCP packets are forwarded.
  - If DHCP snooping is enabled globally, and also enabled on the VLAN where the DHCP packet is received, all DHCP packets are forwarded for a *trusted* port. If the received packet is a DHCP ACK message, a dynamic DHCP snooping entry is also added to the binding table.
  - If DHCP snooping is enabled globally, and also enabled on the VLAN where the DHCP packet is received, but the port is *not trusted*, it is processed as follows:
    - \* If the DHCP packet is a reply packet from a DHCP server (including OFFER, ACK or NAK messages), the packet is dropped.
    - \* If the DHCP packet is from a client, such as a DECLINE or RELEASE message, the switch forwards the packet only if the corresponding entry is found in the binding table.
    - \* If the DHCP packet is from a client, such as a DISCOVER, REQUEST, INFORM, DECLINE or RELEASE message, the packet is forwarded if MAC address verification is disabled. However, if MAC address verification is enabled, then the packet will only be forwarded if the client's hardware address stored in the DHCP packet is the same as the source MAC address in the Ethernet header.
    - \* If the DHCP packet is not a recognizable type, it is dropped.

- If a DHCP packet from a client passes the filtering criteria above, it will only be forwarded to trusted ports in the same VLAN.
- If a DHCP packet is from server is received on a trusted port, it will be forwarded to both trusted and untrusted ports in the same VLAN.
- If the DHCP snooping is globally disabled, all dynamic bindings are removed from the binding table.
- *Additional considerations when the switch itself is a DHCP client* – The port(s) through which the switch submits a client request to the DHCP server must be configured as trusted. Note that the switch will not add a dynamic entry for itself to the binding table when it receives an ACK message from a DHCP server. Also, when the switch sends out DHCP client packets for itself, no filtering takes place. However, when the switch receives any messages from a DHCP server, any packets received from untrusted ports are dropped.

### Configuring DHCP Snooping

Use the DHCP Snooping Configuration page to enable DHCP Snooping globally on the switch, or to configure MAC Address Verification.

#### Command Attributes

- **DHCP Snooping Status** – Enables DHCP snooping globally. (Default: Disabled)
- **DHCP Snooping MAC-Address Verification** – Enables or disables MAC address verification. DHCP packets will be dropped if the source MAC address in the Ethernet header of the packet is not same as the client's hardware address in the DHCP packet.

**Web** – Click DHCP Snooping, Configuration. Select the required options and click Apply.

### DHCP Snooping Configuration

---

DHCP Snooping Status	<input type="checkbox"/> Enabled
DHCP Snooping MAC-Address Verification	<input checked="" type="checkbox"/> Enabled

Figure 3-70 DHCP Snooping Configuration

**CLI** – This example first enables DHCP Snooping, and then enables DHCP Snooping MAC-Address Verification.

```

Console(config)#ip dhcp snooping                               4-164
Console(config)#ip dhcp snooping verify mac-address           4-167
Console(config)#

```

### 3 Configuring the Switch

#### Configuring VLANs for DHCP Snooping

Enables DHCP snooping on the specified VLAN.

##### Command Usage

- When DHCP snooping is enabled globally on the switch, and enabled on the specified VLAN, DHCP packet filtering will be performed on any untrusted ports within the VLAN.
- When the DHCP snooping is globally disabled, DHCP snooping can still be configured for specific VLANs, but the changes will not take effect until DHCP snooping is globally re-enabled.
- When DHCP snooping is globally enabled, and DHCP snooping is then disabled on a VLAN, all dynamic bindings learned for this VLAN are removed from the binding table.

##### Command Attributes

- **VLAN ID** – ID of a configured VLAN. (Range: 1-4094)
- **DHCP Snooping Status** – Enables or disables DHCP snooping for the selected VLAN.

**Web** – Click DHCP Snooping, VLAN Configuration.

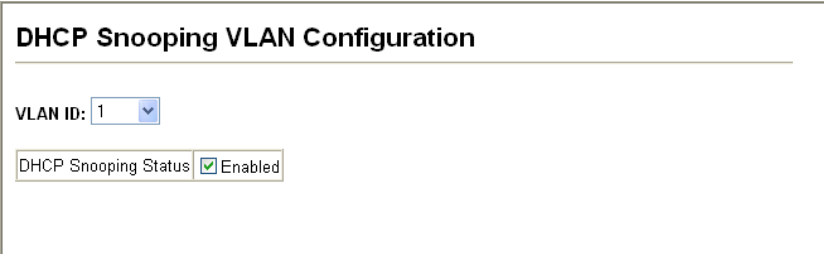

**DHCP Snooping VLAN Configuration**

---

VLAN ID: 1

DHCP Snooping Status  Enabled

Figure 3-71 DHCP Snooping VLAN Configuration

**CLI** – This example first enables DHCP Snooping for VLAN 1.

```
Console(config)#ip dhcp snooping vlan 1  
Console(config)#
```

4-165

#### Configuring the DHCP Snooping Information Option

DHCP provides a relay mechanism for sending information about the switch and its DHCP clients to the DHCP server. Known as DHCP Option 82, it allows compatible DHCP servers to use the information when assigning IP addresses, or to set other services or policies for clients. It is also an effective tool in preventing malicious network attacks from attached clients on DHCP services, such as IP Spoofing, Client Identifier Spoofing, MAC Address Spoofing, and Address Exhaustion.

## Command Usage

- DHCP Snooping (see page 3-117) must be enabled for Option 82 information to be inserted into request packets.
- When Option 82 is enabled, the requesting client (or an intermediate relay agent that has used the information fields to describe itself) can be identified in the DHCP request packets forwarded by the switch and in reply packets sent back from the DHCP server.
- When the DHCP Snooping Information Option is enabled, clients can be identified by the switch port to which they are connected rather than just their MAC address. DHCP client-server exchange messages are then forwarded directly between the server and client without having to flood them to the entire VLAN.
- If Option 82 is enabled on the switch, information about the switch itself may be included in any relayed request packet.
- In some cases, the switch may receive DHCP packets from a client that already includes DHCP Option 82 information. The switch can be configured to set the action policy for these packets. The switch can either drop the DHCP packets, keep the existing information, or replace it with the switch's relay information.

## Command Attributes

- **DHCP Snooping Information Option Status** – Enables or disables DHCP Option 82 information relay. (Default: Disabled)
- **DHCP Snooping Information Option Policy** – Sets the DHCP snooping information option policy for DHCP client packets that include Option 82 information.
  - **Drop** – Drops the client's request packet instead of relaying it.
  - **Keep** – Retains the Option 82 information in the client request, and forwards the packets to trusted ports.
  - **Replace** – Replaces the Option 82 information in the client's request with information about the relay agent itself, inserts the relay agent's address (when DHCP snooping is enabled), and forwards the packets to trusted ports. (This is the default policy.)

**Web** – Click DHCP Snooping, Information Option Configuration. Enable Option 82, and set the policy for handling request packets, then click Apply.

### DHCP Snooping Information Option Configuration

---

DHCP Snooping Information Option Status	<input type="checkbox"/> Enabled
DHCP Snooping Information Option Policy	Replace ▾

Figure 3-72 DHCP Snooping Information Option Configuration

### 3 Configuring the Switch

**CLI** – This example enables DHCP Snooping Information Option, and sets the policy as replace.

```
Console(config)#ip dhcp snooping information option          4-168
Console(config)#ip dhcp snooping information policy replace  4-169
Console(config)#exit
Console#show ip dhcp snooping                                4-170
Global DHCP Snooping status: disable
DHCP Snooping Information Option Status: disable
DHCP Snooping Information Policy: replace
DHCP Snooping is configured on the following VLANs:

Verify Source Mac-Address: enable
Interface              Trusted
-----              -
Eth 1/1                No
Eth 1/2                No
Eth 1/3                No
:
```

### Configuring Ports for DHCP Snooping

Configures switch ports as trusted or untrusted.

#### Command Usage

- A trusted interface is an interface that is configured to receive only messages from within the network. An untrusted interface is an interface that is configured to receive messages from outside the network or firewall.
- When DHCP snooping enabled both globally and on a VLAN, DHCP packet filtering will be performed on any untrusted ports within the VLAN.
- When an untrusted port is changed to a trusted port, all the dynamic DHCP snooping bindings associated with this port are removed.
- Set all ports connected to DHCP servers within the local network or firewall to trusted state. Set all other ports outside the local network or firewall to untrusted state.

### Command Attributes

- **Trust Status** – Enables or disables port as trusted.

**Web** – Click DHCP Snooping, Information Option Configuration.

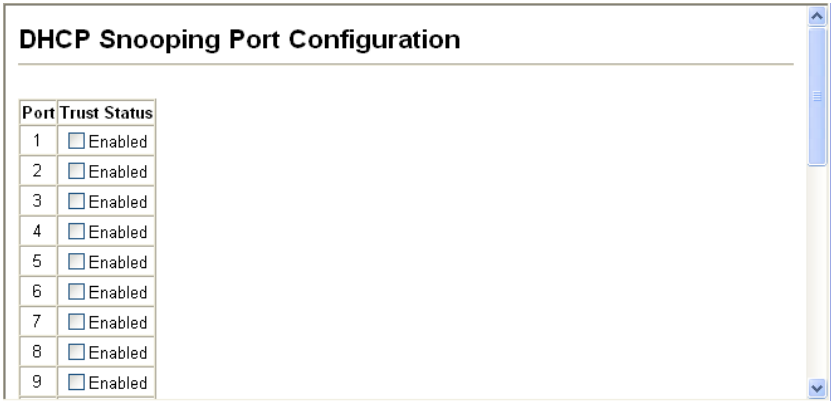

Figure 3-73 DHCP Snooping Port Configuration

**CLI** – This example shows how to enable the DHCP Snooping Trust Status for ports.

```

Console(config)#interface ethernet 1/5
Console(config-if)#ip dhcp snooping trust                               4-166
Console(config-if)#end
Console#show ip dhcp snooping                                           4-170
Global DHCP Snooping status: disable
DHCP Snooping Information Option Status: disable
DHCP Snooping Information Policy: replace
DHCP Snooping is configured on the following VLANs:

Verify Source Mac-Address: enable
Interface           Trusted
-----
Eth 1/1             No
Eth 1/2             No
Eth 1/3             No
Eth 1/4             No
Eth 1/5             Yes
:
:
:

```

## Displaying DHCP Snooping Binding Information

Binding table entries can be displayed on the Binding Information page.

### Command Attributes

- **Store DHCP snooping binding entries to flash.** – Writes all dynamically learned snooping entries to flash memory.

This function can be used to store the currently learned dynamic DHCP snooping entries to flash memory. These entries will be restored to the snooping table when the switch is reset. However, note that the lease time shown for a dynamic entry that has been restored from flash memory will no longer be valid.

- **Clear DHCP snooping binding entries from flash.** – Removes all dynamically learned snooping entries from flash memory.
- **No.** – Entry number for DHCP snooping binding information.
- **Unit** – Stack unit.
- **Port** – Port number.
- **VLAN ID** – VLAN for which DHCP snooping has been enabled.
- **MAC Address** – Physical address associated with the entry.
- **IP Address** – IP address corresponding to the client.
- **IP Address Type** – Indicates an IPv4 or IPv6 address type.
- **Lease Time (Seconds)** – The time for which this IP address has been leased to the client.

**Web** – Click DHCP Snooping, DHCP Snooping Binding Information.



Figure 3-74 DHCP Snooping Binding Information

**CLI** – This example shows how to display the DHCP Snooping binding table entries.

```
Console#show ip dhcp snooping binding 4-170
MacAddress      IpAddress      Lease(sec)  Type           VLAN  Interface
-----
11-22-33-44-55-66  192.168.0.99      0 Dynamic           1    Eth 1/5
Console#
```



## IP Source Guard

IP Source Guard is a security feature that filters IP traffic on network interfaces based on manually configured entries in the IP Source Guard table, or dynamic entries in the DHCP Snooping table when enabled (see “DHCP Snooping” on page 3-116). IP source guard can be used to prevent traffic attacks caused when a host tries to use the IP address of a neighbor to access the network. This section describes commands used to configure IP Source Guard.

### Configuring Ports for IP Source Guard

IP Source Guard is used to filter traffic on an unsecure port which receives messages from outside the network or firewall, and therefore may be subject to traffic attacks caused by a host trying to use the IP address of a neighbor.

### Command Usage

- Setting source guard mode to SIP (Source IP) or SIP-MAC (Source IP and MAC) enables this function on the selected port. Use the SIP option to check the VLAN ID, source IP address, and port number against all entries in the binding table. Use the SIP-MAC option to check these same parameters, plus the source MAC address. If no matching entry is found, the packet is dropped.
- When enabled, traffic is filtered based upon dynamic entries learned via DHCP snooping (see “Configuring DHCP Snooping” on page 3-117), or static addresses configured in the source guard binding table.
- If IP source guard is enabled, an inbound packet’s IP address (sip option) or both its IP address and corresponding MAC address (sip-mac option) will be checked against the binding table. If no matching entry is found, the packet will be dropped.
- Filtering rules are implemented as follows:
  - If the DHCP snooping is disabled (see page 3-117), IP source guard will check the VLAN ID, source IP address, port number, and source MAC address (for the sip-mac option). If a matching entry is found in the binding table and the entry type is static IP source guard binding, the packet will be forwarded.
  - If the DHCP snooping is enabled, IP source guard will check the VLAN ID, source IP address, port number, and source MAC address (for the sip-mac option). If a matching entry is found in the binding table and the entry type is static IP source guard binding, or dynamic DHCP snooping binding, the packet will be forwarded.
  - If IP source guard is enabled on an interface for which IP source bindings have not yet been configured (neither by static configuration in the IP source guard binding table nor dynamically learned from DHCP snooping), the switch will drop all IP traffic on that port, except for DHCP packets.

### Command Attributes

- **Filter Type** – Configures the switch to filter inbound traffic based source IP address, or source IP address and corresponding MAC address. (Default: None)
  - **None** – Disables IP source guard filtering on the port.

### 3 Configuring the Switch

- **SIP** – Enables traffic filtering based on IP addresses stored in the binding table.
- **SIP-MAC** – Enables traffic filtering based on IP addresses and corresponding MAC addresses stored in the binding table.

**Web** – Click IP Source Guard, Port Configuration. Set the required filtering type for each port and click Apply.

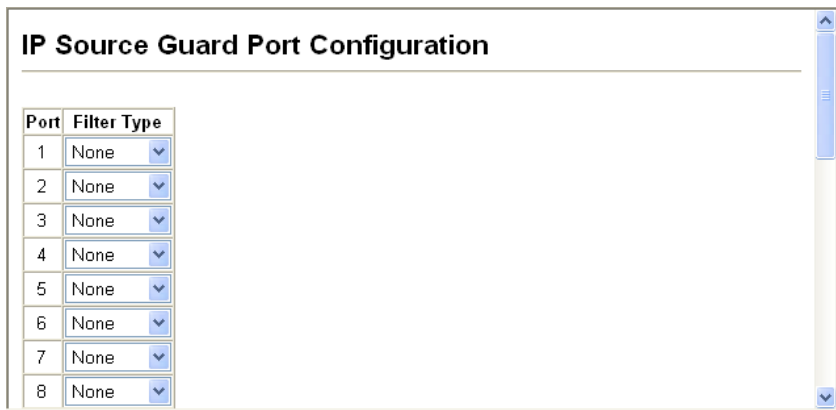

Figure 3-75 IP Source Guard Port Configuration

**CLI** – This example shows how to enable IP source guard on port 5 to check the source IP address for ingress packets against the binding table.

```
Console(config)#interface ethernet 1/5
Console(config-if)#ip source-guard sip                               4-171
Console(config-if)#end
Console#show ip source-guard                                       4-174
Interface    Filter-type
-----
Eth 1/1      DISABLED
Eth 1/2      DISABLED
Eth 1/3      DISABLED
Eth 1/4      DISABLED
Eth 1/5      SIP
Eth 1/6      DISABLED
:
```

### Configuring Static Binding for IP Source Guard

Adds a static addresses to the source-guard binding table. Table entries include a MAC address, IP address, lease time, entry type (Static, Dynamic), VLAN identifier, and port identifier. All static entries are configured with an infinite lease time, which is indicated with a value of zero in the table.

#### Command Usage

- Static addresses entered in the source guard binding table are automatically configured with an infinite lease time. Dynamic entries learned via DHCP snooping

are configured by the DHCP server itself, of which static entries include a manually configured lease time.

- Static bindings are processed as follows:
  - If there is no entry with the same VLAN ID and MAC address, a new entry is added to the binding table using the type “static IP source guard binding.”
  - If there is an entry with the same VLAN ID and MAC address, and the type of entry is static IP source guard binding, then the new entry will replace the old one.
  - If there is an entry with the same VLAN ID and MAC address, and the type of the entry is dynamic DHCP snooping binding, then the new entry will replace the old one and the entry type will be changed to static IP source guard binding.

### Command Attributes

- **Static Binding Table Counts** – The total number of static entries in the table.
- **Current Static Binding Table** – The list of current static entries in the table.
- **Port** – The port to which a static entry is bound. (Range: 1-28)
- **VLAN ID** – ID of a configured VLAN (Range: 1-4094)
- **MAC Address** – A valid unicast MAC address.
- **IP Address** – A valid unicast IP address, including classful types A, B or C.

**Web** – Click IP Source Guard, Static Configuration. Select the VLAN and port to which the entry will be bound, enter the MAC address and associated IP address, then click Add.

### Static IP Source Guard Binding Configuration

---

Static Binding Table Counts	<input type="text" value="1"/>
Current Static Binding Table	VLAN 1, 00-12-34-56-78-9A, Unit 1, Port 9, 192.168.1.35, IPv4, Lease Time 0 Seconds
Port	<input type="text" value="1"/>
VLAN ID	<input type="text" value="1"/>
MAC Address (XX-XX-XX-XX-XX-XX)	<input type="text"/>
IP Address	<input type="text"/>

Figure 3-76 Static IP Source Guard Binding Configuration

### 3 Configuring the Switch

**CLI** – This example configures a static source-guard binding on port 5.

```
Console(config)#ip source-guard binding 11-22-33-44-55-66 vlan 1
192.168.0.99 interface ethernet 1/5
Console(config)#
```

4-174

#### Displaying Information for Dynamic IP Source Guard Bindings

Use the Dynamic Information page to display the source-guard binding table for a selected interface.

#### Command Attributes

- **Query by** – Select an interface to display the source-guard binding. (Options: Port, VLAN, MAC Address, or IP Address)
- **Dynamic Binding Table Counts** – Displays the number of IP addresses in the source-guard binding table.
- **Current Dynamic Binding Table** – Displays the IP addresses in the source-guard binding table.

**Web** – Click IP Source Guard, Dynamic Information.

#### Dynamic IP Source Guard Binding Information

---

**Query by:**

<input type="checkbox"/> Port	1
<input type="checkbox"/> VLAN	1
<input type="checkbox"/> MAC Address	
<input type="checkbox"/> IP Address	

Dynamic IP Source Guard Binding Table	
Dynamic Binding Table Counts	0
Current Dynamic Binding Table	(none)

Figure 3-77 Dynamic IP Source Guard Binding Information

**CLI** – This example shows how to configure a static source-guard binding on port 5.

```
Console#show ip source-guard binding
MacAddress      IpAddress      Lease(sec)  Type           VLAN
Interface
-----
11-22-33-44-55-66 192.168.0.99      0 Static           1 Eth 1/5
Console#
```

4-174

# Port Configuration

## Displaying Connection Status

You can use the Port Information or Trunk Information pages to display the current connection status, including link state, speed/duplex mode, flow control, and auto-negotiation.

### Field Attributes (Web)

- **Name** – Interface label.
- **Type** – Indicates the port type. (100BASE-TX, 1000BASE-T, or SFP)
- **Admin Status** – Shows if the interface is enabled or disabled.
- **Oper Status** – Indicates if the link is Up or Down.
- **Speed Duplex Status** – Shows the current speed and duplex mode. (Auto, or fixed choice)
- **Flow Control Status** – Indicates the type of flow control currently in use. (IEEE 802.3x, Back-Pressure or None)
- **Autonegotiation** – Shows if auto-negotiation is enabled or disabled.
- **Media Type**<sup>6</sup> – Media type used for the combo ports. (Options: Copper-Forced, SFP-Forced, or SFP-Preferred-Auto; Default: SFP-Preferred-Auto)
- **Trunk Member**<sup>6</sup> – Shows if port is a trunk member.
- **Creation**<sup>7</sup> – Shows if a trunk is manually configured or dynamically set via LACP.

**Web** – Click Port, Port Information or Trunk Information.

Port Information									
Port	Name	Type	Admin Status	Oper Status	Speed Duplex Status	Flow Control Status	Autonegotiation	Media Type	Trunk Member
1		100Base-TX	Enabled	Down	10half	None	Enabled	None	
2		100Base-TX	Enabled	Down	10half	None	Enabled	None	
3		100Base-TX	Enabled	Down	10half	None	Enabled	None	
4		100Base-TX	Enabled	Down	10half	None	Enabled	None	
5		100Base-TX	Enabled	Up	100full	None	Enabled	None	
6		100Base-TX	Enabled	Down	10half	None	Enabled	None	
7		100Base-TX	Enabled	Down	10half	None	Enabled	None	
8		100Base-TX	Enabled	Down	10half	None	Enabled	None	

Figure 3-78 Displaying Port/Trunk Information

6. Port information only.

7. Trunk information only.

#### Field Attributes (CLI)

##### *Basic Information:*

- **Port type** – Indicates the port type. (100BASE-TX, 1000BASE-T, or SFP)
- **MAC address** – The physical layer address for this port. (To access this item on the web, see “Setting the Switch’s IP Address” on page 3-17.)

##### *Configuration:*

- **Name** – Interface label.
- **Port Admin** – Shows if the interface is enabled or disabled (i.e., up or down).
- **Speed-duplex** – Shows the current speed and duplex mode. (Auto, or fixed choice)
- **Capabilities** – Specifies the capabilities to be advertised for a port during auto-negotiation. (To access this item on the web, see “Configuring Interface Connections” on page 3-48.) The following capabilities are supported.
  - **10half** - Supports 10 Mbps half-duplex operation
  - **10full** - Supports 10 Mbps full-duplex operation
  - **100half** - Supports 100 Mbps half-duplex operation
  - **100full** - Supports 100 Mbps full-duplex operation
  - **1000full** - Supports 1000 Mbps full-duplex operation
  - **Sym** - Transmits and receives pause frames for flow control
  - **FC** - Supports flow control
- **Broadcast Storm** – Shows if broadcast storm control is enabled or disabled.
- **Broadcast Storm Limit** – Shows the broadcast storm threshold. (240-1488100 packets per second)
- **Multicast Storm** – Shows if multicast storm control is enabled or disabled.
- **Multicast Storm Limit** – Shows the multicast storm threshold. (64 - 1,000,000 kilobits per second)
- **Unknown Unicast Storm** – Shows if unknown unicast storm control is enabled or disabled.
- **Unknown Unicast Storm Limit** – Shows the unknown unicast storm threshold. (64 - 1,000,000 kilobits per second)
- **Flow Control** – Shows if flow control is enabled or disabled.
- **LACP** – Shows if LACP is enabled or disabled.
- **Port Security** – Shows if port security is enabled or disabled.
- **Max MAC Count** – Shows the maximum number of MAC address that can be learned by a port. (0 - 1024 addresses)
- **Port Security Action** – Shows the response to take when a security violation is detected. (Display options: shutdown, trap, trap-and-shutdown, or none)
- **Media Type** – Shows the forced or preferred port type to use for combination ports 25-28 on iES4028F and 27-28 on iES4028FP. (Display options: copper forced, SFP forced, SFP preferred auto)
- **Giga PHY Mode** – Shows the master/slave configuration mode used by negotiate a 1000BASE-T full duplex connection for a link pair.

**Current Status:**

- **Link Status** – Indicates if the link is up or down.
- **Port Operation Status** – Provides detailed information on port state. (Displayed only when the link is up.)
- **Operation Speed-duplex** – Shows the current speed and duplex mode.
- **Flow Control Type** – Indicates the type of flow control currently in use. (IEEE 802.3x, Back-Pressure or none)

**CLI** – This example shows the connection status for Port 5.

```

Console#show interfaces status ethernet 1/5
Information of Eth 1/5
Basic Information:
  Port Type:                100TX
  Mac Address:              00-16-B6-F0-71-41
Configuration:
  Name:
  Port Admin:              Up
  Speed-duplex:            Auto
  Capabilities:            10half, 10full, 100half, 100full
  Broadcast Storm:        Enabled
  Broadcast Storm Limit:   64 Kbits/second
  Multicast Storm:        Disabled
  Multicast Storm Limit:  64 Kbits/second
  UnknownUnicast Storm:   Disabled
  UnknownUnicast Storm Limit: 64 Kbits/second
  Flow Control:            Disabled
  LACP:                    Disabled
  Port Security:          Disabled
  Max MAC Count:          0
  Port Security Action:   None
  Media Type:              None
  Giga PHY mode:          Auto preferred master
Current Status:
  Link Status:             Down
  Operation Speed-duplex:  10half
  Flow Control Type:      None
Console#
  
```

## Configuring Interface Connections

You can use the Port Configuration or Trunk Configuration page to enable/disable an interface, set auto-negotiation and the interface capabilities to advertise, or manually fix the speed, duplex mode, and flow control.

### Command Usage

- Auto-negotiation must be disabled before you can configure or force the interface to use the Speed/Duplex Mode or Flow Control options.
- When using auto-negotiation, the optimal settings will be negotiated between the link partners based on their advertised capabilities. To set the speed, duplex mode, or flow control under auto-negotiation, the required operation modes must be specified in the capabilities list for an interface.
- The 1000BASE-T standard does not support forced mode. Auto-negotiation should always be used to establish a connection over any 1000BASE-T port or

trunk. If not used, the success of the link process cannot be guaranteed when connecting to other types of switches. However, this switch does provide a means of safely forcing a link to operate at 1000 Mbps, full-duplex using the Giga Phy Mode attribute described below.

#### Command Attributes

- **Name** – Allows you to label an interface. (Range: 1-64 characters)
- **Admin** – Allows you to manually disable an interface. You can disable an interface due to abnormal behavior (e.g., excessive collisions), and then reenable it after the problem has been resolved. You may also disable an interface for security reasons.
- **Speed/Duplex** – Allows you to manually set the port speed and duplex mode. (i.e., with auto-negotiation disabled)
- **Flow Control** – Allows automatic or manual selection of flow control (that is, with auto-negotiation disabled).

Flow control can eliminate frame loss by “blocking” traffic from end stations or segments connected directly to the switch when its buffers fill. When enabled, back pressure is used for half-duplex operation and IEEE 802.3-2005 (formally IEEE 802.3x) for full-duplex operation.

Avoid using flow control on a port connected to a hub unless it is actually required to solve a problem. Otherwise back pressure jamming signals may degrade overall performance for the segment attached to the hub.

- **Giga PHY Mode** – Forces two connected ports in to a master/slave configuration to enable 1000BASE-T full duplex for Gigabit ports 25-28. The following options are supported:
  - **Master** - Sets the selected port as master.
  - **Slave** - Sets the selected port as slave.
  - **Auto Prefer Master** - Uses master mode as the initial configuration setting regardless of the mode configured at the other end of the link.
  - **Auto Prefer Slave** - Uses slave mode as the initial configuration regardless of the mode configured at the other end of the link.

To force 1000full operation requires the ports at both ends of a link to establish their role in the connection process as a master or slave. Before using this feature, auto-negotiation must first be disabled, and the Speed/Duplex attribute set to 1000full. Then select compatible Giga PHY modes at both ends of the link. Note that using one of the preferred modes ensures that the ports at both ends of a link will eventually cooperate to establish a valid master-slave relationship.

- **Autonegotiation (Port Capabilities)** – Allows auto-negotiation to be enabled/disabled. When auto-negotiation is enabled, you need to specify the capabilities to be advertised. When auto-negotiation is disabled, you can force the settings for speed, mode, and flow control. The following capabilities are supported.
  - **10half** - Supports 10 Mbps half-duplex operation
  - **10full** - Supports 10 Mbps full-duplex operation
  - **100half** - Supports 100 Mbps half-duplex operation
  - **100full** - Supports 100 Mbps full-duplex operation



- **1000full** (Gigabit only) - Supports 1000 Mbps full-duplex operation (Default: Autonegotiation enabled; Advertised capabilities for 100BASE-TX – 10half, 10full, 100half, 100full; 100BASE-T – 10half, 10full, 100full, 1000full; 1000BASE-SX/LX/LH – 1000full)
- **Media Type** – Configures the forced/preferred port type to use for the combination ports. (Ports 25-28 on iES4028F and 27-28 on iES4028FP)
  - **Copper-Forced** - Always uses the built-in RJ-45 port.
  - **SFP-Forced** - Always uses the SFP port (even if module is not installed).
  - **SFP-Preferred-Auto** - Uses SFP port if both combination types are functioning and the SFP port has a valid link. (This is the default.)
- **Trunk** – Indicates if a port is a member of a trunk. To create trunks and select port members, see “Creating Trunk Groups” on page 3-132.

**Web** – Click Port, Port Configuration or Trunk Configuration. Modify the required interface settings, and click Apply.

Port Configuration											
Port	Name	Admin	Speed Duplex	Flow Control	Giga PHY Mode	Autonegotiation				Media Type	Trunk
1		<input checked="" type="checkbox"/> Enabled	100full	<input checked="" type="checkbox"/> Enabled	Auto Prefer Master	<input checked="" type="checkbox"/> Enabled	<input checked="" type="checkbox"/> 10h <input checked="" type="checkbox"/> 100h <input type="checkbox"/> 1000h <input type="checkbox"/> Sym	<input checked="" type="checkbox"/> 10f <input checked="" type="checkbox"/> 100f <input type="checkbox"/> 1000f <input type="checkbox"/> FC		None	
2		<input checked="" type="checkbox"/> Enabled	100full	<input checked="" type="checkbox"/> Enabled	Auto Prefer Master	<input checked="" type="checkbox"/> Enabled	<input checked="" type="checkbox"/> 10h <input checked="" type="checkbox"/> 100h <input type="checkbox"/> 1000h <input type="checkbox"/> Sym	<input checked="" type="checkbox"/> 10f <input checked="" type="checkbox"/> 100f <input type="checkbox"/> 1000f <input type="checkbox"/> FC		None	
3		<input checked="" type="checkbox"/> Enabled	100half	<input type="checkbox"/> Enabled	Auto Prefer Master	<input type="checkbox"/> Enabled	<input type="checkbox"/> 10h <input type="checkbox"/> 100h <input type="checkbox"/> 1000h <input type="checkbox"/> Sym	<input type="checkbox"/> 10f <input type="checkbox"/> 100f <input type="checkbox"/> 1000f <input type="checkbox"/> FC		None	
4		<input checked="" type="checkbox"/> Enabled	100full	<input checked="" type="checkbox"/> Enabled	Auto Prefer Master	<input checked="" type="checkbox"/> Enabled	<input checked="" type="checkbox"/> 10h <input checked="" type="checkbox"/> 100h <input type="checkbox"/> 1000h <input type="checkbox"/> Sym	<input checked="" type="checkbox"/> 10f <input checked="" type="checkbox"/> 100f <input type="checkbox"/> 1000f <input type="checkbox"/> FC		None	
5		<input checked="" type="checkbox"/> Enabled	100full	<input checked="" type="checkbox"/> Enabled	Auto Prefer Master	<input checked="" type="checkbox"/> Enabled	<input checked="" type="checkbox"/> 10h <input checked="" type="checkbox"/> 100h <input type="checkbox"/> 1000h <input type="checkbox"/> Sym	<input checked="" type="checkbox"/> 10f <input checked="" type="checkbox"/> 100f <input type="checkbox"/> 1000f <input type="checkbox"/> FC		None	
6		<input checked="" type="checkbox"/> Enabled	100full	<input checked="" type="checkbox"/> Enabled	Auto Prefer Master	<input checked="" type="checkbox"/> Enabled	<input checked="" type="checkbox"/> 10h <input checked="" type="checkbox"/> 100h <input type="checkbox"/> 1000h <input type="checkbox"/> Sym	<input checked="" type="checkbox"/> 10f <input checked="" type="checkbox"/> 100f <input type="checkbox"/> 1000f <input type="checkbox"/> FC		None	
7		<input checked="" type="checkbox"/> Enabled	100full	<input checked="" type="checkbox"/> Enabled	Auto Prefer Master	<input checked="" type="checkbox"/> Enabled	<input checked="" type="checkbox"/> 10h <input checked="" type="checkbox"/> 100h <input type="checkbox"/> 1000h <input type="checkbox"/> Sym	<input checked="" type="checkbox"/> 10f <input checked="" type="checkbox"/> 100f <input type="checkbox"/> 1000f <input type="checkbox"/> FC		None	
8		<input checked="" type="checkbox"/> Enabled	100full	<input checked="" type="checkbox"/> Enabled	Auto Prefer Master	<input checked="" type="checkbox"/> Enabled	<input checked="" type="checkbox"/> 10h <input checked="" type="checkbox"/> 100h <input type="checkbox"/> 1000h <input type="checkbox"/> Sym	<input checked="" type="checkbox"/> 10f <input checked="" type="checkbox"/> 100f <input type="checkbox"/> 1000f <input type="checkbox"/> FC		None	

Figure 3-79 Port/Trunk Configuration

**CLI** – Select the interface, and then enter the required settings.

```

Console(config)#interface ethernet 1/13                               4-187
Console(config-if)#description RD SW#13                             4-188
Console(config-if)#shutdown                                         4-194
.
Console(config-if)#no shutdown
Console(config-if)#no negotiation                                   4-189
Console(config-if)#speed-duplex 100half                             4-188
Console(config-if)#flowcontrol                                     4-191
.
Console(config-if)#negotiation
Console(config-if)#capabilities 100half                             4-190
Console(config-if)#capabilities 100full
Console(config-if)#capabilities flowcontrol

```

### Creating Trunk Groups

You can create multiple links between devices that work as one virtual, aggregate link. A port trunk offers a dramatic increase in bandwidth for network segments where bottlenecks exist, as well as providing a fault-tolerant link between two devices. You can create up to eight trunks at a time.

The switch supports both static trunking and dynamic Link Aggregation Control Protocol (LACP). Static trunks have to be manually configured at both ends of the link, and the switches must comply with the Cisco EtherChannel standard. On the other hand, LACP configured ports can automatically negotiate a trunked link with LACP-configured ports on another device. You can configure any number of ports on the switch as LACP, as long as they are not already configured as part of a static trunk. If ports on another device are also configured as LACP, the switch and the other device will negotiate a trunk link between them. If an LACP trunk consists of more than eight ports, all other ports will be placed in a standby mode. Should one link in the trunk fail, one of the standby ports will automatically be activated to replace it.

#### Command Usage

Besides balancing the load across each port in the trunk, the other ports provide redundancy by taking over the load if a port in the trunk fails. However, before making any physical connections between devices, use the web interface or CLI to specify the trunk on the devices at both ends. When using a port trunk, take note of the following points:

- Finish configuring port trunks before you connect the corresponding network cables between switches to avoid creating a loop.
- You can create up to eight trunks on a switch, with up to eight ports per trunk.
- The ports at both ends of a connection must be configured as trunk ports.
- When configuring static trunks on switches of different types, they must be compatible with the Cisco EtherChannel standard.
- The ports at both ends of a trunk must be configured in an identical manner, including communication mode (i.e., speed, duplex mode and flow control), VLAN assignments, and CoS settings.
- Any of the Gigabit ports on the front panel can be trunked together, including ports of different media types.
- All the ports in a trunk have to be treated as a whole when moved from/to, added or deleted from a VLAN.
- STP, VLAN, and IGMP settings can only be made for the entire trunk.

## Statically Configuring a Trunk

### Command Usage

- When configuring static trunks, you may not be able to link switches of different types, depending on the manufacturer's implementation. However, note that the static trunks on this switch are Cisco EtherChannel compatible.
- To avoid creating a loop in the network, be sure you add a static trunk via the configuration interface before connecting the ports, and also disconnect the ports before removing a static trunk via the configuration interface.

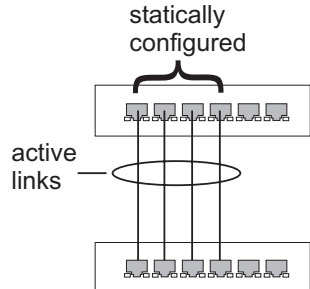

### Command Attributes

- **Member List** (Current) – Shows configured trunks (Trunk ID, Unit, Port).
- **New** – Includes entry fields for creating new trunks.
  - **Trunk** – Trunk identifier. (Range: 1-8)
  - **Port** – Port identifier. (Range: 1-28)

**Web** – Click Port, Trunk Membership. Enter a trunk ID of 1-8 in the Trunk field, select any of the switch ports from the scroll-down port list, and click Add. After you have completed adding ports to the member list, click Apply.

### Trunk Membership

---

**Member List:**

Current: New:

Trunk1, Unit1 Port5  
 Trunk1, Unit1 Port6  
 Trunk1, Unit1 Port7  
 Trunk1, Unit1 Port8

Trunk (1-8)   
 Port

Figure 3-80 Configuring Static Trunks

### 3 Configuring the Switch

**CLI** – This example creates trunk 2 with ports 1 and 2. Just connect these ports to two static trunk ports on another switch to form a trunk.

```
Console(config)#interface port-channel 2                               4-187
Console(config-if)#exit
Console(config)#interface ethernet 1/1                               4-187
Console(config-if)#channel-group 2                                   4-202
Console(config-if)#exit
Console(config)#interface ethernet 1/2
Console(config-if)#channel-group 2
Console(config-if)#end
Console#show interfaces status port-channel 2                         4-196
Information of Trunk 2
Basic information:
  Port type:                100TX
  Mac address:              00-12-CF-12-34-84
Configuration:
  Name:
  Port admin:              Up
  Speed-duplex:            Auto
  Capabilities:            10half, 10full, 100half, 100full
  Flow control:            Disabled
  Port security:           Disabled
  Max MAC count:          0
  Giga PHY mode: Auto preferred master
Current status:
  Created by:              User
  Link status:             Up
  Port operation status:   Up
  Operation speed-duplex:  100full
  Flow control type:       None
  Member Ports:           Eth1/1, Eth1/2,
Console#
```

## Enabling LACP on Selected Ports

### Command Usage

- To avoid creating a loop in the network, be sure you enable LACP before connecting the ports, and also disconnect the ports before disabling LACP.
- If the target switch has also enabled LACP on the connected ports, the trunk will be activated automatically.
- A trunk formed with another switch using LACP will automatically be assigned the next available trunk ID.
- If more than eight ports attached to the same target switch have LACP enabled, the additional ports will be placed in standby mode, and will only be enabled if one of the active links fails.
- All ports on both ends of an LACP trunk must be configured for full duplex, and auto-negotiation.
- Trunks dynamically established through LACP will also be shown in the Member List on the Trunk Membership menu (see page 3-133).

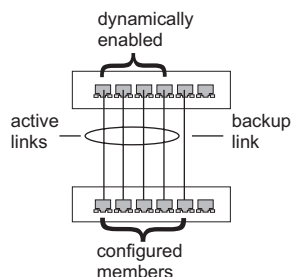

### Command Attributes

- **Member List (Current)** – Shows configured trunks (Port).
- **New** – Includes entry fields for creating new trunks.
  - **Port** – Port identifier. (Range: 1-28)

**Web** – Click Port, LACP, Configuration. Select any of the switch ports from the scroll-down port list and click Add. After you have completed adding ports to the member list, click Apply.

## LACP Configuration

---

**Member List:**

Current:

- Unit1 Port1
- Unit1 Port2
- Unit1 Port3
- Unit1 Port4
- Unit1 Port5
- Unit1 Port6

New:

<<Add

Remove

Port 1

Figure 3-81 LACP Trunk Configuration

### 3 Configuring the Switch

**CLI** – The following example enables LACP for ports 1 to 6. Just connect these ports to LACP-enabled trunk ports on another switch to form a trunk.

```
Console(config)#interface ethernet 1/1                                4-187
Console(config-if)#lACP                                           4-203
Console(config-if)#exit
:
Console(config)#interface ethernet 1/6
Console(config-if)#lACP
Console(config-if)#end
Console#show interfaces status port-channel 1                      4-196
Information of Trunk 1
Basic information:
  Port type:                100TX
  Mac address:              00-12-CF-12-34-89
Configuration:
Name:
  Port admin:              Up
  Speed-duplex:           Auto
  Capabilities:           10half, 10full, 100half, 100full
  Flow control status:    Disabled
  Port security:          Disabled
  Max MAC count:          0
  Giga PHY mode:          Auto preferred master
Current status:
  Created by:              LACP
  Link status:             Up
  Port operation status:   Up
  Operation speed-duplex: 100full
  Flow control type:       None
  Member Ports:           Eth1/1, Eth1/2, Eth1/3, Eth1/4, Eth1/5, Eth1/6,
Console#
```

## Configuring Parameters for LACP Group Members

### Dynamically Creating a Port Channel –

Ports assigned to a common port channel must meet the following criteria:

- Ports must have the same LACP System Priority.
- Ports must have the same LACP port Admin Key.
- However, if the “port channel” Admin Key is set (page 4-142), then the port Admin Key must be set to the same value for a port to be allowed to join a channel group.

**Note** – If the port channel admin key (lACP admin key, page 4-206) is not set (through the CLI) when a channel group is formed (i.e., it has a null value of 0), this key is set to the same value as the port admin key used by the interfaces that joined the group (lACP admin key, as described in this section and on page 4-205).

### Command Attributes

*Set Port Actor* – This menu sets the local side of an aggregate link; i.e., the ports on this switch.

- **Port** – Port number. (Range: 1-28)
- **System Priority** – LACP system priority is used to determine link aggregation group (LAG) membership, and to identify this device to other switches during LAG negotiations. (Range: 0-65535; Default: 32768)
  - Ports must be configured with the same system priority to join the same LAG.
  - System priority is combined with the switch's MAC address to form the LAG identifier. This identifier is used to indicate a specific LAG during LACP negotiations with other systems.
- **Admin Key** – The LACP administration key must be set to the same value for ports that belong to the same LAG. (Range: 0-65535; Default: 1)
- **Port Priority** – If a link goes down, LACP port priority is used to select a backup link. (Range: 0-65535; Default: 32768)

*Set Port Partner* – This menu sets the remote side of an aggregate link; i.e., the ports on the attached device. The command attributes have the same meaning as those used for the port actor. However, configuring LACP settings for the partner only applies to its administrative state, not its operational state, and will only take effect the next time an aggregate link is established with the partner.

### 3 Configuring the Switch

**Web** – Click Port, LACP, Aggregation Port. Set the System Priority, Admin Key, and Port Priority for the Port Actor. You can optionally configure these settings for the Port Partner. (Be aware that these settings only affect the administrative state of the partner, and will not take effect until the next time an aggregate link is formed with this device.) After you have completed setting the port LACP parameters, click Apply.

## Aggregation Port

**Set Port Actor:**

Port	System Priority (0-65535)	Admin Key (0-65535)	Port Priority (0-65535)
1	3	120	32768
2	3	120	32768
3	3	120	32768
4	3	120	32768
5	3	120	32768
6	3	120	32768
7	3	120	32768
8	3	120	32768
9	3	120	512

Figure 3-82 LACP Port Configuration



**CLI** – The following example configures LACP parameters for ports 1-4. Ports 1-4 are used as active members of the LAG.

```

Console(config)#interface ethernet 1/1                                4-187
Console(config-if)#lACP actor system-priority 3                    4-204
Console(config-if)#lACP actor admin-key 120                        4-205
Console(config-if)#lACP actor port-priority 128                   4-207
Console(config-if)#exit
:
:
Console(config)#interface ethernet 1/4
Console(config-if)#lACP actor system-priority 3
Console(config-if)#lACP actor admin-key 120
Console(config-if)#lACP actor port-priority 512
Console(config-if)#end
Console#show lACP sysid                                           4-208
Port Channel      System Priority      System MAC Address
-----
          1              3      00-12-CF-31-31-31
          2             32768     00-12-CF-31-31-31
          3             32768     00-12-CF-31-31-31
          4             32768     00-12-CF-31-31-31

Console#show lACP 1 internal                                     4-208
Port channel : 1
-----
Oper Key : 120
Admin Key : 0
Eth 1/1
-----
LACPDUs Internal:      30 sec
LACP System Priority:  3
LACP Port Priority:    128
Admin Key:             120
Oper Key:              120
Admin State : defaulted, aggregation, long timeout, LACP-activity
Oper State:            distributing, collecting, synchronization,
                       aggregation, long timeout, LACP-activity
:
:

```

## Configuring Parameters for LACP Groups

Use the Aggregator page to configure system parameters which apply to specific LACP groups.

### Command Attributes

- **Admin Key** – LACP administration key is used to identify a specific link aggregation group (LAG) during local LACP setup on the switch. (Range: 0-65535) Ports are only allowed to join the same LAG if (1) the LACP port system priority matches, (2) the LACP port admin key matches, and (3) the LACP port channel admin key matches (if configured).

If the port channel admin key is not set when a channel group is formed (that is, it has the null value of 0), this key is set to the same value as the port admin key used by the interfaces that joined the group. Note that when the LAG is no longer used, the port channel admin key is reset to 0.

### 3 Configuring the Switch

**Web** – Click Port, LACP, Aggregator. Set the Admin Key for the required LACP group, and click Apply.

#### Aggregator

Trunk	Admin Key (0-65535)
1	<input checked="" type="checkbox"/> Enabled <input type="text" value="3"/>
2	<input type="checkbox"/> Enabled <input type="text" value="0"/>
3	<input type="checkbox"/> Enabled <input type="text" value="0"/>
4	<input type="checkbox"/> Enabled <input type="text" value="0"/>
5	<input type="checkbox"/> Enabled <input type="text" value="0"/>
6	<input type="checkbox"/> Enabled <input type="text" value="0"/>
7	<input type="checkbox"/> Enabled <input type="text" value="0"/>
8	<input type="checkbox"/> Enabled <input type="text" value="0"/>

Figure 3-83 LACP Aggregation Group Configuration

**CLI** – The following example sets the LACP admin key for port channel 1.

```
Console(config)#interface port-channel 1 4-187  
Console(config-if)#lACP actor admin-key 3 4-206  
Console(config-if)#
```

### Displaying LACP Port Counters

You can display statistics for LACP protocol messages.

Table 3-8 LACP Port Counters

Field	Description
LACPDUs Sent	Number of valid LACPDUs transmitted from this channel group.
LACPDUs Received	Number of valid LACPDUs received on this channel group.
Marker Sent	Number of valid Marker PDUs transmitted from this channel group.
Marker Received	Number of valid Marker PDUs received by this channel group.
Marker Unknown Pkts	Number of frames received that either (1) Carry the Slow Protocols Ethernet Type value, but contain an unknown PDU, or (2) are addressed to the Slow Protocols group MAC Address, but do not carry the Slow Protocols Ethernet Type.
Marker Illegal Pkts	Number of frames that carry the Slow Protocols Ethernet Type value, but contain a badly formed PDU or an illegal value of Protocol Subtype.

**Web** – Click Port, LACP, Port Counters Information. Select a member port to display the corresponding information.

### LACP Port Counters Information

---

Member Port 1

**Trunk ID : 2**

LACPDUs Sent	307	LACPDUs Receive	296
Marker Sent	0	Marker Receive	0
Marker Unknown Pkts	0	Marker Illegal Pkts	0

**Figure 3-84 LACP - Port Counters Information**

**CLI** – The following example displays LACP counters.

```

Console#show lacp counters 4-208
Port channel : 1
-----
Eth 1/ 1
-----
  LACPDUs Sent:           91
  LACPDUs Receive:       43
  Marker Sent:            0
  Marker Receive:        0
  LACPDUs Unknown Pkts:  0
  LACPDUs Illegal Pkts:  0
:

```

### Displaying LACP Settings and Status for the Local Side

You can display configuration settings and the operational state for the local side of an link aggregation.

**Table 3-9 LACP Internal Configuration Information**

Field	Description
Oper Key	Current operational value of the key for the aggregation port.
Admin Key	Current administrative value of the key for the aggregation port.
LACPDUs Interval	Number of seconds before invalidating received LACPDU information.
LACP System Priority	LACP system priority assigned to this port channel.
LACP Port Priority	LACP port priority assigned to this interface within the channel group.

**Table 3-9 LACP Internal Configuration Information (Continued)**

Field	Description
Admin State, Oper State	<p>Administrative or operational values of the actor's state parameters:</p> <ul style="list-style-type: none"> <li>Expired – The actor's receive machine is in the expired state;</li> <li>Defaulted – The actor's receive machine is using defaulted operational partner information, administratively configured for the partner.</li> <li>Distributing – If false, distribution of outgoing frames on this link is disabled; i.e., distribution is currently disabled and is not expected to be enabled in the absence of administrative changes or changes in received protocol information.</li> <li>Collecting – Collection of incoming frames on this link is enabled; i.e., collection is currently enabled and is not expected to be disabled in the absence of administrative changes or changes in received protocol information.</li> <li>Synchronization – The System considers this link to be IN_SYNC; i.e., it has been allocated to the correct Link Aggregation Group, the group has been associated with a compatible Aggregator, and the identity of the Link Aggregation Group is consistent with the System ID and operational Key information transmitted.</li> <li>Aggregation – The system considers this link to be aggregatable; i.e., a potential candidate for aggregation.</li> <li>Long timeout – Periodic transmission of LACPDUs uses a slow transmission rate.</li> <li>LACP-Activity – Activity control value with regard to this link. (0: Passive; 1: Active)</li> </ul>

**Web** – Click Port, LACP, Port Internal Information. Select a port channel to display the corresponding information.

### LACP Port Internal Information

---

Interface Port 3

**Trunk ID : 1**

LACP System Priority	32768	LACP Port Priority	32768
Admin Key	3	Oper Key	3
LACPDUS Interval (secs)	30 seconds		
Admin State : Expired		Oper State : Expired	
Admin State : Defaulted	✔	Oper State : Defaulted	
Admin State : Distributing		Oper State : Distributing	✔
Admin State : Collecting		Oper State : Collecting	✔
Admin State : Synchronization		Oper State : Synchronization	✔
Admin State : Aggregation	✔	Oper State : Aggregation	✔
Admin State : Timeout	Long	Oper State : Timeout	Long
Admin State : LACP-Activity	✔	Oper State : LACP-Activity	✔

**Figure 3-85 LACP - Port Internal Information**

**CLI** – The following example displays the LACP configuration settings and operational state for the local side of port channel 1.

```

Console#show lacp 1 internal
Port channel : 1
-----
Oper Key : 120
Admin Key : 0
Eth 1/1
-----
LACPDUs Internal:      30 sec
LACP System Priority:  3
LACP Port Priority:    128
Admin Key:             120
Oper Key:              120
Admin State : defaulted, aggregation, long timeout, LACP-activity
Oper State:            distributing, collecting, synchronization,
                       aggregation, long timeout, LACP-activity
:
:
:

```

### Displaying LACP Settings and Status for the Remote Side

You can display configuration settings and the operational state for the remote side of an link aggregation.

**Table 3-10 LACP Neighbor Configuration Information**

Field	Description
Partner Admin System ID	LAG partner's system ID assigned by the user.
Partner Oper System ID	LAG partner's system ID assigned by the LACP protocol.
Partner Admin Port Number	Current administrative value of the port number for the protocol Partner.
Partner Oper Port Number	Operational port number assigned to this aggregation port by the port's protocol partner.
Port Admin Priority	Current administrative value of the port priority for the protocol partner.
Port Oper Priority	Priority value assigned to this aggregation port by the partner.
Admin Key	Current administrative value of the Key for the protocol partner.
Oper Key	Current operational value of the Key for the protocol partner.
Admin State	Administrative values of the partner's state parameters. (See preceding table.)
Oper State	Operational values of the partner's state parameters. (See preceding table.)

### 3 Configuring the Switch

**Web** – Click Port, LACP, Port Neighbors Information. Select a port channel to display the corresponding information.

**LACP Port Neighbors Information**

Interface Port **2**

Trunk ID : 1

Partner Admin System ID	32768, 00-00-00-00-00-00	Partner Oper System ID	32768, 00-12-CF-DF-9E-C0
Partner Admin Port Number	58	Partner Oper Port Number	2
Port Admin Priority	32768	Port Oper Priority	32768
Admin Key	0	Oper Key	4
Admin State : Expired		Oper State : Expired	
Admin State : Defaulted	✓	Oper State : Defaulted	
Admin State : Distributing	✓	Oper State : Distributing	✓
Admin State : Collecting	✓	Oper State : Collecting	✓
Admin State : Synchronization	✓	Oper State : Synchronization	✓
Admin State : Aggregation		Oper State : Aggregation	✓
Admin State : Timeout	Long	Oper State : Timeout	Long
Admin State : LACP-Activity		Oper State : LACP-Activity	✓

Figure 3-86 LACP - Port Neighbors Information

**CLI** – The following example displays the LACP configuration settings and operational state for the remote side of port channel 1.

```
Console#show lacp 1 neighbors 4-208
Port channel 1 neighbors
-----
Eth 1/1
-----
Partner Admin System ID: 32768, 00-00-00-00-00-00
Partner Oper System ID: 3, 00-12-CF-CE-2A-20
Partner Admin Port Number: 5
Partner Oper Port Number: 3
Port Admin Priority: 32768
Port Oper Priority: 128
Admin Key: 0
Oper Key: 120
Admin State: defaulted, distributing, collecting,
              synchronization, long timeout,
Oper State:  distributing, collecting, synchronization,
              aggregation, long timeout, LACP-activity
:
:
```

## Setting Broadcast Storm Thresholds

Broadcast storms may occur when a device on your network is malfunctioning, or if application programs are not well designed or properly configured. If there is too much broadcast traffic on your network, performance can be severely degraded or everything can come to complete halt.

You can protect your network from broadcast storms by setting a threshold for broadcast traffic for each port. Any broadcast packets exceeding the specified threshold will then be dropped.

### Command Usage

- Broadcast Storm Control is enabled by default.
- Broadcast control does not effect IP multicast traffic.

**Note:** Multicast and unknown unicast storm thresholds can also be set using the CLI (see the "switchport packet-rate" command on page 4-194).

### Command Attributes

- **Port**<sup>8</sup> - Port number.
- **Type** – Indicates the port type. (100BASE-TX, 1000BASE-T, or 1000BASE-SFP)
- **Protect Status** – Enables or disables broadcast storm control. (Default: Enabled)
- **Threshold** – Threshold as percentage of port bandwidth. (Range: 64-100000 kilobits per second for Fast Ethernet ports; 64-1000000 kilobits per second for Gigabit ports; Default: 64 kilobits per second)
- **Trunk**<sup>9</sup> – Shows if a port is a trunk member.

---

8. Port Broadcast Control

9. Trunk Broadcast Control

### 3 Configuring the Switch

**Web** – Click Port, Port/Trunk Broadcast Control. Set the threshold and mark the Enabled field for the required interface, then click Apply.

#### Port Broadcast Control

For a 100 Mbps port, the threshold range is 64 to 100000 kilobits per second.  
For a 1 Gbps port, the threshold range is 64 to 1000000 kilobits per second.

Port	Type	Protect Status	Threshold (64-1000000)	Trunk
1	100Base-TX	<input checked="" type="checkbox"/> Enabled	64 (kbits/sec)	
2	100Base-TX	<input checked="" type="checkbox"/> Enabled	64 (kbits/sec)	
3	100Base-TX	<input checked="" type="checkbox"/> Enabled	64 (kbits/sec)	
4	100Base-TX	<input checked="" type="checkbox"/> Enabled	64 (kbits/sec)	
5	100Base-TX	<input checked="" type="checkbox"/> Enabled	64 (kbits/sec)	
6	100Base-TX	<input checked="" type="checkbox"/> Enabled	64 (kbits/sec)	
7	100Base-TX	<input checked="" type="checkbox"/> Enabled	64 (kbits/sec)	

Figure 3-87 Port Broadcast Control

**CLI** – Specify any interface, and then enter the threshold. The following disables broadcast storm control for port 1, and then sets broadcast suppression at 500 kilobits per second for port 2.

```
Console(config)#interface ethernet 1/1                               4-187
Console(config-if)#no switchport broadcast                          4-194
Console(config-if)#exit
Console(config)#interface ethernet 1/2
Console(config-if)#switchport broadcast packet-rate 500           4-194
Console(config-if)#end
Console#show interfaces switchport ethernet 1/2                    4-199
Information of Eth 1/2
Broadcast Threshold:           Enabled, 500 Kbits/second
Multicast Threshold:           Disabled
Unknown-unicast Threshold:     Disabled
LACP Status:                   Disabled
Ingress Rate Limit:            Disabled, 100000 Kbits per second
Egress Rate Limit:             Disabled, 100000 Kbits per second
VLAN Membership Mode:          Hybrid
Ingress Rule:                   Enabled
Acceptable Frame Type:         All frames
Native VLAN:                    1
Priority for Untagged Traffic:   0
GVRP Status:                   Disabled
Allowed VLAN:                   1 (u), 4093 (t),
Forbidden VLAN:
Private-VLAN Mode:              NONE
Private-VLAN host-association: NONE
Private-VLAN Mapping:           NONE
802.1Q-tunnel Status:           Disable
802.1Q-tunnel Mode:             NORMAL
802.1Q-tunnel TPID:            8100 (Hex)
Console#
```



## Configuring Port Mirroring

You can mirror traffic from any source port to a target port for real-time analysis. You can then attach a logic analyzer or RMON probe to the target port and study the traffic crossing the source port in a completely unobtrusive manner.

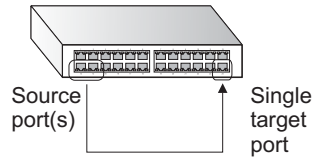

### Command Usage

- Monitor port speed should match or exceed source port speed, otherwise traffic may be dropped from the monitor port.
- All mirror sessions must share the same destination port.
- When mirroring port traffic, the target port must be included in the same VLAN as the source port when using MSTP (see “Spanning Tree Algorithm Configuration” on page 3-161).

### Command Attributes

- **Mirror Sessions** – Displays a list of current mirror sessions.
- **Source Port** – The port whose traffic will be monitored. (Range: 1-28)
- **Type** – Allows you to select which traffic to mirror to the target port, Rx (receive), Tx (transmit), or Both. (Default: Rx)
- **Target Port** – The port that will mirror the traffic on the source port. (Range: 1-28)

**Web** – Click Port, Mirror Port Configuration. Specify the source port, the traffic type to be mirrored, and the monitor port, then click Add.

### Mirror Port Configuration

---

Mirror Sessions:

Source: 1/10 Both Destination: 1/13

New:

Source Port	1
Type	Rx
Target Port	1

<<Add
Remove

Figure 3-88 Mirror Port Configuration

**CLI** – Use the interface command to select the monitor port, then use the port monitor command to specify the source port and traffic type.

```

Console(config)#interface ethernet 1/10 4-187
Console(config-if)#port monitor ethernet 1/13 tx 4-218
Console(config-if)#
  
```

## Configuring Rate Limits

This function allows the network manager to control the maximum rate for traffic received on a port or transmitted from a port. Rate limiting is configured on ports at the edge of a network to limit traffic into or out of the switch. Packets that exceed the acceptable amount of traffic are dropped.

Rate limiting can be applied to individual ports or trunks. When an interface is configured with this feature, the traffic rate will be monitored by the hardware to verify conformity. Non-conforming traffic is dropped, conforming traffic is forwarded without any changes.

### Rate Limit Configuration

Use the rate limit configuration pages to apply rate limiting.

### Command Usage

Input and output rate limits can be enabled or disabled for individual interfaces.

### Command Attributes

- **Port/Trunk** – Displays the port/trunk number.
- **Rate Limit Status** – Enables or disables the rate limit. (Default: Disabled)
- **Rate Limit** – Sets the rate limit level. (Range: 64 - 100000 kilobits per second for Fast Ethernet ports; 64 to 1000000 kilobits per second for Gigabit Ethernet ports)

**Web** – Click Port, Rate Limit, Input/Output Port/Trunk Configuration. Set the Input Rate Limit Status or Output Rate Limit Status, then set the rate limit for the individual interfaces, and click Apply.

Port	Input Rate Limit Status	Input Rate Limit (Kbps)	Trunk
1	<input checked="" type="checkbox"/> Enabled	100000	
2	<input checked="" type="checkbox"/> Enabled	100000	
3	<input checked="" type="checkbox"/> Enabled	100000	
4	<input checked="" type="checkbox"/> Enabled	100000	
5	<input checked="" type="checkbox"/> Enabled	100000	
6	<input checked="" type="checkbox"/> Enabled	100000	

Figure 3-89 Input Rate Limit Port Configuration

**CLI** - This example sets the rate limit level for input traffic passing through port 3.

```
Console(config)#interface ethernet 1/3 4-187
Console(config-if)#rate-limit input 500 4-220
Console(config-if)#
```

## Showing Port Statistics

You can display standard statistics on network traffic from the Interfaces Group and Ethernet-like MIBs, as well as a detailed breakdown of traffic based on the RMON MIB. Interfaces and Ethernet-like statistics display errors on the traffic passing through each port. This information can be used to identify potential problems with the switch (such as a faulty port or unusually heavy loading). RMON statistics provide access to a broad range of statistics, including a total count of different frame types and sizes passing through each port. All values displayed have been accumulated since the last system reboot, and are shown as counts per second. Statistics are refreshed every 60 seconds by default.

**Note:** RMON groups 2, 3 and 9 can only be accessed using SNMP management software such as HP OpenView.

**Table 3-11 Port Statistics**

Parameter	Description
<i>Interface Statistics</i>	
Received Octets	The total number of octets received on the interface, including framing characters.
Received Unicast Packets	The number of subnetwork-unicast packets delivered to a higher-layer protocol.
Received Multicast Packets	The number of packets, delivered by this sub-layer to a higher (sub-)layer, which were addressed to a multicast address at this sub-layer.
Received Broadcast Packets	The number of packets, delivered by this sub-layer to a higher (sub-)layer, which were addressed to a broadcast address at this sub-layer.
Received Discarded Packets	The number of inbound packets which were chosen to be discarded even though no errors had been detected to prevent their being deliverable to a higher-layer protocol. One possible reason for discarding such a packet could be to free up buffer space.
Received Unknown Packets	The number of packets received via the interface which were discarded because of an unknown or unsupported protocol.
Received Errors	The number of inbound packets that contained errors preventing them from being deliverable to a higher-layer protocol.
Transmit Octets	The total number of octets transmitted out of the interface, including framing characters.
Transmit Unicast Packets	The total number of packets that higher-level protocols requested be transmitted to a subnetwork-unicast address, including those that were discarded or not sent.
Transmit Multicast Packets	The total number of packets that higher-level protocols requested be transmitted, and which were addressed to a multicast address at this sub-layer, including those that were discarded or not sent.
Transmit Broadcast Packets	The total number of packets that higher-level protocols requested be transmitted, and which were addressed to a broadcast address at this sub-layer, including those that were discarded or not sent.

**Table 3-11 Port Statistics (Continued)**

Parameter	Description
Transmit Discarded Packets	The number of outbound packets which were chosen to be discarded even though no errors had been detected to prevent their being transmitted. One possible reason for discarding such a packet could be to free up buffer space.
Transmit Errors	The number of outbound packets that could not be transmitted because of errors.
<i>Etherlike Statistics</i>	
Alignment Errors	The number of alignment errors (missynchronized data packets).
Late Collisions	The number of times that a collision is detected later than 512 bit-times into the transmission of a packet.
FCS Errors	A count of frames received on a particular interface that are an integral number of octets in length but do not pass the FCS check. This count does not include frames received with frame-too-long or frame-too-short error.
Excessive Collisions	A count of frames for which transmission on a particular interface fails due to excessive collisions. This counter does not increment when the interface is operating in full-duplex mode.
Single Collision Frames	The number of successfully transmitted frames for which transmission is inhibited by exactly one collision.
Internal MAC Transmit Errors	A count of frames for which transmission on a particular interface fails due to an internal MAC sublayer transmit error.
Multiple Collision Frames	A count of successfully transmitted frames for which transmission is inhibited by more than one collision.
Carrier Sense Errors	The number of times that the carrier sense condition was lost or never asserted when attempting to transmit a frame.
SQE Test Errors	A count of times that the SQE TEST ERROR message is generated by the PLS sublayer for a particular interface.
Frames Too Long	A count of frames received on a particular interface that exceed the maximum permitted frame size.
Deferred Transmissions	A count of frames for which the first transmission attempt on a particular interface is delayed because the medium was busy.
Internal MAC Receive Errors	A count of frames for which reception on a particular interface fails due to an internal MAC sublayer receive error.
<i>RMON Statistics</i>	
Drop Events	The total number of events in which packets were dropped due to lack of resources.
Jabbers	The total number of frames received that were longer than 1518 octets (excluding framing bits, but including FCS octets), and had either an FCS or alignment error.
Received Bytes	Total number of bytes of data received on the network. This statistic can be used as a reasonable indication of Ethernet utilization.
Collisions	The best estimate of the total number of collisions on this Ethernet segment.

**Table 3-11 Port Statistics** (Continued)

Parameter	Description
Received Frames	The total number of frames (bad, broadcast and multicast) received.
Broadcast Frames	The total number of good frames received that were directed to the broadcast address. Note that this does not include multicast packets.
Multicast Frames	The total number of good frames received that were directed to this multicast address.
CRC/Alignment Errors	The number of CRC/alignment errors (FCS or alignment errors).
Undersize Frames	The total number of frames received that were less than 64 octets long (excluding framing bits, but including FCS octets) and were otherwise well formed.
Oversize Frames	The total number of frames received that were longer than 1518 octets (excluding framing bits, but including FCS octets) and were otherwise well formed.
Fragments	The total number of frames received that were less than 64 octets in length (excluding framing bits, but including FCS octets) and had either an FCS or alignment error.
64 Bytes Frames	The total number of frames (including bad packets) received and transmitted that were 64 octets in length (excluding framing bits but including FCS octets).
65-127 Byte Frames 128-255 Byte Frames 256-511 Byte Frames 512-1023 Byte Frames 1024-1518 Byte Frames 1519-1536 Byte Frames	The total number of frames (including bad packets) received and transmitted where the number of octets fall within the specified range (excluding framing bits but including FCS octets).

### 3 Configuring the Switch

**Web** – Click Port, Port Statistics. Select the required interface, and click Query. You can also use the Refresh button at the bottom of the page to update the screen.

#### Port Statistics

Interface  Port 1  Trunk

Query

**Interface Statistics:**

Received Octets	15020	Received Unicast Packets	0
Received Multicast Packets	177	Received Broadcast Packets	0
Received Discarded Packets	0	Received Unknown Packets	0
Received Errors	0	Transmit Octets	168087
Transmit Unicast Packets	0	Transmit Multicast Packets	2420
Transmit Broadcast Packets	47	Transmit Discarded Packets	0
Transmit Errors	0		

**Etherlike Statistics:**

Alignment Errors	0	Late Collisions	0
FCS Errors	0	Excessive Collisions	0
Single Collision Frames	0	Internal MAC Transmit Errors	0
Multiple Collision Frames	0	Carrier Sense Errors	0
SQE Test Errors	0	Frames Too Long	0
Deferred Transmissions	0	Internal MAC Receive Errors	0

**RMON Statistics:**

Drop Events	0	Jabbers	0
Received Bytes	188155	Collisions	0
Received Frames	0	64 Bytes Frames	2249
Broadcast Frames	47	65-127 Bytes Frames	459
Multicast Frames	2672	128-255 Bytes Frames	11
CRC/Alignment Errors	0	256-511 Bytes Frames	0
Undersize Frames	0	512-1023 Bytes Frames	0
Oversize Frames	0	1024-1518 Bytes Frames	0
Fragments	0		

Refresh

Figure 3-90 Port Statistics

**CLI** – This example shows statistics for port 13.

```
Console#show interfaces counters ethernet 1/13 4-198
Ethernet 1/13
  Iftable stats:
    Octets input: 868453, Octets output: 3492122
    Unicast input: 7315, Unitcast output: 6658
    Discard input: 0, Discard output: 0
    Error input: 0, Error output: 0
    Unknown protos input: 0, QLen output: 0
  Extended iftable stats:
    Multi-cast input: 0, Multi-cast output: 17027
    Broadcast input: 231, Broadcast output: 7
  Ether-like stats:
    Alignment errors: 0, FCS errors: 0
    Single Collision frames: 0, Multiple collision frames: 0
    SQE Test errors: 0, Deferred transmissions: 0
    Late collisions: 0, Excessive collisions: 0
    Internal mac transmit errors: 0, Internal mac receive errors: 0
    Frame too longs: 0, Carrier sense errors: 0
    Symbol errors: 0
  RMON stats:
    Drop events: 0, Octets: 4422579, Packets: 31552
    Broadcast pkts: 238, Multi-cast pkts: 17033
    Undersize pkts: 0, Oversize pkts: 0
    Fragments: 0, Jabbers: 0
    CRC align errors: 0, Collisions: 0
    Packet size <= 64 octets: 25568, Packet size 65 to 127 octets: 1616
    Packet size 128 to 255 octets: 1249, Packet size 256 to 511 octets: 1449
    Packet size 512 to 1023 octets: 802, Packet size 1024 to 1518 octets: 871
Console#
```

## Power Over Ethernet Settings

The iES4028FP switch can provide DC power to a wide range of connected devices, eliminating the need for an additional power source and cutting down on the amount of cables attached to each device. Once configured to supply power, an automatic detection process is initialized by the switch that is authenticated by a PoE signature from the connected device. Detection and authentication prevent damage to non-802.3af compliant devices.

The switch's power management enables total switch power and individual port power to be controlled within a configured power budget. Port power can be automatically turned on and off for connected devices, and a per-port power priority can be set so that the switch never exceeds its allocated power budget. When a device is connected to a switch port, its power requirements are detected by the switch before power is supplied. If the power required by a device exceeds the power budget of the port or the whole switch, power is not supplied.

Ports can be set to one of three power priority levels, critical, high, or low. To control the power supply within the switch's budget, ports set at critical or high priority have power enabled in preference to those ports set at low priority. For example, when a device is connected to a port set to critical priority, the switch supplies the required power, if necessary by dropping power to ports set for a lower priority. If power is

### 3 Configuring the Switch

dropped to some low-priority ports and later the power demands on the switch fall back within its budget, the dropped power is automatically restored.

## Switch Power Status

Use the Main Power Status page to display the Power over Ethernet settings for the switch.

### Command Attributes

- **Maximum Available Power** – The configured power budget for the switch.
- **System Operation Status** – The PoE power service provided to the switch ports.
- **Mainpower Consumption** – The amount of power being consumed by PoE devices connected to the switch.
- **Thermal Temperature**<sup>10</sup> – The internal temperature of the switch.
- **Software Version** – The version of software running on the PoE controller subsystem in the switch.

**Web** – Click PoE, Power Status.

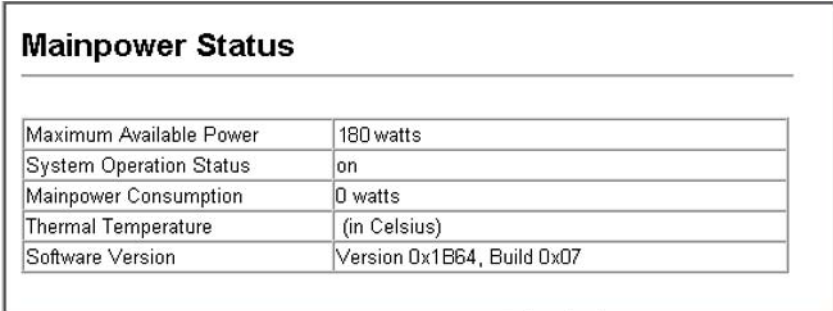

Mainpower Status	
Maximum Available Power	180 watts
System Operation Status	on
Mainpower Consumption	0 watts
Thermal Temperature	(in Celsius)
Software Version	Version 0x1B64, Build 0x07

Figure 3-91 Displaying the Global PoE Status

**CLI** – This example displays the current power status for the switch.

```
Console#show power mainpower 4-217
Unit 1 Mainpower Status
Maximum Available Power : 180 watts
System Operation Status : on
Mainpower Consumption   : 0 watts
Software Version        : Version 0x1B64, Build 0x07
Console#
```

10. This parameter is not supported for the current hardware.



## Setting a Switch Power Budget

A maximum PoE power budget for the switch (power available to all switch ports) can be defined so that power can be centrally managed, preventing overload conditions at the power source. If the power demand from devices connected to the switch exceeds the power budget setting, the switch uses port power priority settings to limit the supplied power.

### Command Attributes

**Power Allocation** – The power budget for the switch. If devices connected to the switch require more power than the switch budget, the port power priority settings are used to control the supplied power. (Range: 37 - 180 watts; Default: 180 Watts)

**Web** – Click PoE, Power Config. Specify the desired power budget for the switch. Click Apply.



The screenshot shows a web interface titled "Power Configuration". Below the title is a horizontal line. Underneath, there is a text input field labeled "Power Allocation(37-180)" with the value "180" entered and the unit "watts" to its right.

Figure 3-92 Setting the Switch Power Budget

**CLI** – This example sets the PoE power budget for the switch to the maximum level.

```
Console(config)#power mainpower maximum allocation 180      4-213
Console(config)#
```

## Displaying Port Power Status

Use the Power Port Status page to display the current PoE power status for all ports.

### Command Attributes

- **Port** – The port number.
- **Admin Status** – The administrative status of PoE power on the port.
- **Mode** – The current operating status of PoE power on the port.
- **Power Allocation** – The configured power budget for the port.
- **Power Consumption** – The current power consumption on the port.
- **Priority** – The port's configured power priority setting.

### 3 Configuring the Switch

**Web** – Click PoE, Power Port Status.

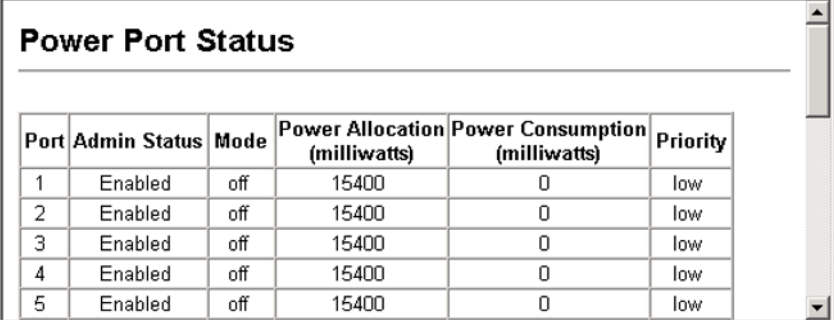

The screenshot shows a web browser window with the title "Power Port Status". Below the title is a table with the following data:

Port	Admin Status	Mode	Power Allocation (milliwatts)	Power Consumption (milliwatts)	Priority
1	Enabled	off	15400	0	low
2	Enabled	off	15400	0	low
3	Enabled	off	15400	0	low
4	Enabled	off	15400	0	low
5	Enabled	off	15400	0	low

Figure 3-93 Displaying Port PoE Status

**CLI** – This example displays the PoE status and priority of port 1.

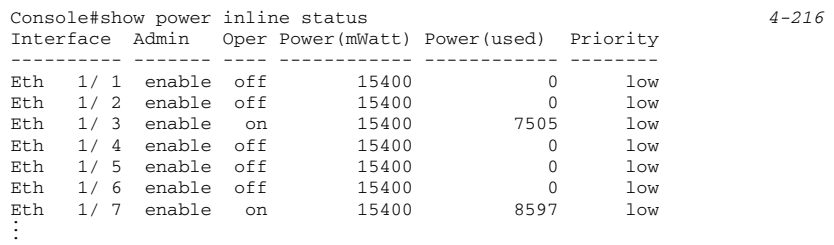

The screenshot shows a CLI session with the command "Console#show power inline status" and its output. The output is a table with the following data:

```
Console#show power inline status 4-216
Interface Admin Oper Power(mWatt) Power(used) Priority
-----
Eth 1/ 1 enable off 15400 0 low
Eth 1/ 2 enable off 15400 0 low
Eth 1/ 3 enable on 15400 7505 low
Eth 1/ 4 enable off 15400 0 low
Eth 1/ 5 enable off 15400 0 low
Eth 1/ 6 enable off 15400 0 low
Eth 1/ 7 enable on 15400 8597 low
:
```

## Configuring Port PoE Power

If a device is connected to a switch port and the switch detects that it requires more than the power budget of the port, no power is supplied to the device (i.e., port power remains off).

If the power demand from devices connected to switch ports exceeds the power budget set for the switch, the port power priority settings are used to control the supplied power. For example:

- If a device is connected to a low-priority port and causes the switch to exceed its budget, port power is not turned on.
- If a device is connected to a critical or high-priority port and causes the switch to exceed its budget, port power is turned on, but the switch drops power to one or more lower-priority ports.

**Note:** Power is dropped from low-priority ports in sequence starting from port number 1.

### Command Attributes

- **Port** – The port number on the switch.
- **Admin Status** – Enables PoE power on the port. Power is automatically supplied when a device is detected on the port, providing that the power demanded does not exceed the switch or port power budget. (Default: Enabled)
- **Priority** – Sets the power priority for the port. (Options: low, high, or critical; Default: low)
- **Power Allocation** – Sets the power budget for the port. (Range: 3000- 15400 milliwatts; Default: 15400 milliwatts)

**Web** – Click PoE, Power Port Configuration. Enable PoE power on selected ports, set the priority and the power budget, and then click Apply.

### Power Port Configuration

Port	Admin Status	Priority	Power Allocation (3000-15400 milliwatts)	Trunk
1	<input checked="" type="checkbox"/> Enabled	low	15400	
2	<input checked="" type="checkbox"/> Enabled	critical	15400	
3	<input checked="" type="checkbox"/> Enabled	low	15400	
4	<input checked="" type="checkbox"/> Enabled	high	15400	
5	<input checked="" type="checkbox"/> Enabled	high	15400	

Figure 3-94 Configuring Port PoE Power

**CLI** – This example sets the PoE power budget for port 1 to 8 watts, the priority to high (2), and then enables the power.

```

Console(config)#interface ethernet 1/1                               4-187
Console(config-if)#power inline maximum allocation 8000            4-215
Console(config-if)#power inline priority 2                          4-215
Console(config-if)#power inline                                    4-214
Console(config-if)#

```

## Address Table Settings

Switches store the addresses for all known devices. This information is used to pass traffic directly between the inbound and outbound ports. All the addresses learned by monitoring traffic are stored in the dynamic address table. You can also manually configure static addresses that are bound to a specific port.

### Setting Static Addresses

A static address can be assigned to a specific interface on this switch. Static addresses are bound to the assigned interface and will not be moved. When a static address is seen on another interface, the address will be ignored and will not be written to the address table.

#### Command Attributes

- **Static Address Counts**<sup>11</sup> – The number of manually configured addresses.
- **Current Static Address Table** – Lists all the static addresses.
- **Interface** – Port or trunk associated with the device assigned a static address.
- **MAC Address** – Physical address of a device mapped to this interface.
- **VLAN** – ID of configured VLAN (1-4093).

**Web** – Click Address Table, Static Addresses. Specify the interface, the MAC address and VLAN, then click Add Static Address.

Static Addresses	
Static Address Counts	1
Current Static Address Table	00-E0-29-94-34-DE, VLAN 1, Unit 1, Port 1, Permanent
Interface	<input checked="" type="radio"/> Port 1 <input type="radio"/> Trunk
MAC Address (XX-XX-XX-XX-XX-XX)	
VLAN	1
<input type="button" value="Add Static Address"/> <input type="button" value="Remove Static Address"/>	

Figure 3-95 Configuring a Static Address Table

11. Web only.

**CLI** – This example adds an address to the static address table, but sets it to be deleted when the switch is reset.

```
Console(config)#mac-address-table static 00-12-cf-94-34-de
interface ethernet 1/1 vlan 1 delete-on-reset
Console(config)#
```

## Displaying the Address Table

The Dynamic Address Table contains the MAC addresses learned by monitoring the source address for traffic entering the switch. When the destination address for inbound traffic is found in the database, the packets intended for that address are forwarded directly to the associated port. Otherwise, the traffic is flooded to all ports.

### Command Attributes

- **Interface** – Indicates a port or trunk.
- **MAC Address** – Physical address associated with this interface.
- **VLAN** – ID of configured VLAN (1-4094).
- **Address Table Sort Key** – You can sort the information displayed based on MAC address, VLAN or interface (port or trunk).
- **Dynamic Address Counts** – The number of addresses dynamically learned.
- **Current Dynamic Address Table** – Lists all the dynamic addresses.

**Web** – Click Address Table, Dynamic Addresses. Specify the search type (i.e., mark the Interface, MAC Address, or VLAN checkbox), select the method of sorting the displayed addresses, and then click Query.

### Dynamic Addresses

---

**Query by:**

<input type="checkbox"/> Interface	<input checked="" type="radio"/> Port	<input type="text" value="1"/>	<input type="radio"/> Trunk	<input type="text"/>
<input type="checkbox"/> MAC Address	<input type="text"/>			
<input type="checkbox"/> VLAN	<input type="text" value="1"/>			
Address Table Sort Key	<input type="text" value="Address"/>			

Dynamic Address Table		
Dynamic Address Counts	<input type="text" value="1"/>	
Current Dynamic Address Table	<table border="1" style="width: 100%; border-collapse: collapse;"> <tr> <td style="padding: 5px;">00-01-80-4B-82-93.VLAN 1,Unit 1, Port 1, Dynamic</td> </tr> </table>	00-01-80-4B-82-93.VLAN 1,Unit 1, Port 1, Dynamic
00-01-80-4B-82-93.VLAN 1,Unit 1, Port 1, Dynamic		

Figure 3-96 Configuring a Dynamic Address Table

### 3 Configuring the Switch

**CLI** – This example also displays the address table entries for port 1.

```
Console#show mac-address-table interface ethernet 1/1 4-223
Interface Mac Address      Vlan Type
-----
Eth 1/ 1 00-12-CF-48-82-93  1 Delete-on-reset
Eth 1/ 1 00-12-CF-94-34-DE  2 Learned
Console#
```

## Changing the Aging Time

You can set the aging time for entries in the dynamic address table.

### Command Attributes

- **Aging Status** – Enables/disables the function. (Default: Enabled)
- **Aging Time** – The time after which a learned entry is discarded. (Range: 10-630 seconds; Default: 300 seconds)

**Web** – Click Address Table, Address Aging. Specify the new aging time, click Apply.

### Address Aging

---

Aging Status	<input checked="" type="checkbox"/> Enabled
Aging Time (10-630):	<input type="text" value="300"/> seconds

**Figure 3-97 Setting the Address Aging Time**

**CLI** – This example sets the aging time to 300 seconds.

```
Console(config)#mac-address-table aging-time 300 4-224
Console(config)#
```

## Spanning Tree Algorithm Configuration

The Spanning Tree Algorithm (STA) can be used to detect and disable network loops, and to provide backup links between switches, bridges or routers. This allows the switch to interact with other bridging devices (that is, an STA-compliant switch, bridge or router) in your network to ensure that only one route exists between any two stations on the network, and provide backup links which automatically take over when a primary link goes down.

The spanning tree algorithms supported by this switch include these versions:

- STP – Spanning Tree Protocol (IEEE 802.1D)
- RSTP – Rapid Spanning Tree Protocol (IEEE 802.1w)
- MSTP – Multiple Spanning Tree Protocol (IEEE 802.1s)

**STP** – STP uses a distributed algorithm to select a bridging device (STP-compliant switch, bridge or router) that serves as the root of the spanning tree network. It selects a root port on each bridging device (except for the root device) which incurs the lowest path cost when forwarding a packet from that device to the root device. Then it selects a designated bridging device from each LAN which incurs the lowest path cost when forwarding a packet from that LAN to the root device. All ports connected to designated bridging devices are assigned as designated ports. After determining the lowest cost spanning tree, it enables all root ports and designated ports, and disables all other ports. Network packets are therefore only forwarded between root ports and designated ports, eliminating any possible network loops.

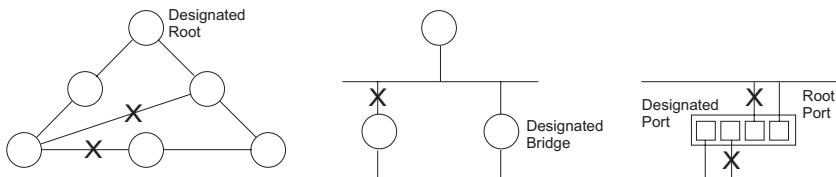

Once a stable network topology has been established, all bridges listen for Hello BPDUs (Bridge Protocol Data Units) transmitted from the Root Bridge. If a bridge does not get a Hello BPDU after a predefined interval (Maximum Age), the bridge assumes that the link to the Root Bridge is down. This bridge will then initiate negotiations with other bridges to reconfigure the network to reestablish a valid network topology.

**RSTP** – RSTP is designed as a general replacement for the slower, legacy STP. RSTP is also incorporated into MSTP. RSTP achieves much faster reconfiguration (i.e., around 1 to 3 seconds, compared to 30 seconds or more for STP) by reducing the number of state changes before active ports start learning, predefining an alternate route that can be used when a node or port fails, and retaining the forwarding database for ports insensitive to changes in the tree structure when reconfiguration occurs.

### 3 Configuring the Switch

**MSTP** – When using STP or RSTP, it may be difficult to maintain a stable path between all VLAN members. Frequent changes in the tree structure can easily isolate some of the group members. MSTP (which is based on RSTP for fast convergence) is designed to support independent spanning trees based on VLAN groups. Using multiple spanning trees can provide multiple forwarding paths and enable load balancing. One or more VLANs can be grouped into a Multiple Spanning Tree Instance (MSTI). MSTP builds a separate Multiple Spanning Tree (MST) for each instance to maintain connectivity among each of the assigned VLAN groups. MSTP then builds an Internal Spanning Tree (IST) for the Region containing all commonly configured MSTP bridges.

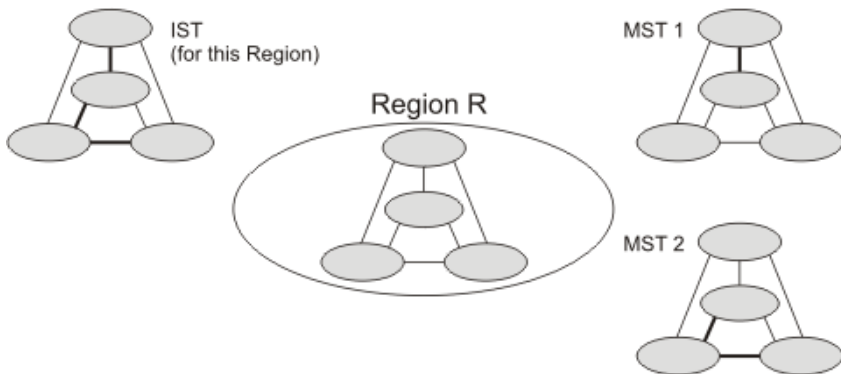

An MST Region consists of a group of interconnected bridges that have the same MST Configuration Identifiers (including the Region Name, Revision Level and Configuration Digest – see “Configuring Multiple Spanning Trees” on page 3-177). An MST Region may contain multiple MSTP Instances. An Internal Spanning Tree (IST) is used to connect all the MSTP switches within an MST region. A Common Spanning Tree (CST) interconnects all adjacent MST Regions, and acts as a virtual bridge node for communications with STP or RSTP nodes in the global network.

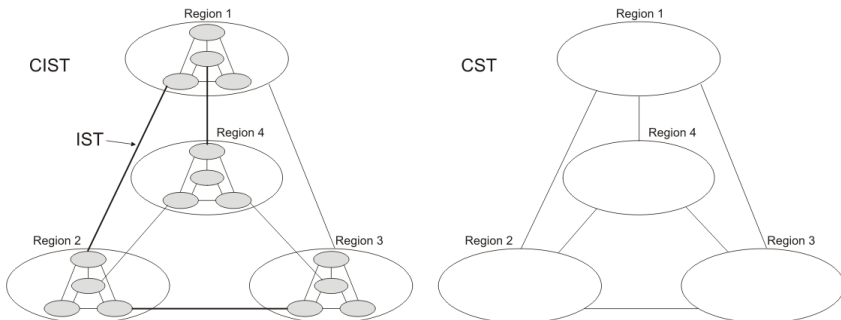

MSTP connects all bridges and LAN segments with a single Common and Internal Spanning Tree (CIST). The CIST is formed as a result of the running spanning tree algorithm between switches that support the STP, RSTP, MSTP protocols.



## Configuring Port and Trunk Loopback Detection

When Port Loopback Detection is enabled and a port receives its own BPDU, the detection agent drops the loopback BPDU, sends an SNMP trap, and places the port in discarding mode. This loopback state can be released manually or automatically. If the port is configured for automatic loopback release, then the port will only be returned to the forwarding state if one of the following conditions is satisfied:

- The port receives any other BPDU except for its own, or;
- The port's link status changes to link down and then link up again, or;
- The port ceases to receive its own BPDUs in a forward delay interval.

- Notes:**
1. If Port Loopback Detection is not enabled and a port receives its own BPDU, then the port will drop the loopback BPDU according to IEEE Standard 802.1w-2001 9.3.4 (Note 1).
  2. Port Loopback Detection will not be active if Spanning Tree is disabled on the switch.
  3. When configured for manual release mode, then a link down / up event will not release the port from the discarding state.

### Field Attributes

- **Port** – Indicates the interface to be configured.
- **Status** – Enables Loopback Detection on this interface. (Default: Enabled)
- **Trap** – Enables SNMP trap notification for loopback events on this port. (Default: Disabled)
- **Release Mode** – Configures the port for automatic or manual loopback release mode. (Default: Auto)
- **Release** – Allows a port to be manually released from discard mode. This is only available if the port is configured for manual release mode.
- **Trunk** – Indicates if this port is a trunk member.

**Web** – Click Spanning Tree, Port Loopback Detection or Trunk Loopback Detection. Modify the required attributes, then click Apply.

Port Loopback Detection					
Port	Status	Trap	Release Mode	Release	Trunk
1	<input type="checkbox"/> Enabled	<input type="checkbox"/> Enabled	Auto	Release	
2	<input checked="" type="checkbox"/> Enabled	<input checked="" type="checkbox"/> Enabled	Auto	Release	
3	<input checked="" type="checkbox"/> Enabled	<input checked="" type="checkbox"/> Enabled	Auto	Release	
4	<input checked="" type="checkbox"/> Enabled	<input checked="" type="checkbox"/> Enabled	Manual	Release	
5	<input checked="" type="checkbox"/> Enabled	<input checked="" type="checkbox"/> Enabled	Manual	Release	
6	<input checked="" type="checkbox"/> Enabled	<input type="checkbox"/> Enabled	Auto	Release	
7	<input checked="" type="checkbox"/> Enabled	<input type="checkbox"/> Enabled	Auto	Release	
8	<input checked="" type="checkbox"/> Enabled	<input type="checkbox"/> Enabled	Auto	Release	
9	<input checked="" type="checkbox"/> Enabled	<input type="checkbox"/> Enabled	Auto	Release	

Figure 3-98 Configuring Port Loopback Detection

### 3 Configuring the Switch

**CLI** – This command enables loopback detection for port 1/5, configures automatic release-mode, and enables SNMP trap notification for detected loopback BPDU's.

```
Console(config)#interface ethernet 1/5                4-187
Console(config-if)#spanning-tree loopback-detection   4-241
Console(config-if)#spanning-tree loopback-detection release-mode auto4-241
Console(config-if)#spanning-tree loopback-detection trap                4-242
```

## Displaying Global Settings

You can display a summary of the current bridge STA information that applies to the entire switch using the STA Information screen.

### Field Attributes

- **Spanning Tree State** – Shows if the switch is enabled to participate in an STA-compliant network.
- **Bridge ID** – A unique identifier for this bridge, consisting of the bridge priority, the MST Instance ID 0 for the Common Spanning Tree when spanning tree mode is set to MSTP (page 3-167), and MAC address (where the address is taken from the switch system).
- **Max Age** – The maximum time (in seconds) a device can wait without receiving a configuration message before attempting to reconfigure. All device ports (except for designated ports) should receive configuration messages at regular intervals. Any port that ages out STA information (provided in the last configuration message) becomes the designated port for the attached LAN. If it is a root port, a new root port is selected from among the device ports attached to the network. (References to “ports” in this section mean “interfaces,” which includes both ports and trunks.)
- **Hello Time** – Interval (in seconds) at which the root device transmits a configuration message.
- **Forward Delay** – The maximum time (in seconds) the root device will wait before changing states (i.e., discarding to learning to forwarding). This delay is required because every device must receive information about topology changes before it starts to forward frames. In addition, each port needs time to listen for conflicting information that would make it return to a discarding state; otherwise, temporary data loops might result.
- **Designated Root** – The priority and MAC address of the device in the Spanning Tree that this switch has accepted as the root device.
  - **Root Port** – The number of the port on this switch that is closest to the root. This switch communicates with the root device through this port. If there is no root port, then this switch has been accepted as the root device of the Spanning Tree network.
  - **Root Path Cost** – The path cost from the root port on this switch to the root device.
- **Configuration Changes** – The number of times the Spanning Tree has been reconfigured.
- **Last Topology Change** – Time since the Spanning Tree was last reconfigured.

These additional parameters are only displayed for the CLI:

- **Spanning Tree Mode** – Specifies the type of spanning tree used on this switch:
  - **STP**: Spanning Tree Protocol (IEEE 802.1D)
  - **RSTP**: Rapid Spanning Tree (IEEE 802.1w)
  - **MSTP**: Multiple Spanning Tree (IEEE 802.1s)
- **Instance** – Instance identifier of this spanning tree. (This is always 0 for the CIST.)
- **VLANs Configuration** – VLANs assigned to the CIST.
- **Priority** – Bridge priority is used in selecting the root device, root port, and designated port. The device with the highest priority becomes the STA root device. However, if all devices have the same priority, the device with the lowest MAC address will then become the root device.
- **Root Hello Time** – Interval (in seconds) at which this device transmits a configuration message.
- **Root Maximum Age** – The maximum time (in seconds) this device can wait without receiving a configuration message before attempting to reconfigure. All device ports (except for designated ports) should receive configuration messages at regular intervals. If the root port ages out STA information (provided in the last configuration message), a new root port is selected from among the device ports attached to the network. (References to “ports” in this section means “interfaces,” which includes both ports and trunks.)
- **Root Forward Delay** – The maximum time (in seconds) this device will wait before changing states (i.e., discarding to learning to forwarding). This delay is required because every device must receive information about topology changes before it starts to forward frames. In addition, each port needs time to listen for conflicting information that would make it return to a discarding state; otherwise, temporary data loops might result.
- **Max Hops** – The max number of hop counts for the MST region.
- **Remaining Hops** – The remaining number of hop counts for the MST instance.
- **Transmission limit** – The minimum interval between the transmission of consecutive RSTP/MSTP BPDUs.
- **Path Cost Method** – The path cost is used to determine the best path between devices. The path cost method is used to determine the range of values that can be assigned to each interface.
- **Flooding Behavior** – Shows if the system is configured to flood BPDUs to all other ports on the switch or just to all other ports in the same VLAN when spanning tree is disabled globally on the switch or disabled on a specific port.

**Web** – Click Spanning Tree, STA, Information.

#### STA Information

##### Spanning Tree:

Spanning Tree State	Enabled	Designated Root	32768.0012CF0B0D00
Bridge ID	32768.0012CF0B0D00	Root Port	0
Max Age	20	Root Path Cost	0
Hello Time	2	Configuration Changes	1
Forward Delay	15	Last Topology Change	0 d 0 h 16 min 23 s

**Figure 3-99** Displaying Spanning Tree Information

**CLI** – This command displays global STA settings, followed by settings for each port.

```

Console#show spanning-tree 4-245
Spanning-tree information
-----
Spanning Tree Mode:                RSTP
Spanning Tree Enabled/Disabled:    Enabled
Instance:                          0
VLANs Configuration:              1-4094
Priority:                           32768
Bridge Hello Time (sec.):          2
Bridge Max Age (sec.):             20
Bridge Forward Delay (sec.):       15
Root Hello Time (sec.):            2
Root Max Age (sec.):               20
Root Forward Delay (sec.):         15
Max Hops:                          20
Remaining Hops:                   20
Designated Root:                   32768.0013F7D37E60
Current Root Port:                 54
Current Root Cost:                 5000
Number of Topology Changes:        12
Last Topology Change Time (sec.):  4738
Transmission Limit:                3
Path Cost Method:                  Long
Flooding Behavior:                  To VLAN
:

```

**Note:** The current root port and current root cost display as zero when this device is not connected to the network.

## Configuring Global Settings

Global settings apply to the entire switch.

### Command Usage

- Spanning Tree Protocol<sup>12</sup>

Uses RSTP for the internal state machine, but sends only 802.1D BPDUs. This creates one spanning tree instance for the entire network. If multiple VLANs are implemented on a network, the path between specific VLAN members may be inadvertently disabled to prevent network loops, thus isolating group members. When operating multiple VLANs, we recommend selecting the MSTP option.

- Rapid Spanning Tree Protocol<sup>12</sup>

RSTP supports connections to either STP or RSTP nodes by monitoring the incoming protocol messages and dynamically adjusting the type of protocol messages the RSTP node transmits, as described below:

- STP Mode – If the switch receives an 802.1D BPDU (i.e., STP BPDU) after a port's migration delay timer expires, the switch assumes it is connected to an 802.1D bridge and starts using only 802.1D BPDUs.
- RSTP Mode – If RSTP is using 802.1D BPDUs on a port and receives an RSTP BPDU after the migration delay expires, RSTP restarts the migration delay timer and begins using RSTP BPDUs on that port.

- Multiple Spanning Tree Protocol

- To allow multiple spanning trees to operate over the network, you must configure a related set of bridges with the same MSTP configuration, allowing them to participate in a specific set of spanning tree instances.
- A spanning tree instance can exist only on bridges that have compatible VLAN instance assignments.
- Be careful when switching between spanning tree modes. Changing modes stops all spanning-tree instances for the previous mode and restarts the system in the new mode, temporarily disrupting user traffic.

### Command Attributes

#### *Basic Configuration of Global Settings*

- **Spanning Tree State** – Enables/disables STA on this switch. (Default: Enabled)
- **Spanning Tree Type** – Specifies the type of spanning tree used on this switch:
  - **STP**: Spanning Tree Protocol (IEEE 802.1D); i.e., when this option is selected, the switch will use RSTP set to STP forced compatibility mode).
  - **RSTP**: Rapid Spanning Tree (IEEE 802.1w); RSTP is the default.
  - **MSTP**: Multiple Spanning Tree (IEEE 802.1s);
- **Priority** – Bridge priority is used in selecting the root device, root port, and designated port. The device with the highest priority becomes the STA root device. However, if all devices have the same priority, the device with the lowest MAC

---

12. STP and RSTP BPDUs are transmitted as untagged frames, and will cross any VLAN boundaries.

### 3 Configuring the Switch

address will then become the root device. (Note that lower numeric values indicate higher priority.)

- Default: 32768
- Range: 0-61440, in steps of 4096
- Options: 0, 4096, 8192, 12288, 16384, 20480, 24576, 28672, 32768, 36864, 40960, 45056, 49152, 53248, 57344, 61440
- **Spanning Tree BPDU Flooding** – Configures the system to flood BPDUs to all other ports on the switch or just to all other ports in the same VLAN when spanning tree is disabled globally on the switch or disabled on a specific port.
  - To VLAN: Floods BPDUs to all other ports within the receiving port's native VLAN (i.e., as determined by port's PVID). This is the default.
  - To All: Floods BPDUs to all other ports on the switch.

The setting has no effect if BPDU flooding is disabled on a port (see “Configuring Interface Settings” on page 3-174).

#### *Root Device Configuration*

- **Hello Time** – Interval (in seconds) at which the root device transmits a configuration message.
  - Default: 2
  - Minimum: 1
  - Maximum: The lower of 10 or  $[(\text{Max. Message Age} / 2) - 1]$
- **Maximum Age** – The maximum time (in seconds) a device can wait without receiving a configuration message before attempting to reconfigure. All device ports (except for designated ports) should receive configuration messages at regular intervals. Any port that ages out STA information (provided in the last configuration message) becomes the designated port for the attached LAN. If it is a root port, a new root port is selected from among the device ports attached to the network. (References to “ports” in this section mean “interfaces,” which includes both ports and trunks.)
  - Default: 20
  - Minimum: The higher of 6 or  $[2 \times (\text{Hello Time} + 1)]$ .
  - Maximum: The lower of 40 or  $[2 \times (\text{Forward Delay} - 1)]$
- **Forward Delay** – The maximum time (in seconds) this device will wait before changing states (i.e., discarding to learning to forwarding). This delay is required because every device must receive information about topology changes before it starts to forward frames. In addition, each port needs time to listen for conflicting information that would make it return to a discarding state; otherwise, temporary data loops might result.
  - Default: 15
  - Minimum: The higher of 4 or  $[(\text{Max. Message Age} / 2) + 1]$
  - Maximum: 30

### *Configuration Settings for RSTP*

The following attributes apply to both RSTP and MSTP:

- **Path Cost Method** – The path cost is used to determine the best path between devices. The path cost method is used to determine the range of values that can be assigned to each interface.
  - Long: Specifies 32-bit based values that range from 1-200,000,000. (This is the default.)
  - Short: Specifies 16-bit based values that range from 1-65535.
- **Transmission Limit** – The maximum transmission rate for BPDUs is specified by setting the minimum interval between the transmission of consecutive protocol messages. (Range: 1-10; Default: 3)

### *Configuration Settings for MSTP*

- **Max Instance Numbers** – The maximum number of MSTP instances to which this switch can be assigned.
- **Configuration Digest** – An MD5 signature key that contains the VLAN ID to MST ID mapping table. In other words, this key is a mapping of all VLANs to the CIST.
- **Region Revision**<sup>13</sup> – The revision for this MSTI. (Range: 0-65535; Default: 0)
- **Region Name**<sup>13</sup> – The name for this MSTI. (Maximum length: 32 characters; switch's MAC address)
- **Max Hop Count** – The maximum number of hops allowed in the MST region before a BPDU is discarded. (Range: 1-40; Default: 20)

---

13. The MST name and revision number are both required to uniquely identify an MST region.

### 3 Configuring the Switch

**Web** – Click Spanning Tree, STA, Configuration. Modify the required attributes, and click Apply.

#### STA Configuration

---

**Switch:**

Spanning Tree State	<input checked="" type="checkbox"/> Enabled
Spanning Tree Type	MSTP ▾
Priority (0-61440), in steps of 4096	32768
Spanning Tree BPDU Flooding	▾

---

**When the Switch Becomes Root:**

Input Format:  $2 * (\text{hello time} + 1) \leq \text{max age} \leq 2 * (\text{forward delay} - 1)$

Hello Time (1-10)	2	seconds
Maximum Age (6-40)	20	seconds
Forward Delay (4-30)	15	seconds

---

**RSTP Configuration:**

Path Cost Method	Long ▾
Transmission Limit (1-10)	3

---

**MSTP Configuration:**

Max Instance Numbers	9
Configuration Digest	0xAC36177F50283CD4B83821D8AB26DE62
Region Revision (0-65535)	0
Region Name	00 16 b6 f0 3b ec
Max Hop Count (1-40)	20

Figure 3-100 Configuring Spanning Tree



**CLI** – This example enables Spanning Tree Protocol, sets the mode to MST, and then configures the STA and MSTP parameters.

```
Console(config)#spanning-tree 4-226
Console(config)#spanning-tree mode mstp 4-227
Console(config)#spanning-tree priority 45056 4-230
Console(config)#spanning-tree hello-time 5 4-228
Console(config)#spanning-tree max-age 38 4-229
Console(config)#spanning-tree forward-time 20 4-228
Console(config)#spanning-tree pathcost method long 4-231
Console(config)#spanning-tree transmission-limit 4 4-231
Console(config)#spanning-tree mst configuration 4-232
Console(config-mstp)#revision 1 4-234
Console(config-mstp)#name R&D 4-234
Console(config-mstp)#max-hops 30 4-235
Console(config-mstp)#
```

## Displaying Interface Settings

The STA Port Information and STA Trunk Information pages display the current status of ports and trunks in the Spanning Tree.

### Field Attributes

- **Spanning Tree** – Shows if STA has been enabled on this interface.
- **BPDU Flooding** – Shows if BPDUs will be flood to other ports when spanning tree is disabled globally on the switch or disabled on a specific port.
- **STA Status** – Displays current state of this port within the Spanning Tree:
  - **Discarding** - Port receives STA configuration messages, but does not forward packets.
  - **Learning** - Port has transmitted configuration messages for an interval set by the Forward Delay parameter without receiving contradictory information. Port address table is cleared, and the port begins learning addresses.
  - **Forwarding** - Port forwards packets, and continues learning addresses.

The rules defining port status are:

- A port on a network segment with no other STA compliant bridging device is always forwarding.
- If two ports of a switch are connected to the same segment and there is no other STA device attached to this segment, the port with the smaller ID forwards packets and the other is discarding.
- All ports are discarding when the switch is booted, then some of them change state to learning, and then to forwarding.
- **Forward Transitions** – The number of times this port has transitioned from the Learning state to the Forwarding state.
- **Designated Cost** – The cost for a packet to travel from this port to the root in the current Spanning Tree configuration. The slower the media, the higher the cost.
- **Designated Bridge** – The bridge priority and MAC address of the device through which this port must communicate to reach the root of the Spanning Tree.

### 3 Configuring the Switch

- **Designated Port** – The port priority and number of the port on the designated bridging device through which this switch must communicate with the root of the Spanning Tree.
- **Oper Link Type** – The operational point-to-point status of the LAN segment attached to this interface. This parameter is determined by manual configuration or by auto-detection, as described for Admin Link Type in STA Port Configuration on page 3-174.
- **Oper Edge Port** – This parameter is initialized to the setting for Admin Edge Port in STA Port Configuration on page 3-174 (i.e., true or false), but will be set to false if a BPDU is received, indicating that another bridge is attached to this port.
- **Port Role** – Roles are assigned according to whether the port is part of the active topology connecting the bridge to the root bridge (i.e., **root port**), connecting a LAN through the bridge to the root bridge (i.e., **designated port**), or is the MSTI regional root (i.e., **master port**); or is an **alternate** or **backup port** that may provide connectivity if other bridges, bridge ports, or LANs fail or are removed. The role is set to disabled (i.e., **disabled port**) if a port has no role within the spanning tree.

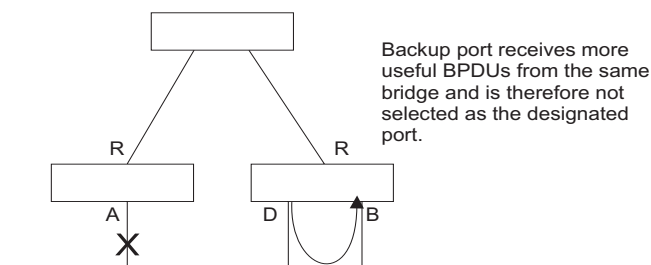
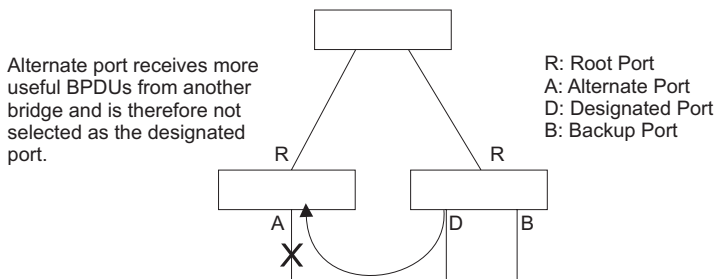

- **Trunk Member** – Indicates if a port is a member of a trunk. (STA Port Information only)

These additional parameters are only displayed for the CLI:

- **Admin Status** – Shows if this interface is enabled.
- **External Admin Path Cost** – The path cost for the IST. This parameter is used by the STA to determine the best path between devices. Therefore, lower values

should be assigned to ports attached to faster media, and higher values assigned to ports with slower media. (Path cost takes precedence over port priority.)

- **Internal Admin Path Cost** – The path cost for the MST. See the preceding item.
- **Priority** – Defines the priority used for this port in the Spanning Tree Algorithm. If the path cost for all ports on a switch is the same, the port with the highest priority (i.e., lowest value) will be configured as an active link in the Spanning Tree. This makes a port with higher priority less likely to be blocked if the Spanning Tree Algorithm is detecting network loops. Where more than one port is assigned the highest priority, the port with the lowest numeric identifier will be enabled.
- **Designated Root** – The priority and MAC address of the device in the Spanning Tree that this switch has accepted as the root device.
- **Fast Forwarding** – This field provides the same information as Admin Edge port, and is only included for backward compatibility with earlier products.
- **Admin Edge Port** – You can enable this option if an interface is attached to a LAN segment that is at the end of a bridged LAN or to an end node. Since end nodes **cannot** cause forwarding loops, they can pass directly through to the spanning tree forwarding state. Specifying Edge Ports provides quicker convergence for devices such as workstations or servers, retains the current forwarding database to reduce the amount of frame flooding required to rebuild address tables during reconfiguration events, does not cause the spanning tree to reconfigure when the interface changes state, and also overcomes other STA-related timeout problems. However, remember that Edge Port should only be enabled for ports connected to an end-node device.
- **Admin Link Type** – The link type attached to this interface.
  - Point-to-Point – A connection to exactly one other bridge.
  - Shared – A connection to two or more bridges.
  - Auto – The switch automatically determines if the interface is attached to a point-to-point link or to shared media.

**Web** – Click Spanning Tree, STA, Port Information or STA Trunk Information.

#### STA Port Information

Port	Spanning Tree	STA Status	Forward Transitions	Designated Cost	Designated Bridge	Designated Port	Oper Link Type	Oper Edge Port	Port Role	Trunk Member
1	Enabled	Forwarding	1	0	32768.0012CF0B0D00	128.1	Point-to-Point	Disabled	Designated	
2	Enabled	Discarding	0	0	32768.0012CF0B0D00	128.2	Point-to-Point	Disabled	Disabled	
3	Enabled	Discarding	0	0	32768.0012CF0B0D00	128.3	Point-to-Point	Disabled	Disabled	
4	Enabled	Discarding	0	0	32768.0012CF0B0D00	128.4	Point-to-Point	Disabled	Disabled	
5	Enabled	Discarding	0	0	32768.0012CF0B0D00	128.5	Point-to-Point	Disabled	Disabled	

Figure 3-101 Displaying Spanning Tree Port Information

### 3 Configuring the Switch

CLI – This example shows the STA attributes for port 5.

```
Console#show spanning-tree ethernet 1/5 4-245
Eth 1/ 5 information
-----
Admin Status:                Enabled
Role:                        Designate
State:                       Forwarding
External Admin Path Cost:    0
Internal Admin Path Cost:    0
External Oper Path Cost:     100000
Internal Oper Path Cost:     100000
Priority:                     128
Designated Cost:             5000
Designated Port:            128.1
Designated Root:             32768.0.0013F7D37E60
Designated Bridge:          32768.0.0016B6F0713C
Fast Forwarding:            Enabled
Forward Transitions:        1
Admin Edge Port:            Enabled
Oper Edge Port:             Enabled
Admin Link Type:            Auto
Oper Link Type:             Point-to-point
Flooding Behavior:          Enabled
Spanning Tree Status:      Enabled
Console#
```

## Configuring Interface Settings

You can configure RSTP and MSTP attributes for specific interfaces, including port priority, path cost, link type, and edge port. You may use a different priority or path cost for ports of the same media type to indicate the preferred path, link type to indicate a point-to-point connection or shared-media connection, and edge port to indicate if the attached device can support fast forwarding. (References to “ports” in this section means “interfaces,” which includes both ports and trunks.)

### Command Attributes

The following attributes are read-only and cannot be changed:

- **STA State** – Displays current state of this port within the Spanning Tree. (See Displaying Interface Settings on page 3-171 for additional information.)
  - **Discarding** - Port receives STA configuration messages, but does not forward packets.
  - **Learning** - Port has transmitted configuration messages for an interval set by the Forward Delay parameter without receiving contradictory information. Port address table is cleared, and the port begins learning addresses.
  - **Forwarding** - Port forwards packets, and continues learning addresses.
- **Trunk**<sup>14</sup> – Indicates if a port is a member of a trunk. (STA Port Configuration only)

---

14. STA Port Configuration only

The following interface attributes can be configured:

- **Spanning Tree** – Enables/disables STA on this interface. (Default: Enabled).
- **BPDU Flooding** – Enables/disables the flooding of BPDUs to other ports when global spanning tree is disabled (page 3-167) or when spanning tree is disabled on specific port. When flooding is enabled, BPDUs are flooded to all other ports on the switch or to all other ports within the receiving port's native VLAN as specified by the Spanning Tree BPDU Flooding attribute (page 3-167).
- **Priority** – Defines the priority used for this port in the Spanning Tree Protocol. If the path cost for all ports on a switch are the same, the port with the highest priority (i.e., lowest value) will be configured as an active link in the Spanning Tree. This makes a port with higher priority less likely to be blocked if the Spanning Tree Protocol is detecting network loops. Where more than one port is assigned the highest priority, the port with lowest numeric identifier will be enabled.
  - Default: 128
  - Range: 0-240, in steps of 16
- **Admin Path Cost** – This parameter is used by the STA to determine the best path between devices. Therefore, lower values should be assigned to ports attached to faster media, and higher values assigned to ports with slower media. (Path cost takes precedence over port priority.)  
(Range: 0 for auto-configuration, 1-65535 for the short path cost method<sup>15</sup>, 1-200,000,000 for the long path cost method)

By default, the system automatically detects the speed and duplex mode used on each port, and configures the path cost according to the values shown below. Path cost "0" is used to indicate auto-configuration mode. When the short path cost method is selected and the default path cost recommended by the IEEE 8021w standard exceeds 65,535, the default is set to 65,535.

**Table 3-12 Recommended STA Path Cost Range**

Port Type	IEEE 802.1D-1998	IEEE 802.1w-2001
Ethernet	50-600	200,000-20,000,000
Fast Ethernet	10-60	20,000-2,000,000
Gigabit Ethernet	3-10	2,000-200,000

**Table 3-13 Recommended STA Path Costs**

Port Type	Link Type	IEEE 802.1D-1998	IEEE 802.1w-2001
Ethernet	Half Duplex	100	2,000,000
	Full Duplex	95	1,999,999
	Trunk	90	1,000,000

15. Refer to "Configuring Global Settings" on page 3-167 for information on setting the path cost method.

**Table 3-13 Recommended STA Path Costs**

Port Type	Link Type	IEEE 802.1D-1998	IEEE 802.1w-2001
Fast Ethernet	Half Duplex	19	200,000
	Full Duplex	18	100,000
	Trunk	15	50,000
Gigabit Ethernet	Full Duplex	4	10,000
	Trunk	3	5,000

**Table 3-14 Default STA Path Costs**

Port Type	Link Type	IEEE 802.1w-2001
Ethernet	Half Duplex	2,000,000
	Full Duplex	1,000,000
	Trunk	500,000
Fast Ethernet	Half Duplex	200,000
	Full Duplex	100,000
	Trunk	50,000
Gigabit Ethernet	Full Duplex	10,000
	Trunk	5,000

- **Admin Link Type** – The link type attached to this interface.
  - Point-to-Point – A connection to exactly one other bridge.
  - Shared – A connection to two or more bridges.
  - Auto – The switch automatically determines if the interface is attached to a point-to-point link or to shared media. (This is the default setting.)
- **Admin Edge Port (Fast Forwarding)** – You can enable this option if an interface is attached to a LAN segment that is at the end of a bridged LAN or to an end node. Since end nodes **cannot** cause forwarding loops, they can pass directly through to the spanning tree forwarding state. Specifying Edge Ports provides quicker convergence for devices such as workstations or servers, retains the current forwarding database to reduce the amount of frame flooding required to rebuild address tables during reconfiguration events, does not cause the spanning tree to initiate reconfiguration when the interface changes state, and also overcomes other STA-related timeout problems. However, remember that Edge Port should only be enabled for ports connected to an end-node device. (Default: Disabled)
- **Migration** – If at any time the switch detects STP BPDUs, including Configuration or Topology Change Notification BPDUs, it will automatically set the selected interface to forced STP-compatible mode. However, you can also use the Protocol Migration button to manually re-check the appropriate BPDU format (RSTP or STP-compatible) to send on the selected interfaces. (Default: Disabled)

**Web** – Click Spanning Tree, STA, Port Configuration or Trunk Configuration. Modify the required attributes, then click Apply.

STA Port Configuration								
Port	Spanning Tree	BPDU Flooding	STA State	Priority (0-240), in steps of 16	Admin Path Cost (1-200000000, 0:Auto)	Admin Link Type	Migration	Trunk
1	<input checked="" type="checkbox"/> Enabled	<input checked="" type="checkbox"/> Enabled	Forwarding	<input type="text" value="128"/>	<input type="text" value="0"/>	Auto	<input type="checkbox"/> Enabled	
2	<input checked="" type="checkbox"/> Enabled	<input checked="" type="checkbox"/> Enabled	Discarding	<input type="text" value="128"/>	<input type="text" value="0"/>	Auto	<input type="checkbox"/> Enabled	
3	<input checked="" type="checkbox"/> Enabled	<input checked="" type="checkbox"/> Enabled	Discarding	<input type="text" value="128"/>	<input type="text" value="0"/>	Auto	<input type="checkbox"/> Enabled	
4	<input checked="" type="checkbox"/> Enabled	<input checked="" type="checkbox"/> Enabled	Discarding	<input type="text" value="128"/>	<input type="text" value="0"/>	Auto	<input type="checkbox"/> Enabled	
5	<input checked="" type="checkbox"/> Enabled	<input checked="" type="checkbox"/> Enabled	Forwarding	<input type="text" value="128"/>	<input type="text" value="0"/>	Auto	<input type="checkbox"/> Enabled	
6	<input checked="" type="checkbox"/> Enabled	<input checked="" type="checkbox"/> Enabled	Discarding	<input type="text" value="128"/>	<input type="text" value="0"/>	Auto	<input type="checkbox"/> Enabled	
7	<input checked="" type="checkbox"/> Enabled	<input type="checkbox"/> Enabled	Discarding	<input type="text" value="0"/>	<input type="text" value="50"/>	Auto	<input type="checkbox"/> Enabled	
8	<input checked="" type="checkbox"/> Enabled	<input checked="" type="checkbox"/> Enabled	Discarding	<input type="text" value="128"/>	<input type="text" value="0"/>	Auto	<input type="checkbox"/> Enabled	

Figure 3-102 Configuring Spanning Tree per Port

**CLI** – This example sets STA attributes for port 7.

```

Console(config)#interface ethernet 1/7          4-187
Console(config-if)#no spanning-tree port-bpdu-flooding 4-239
Console(config-if)#spanning-tree port-priority 0 4-237
Console(config-if)#spanning-tree cost 50       4-236
Console(config-if)#spanning-tree link-type auto 4-240
Console(config-if)#no spanning-tree edge-port 4-238
Console(config-if)#

```

## Configuring Multiple Spanning Trees

MSTP generates a unique spanning tree for each instance. This provides multiple pathways across the network, thereby balancing the traffic load, preventing wide-scale disruption when a bridge node in a single instance fails, and allowing for faster convergence of a new topology for the failed instance.

By default all VLANs are assigned to the Internal Spanning Tree (MST Instance 0) that connects all bridges and LANs within the MST region. This switch supports up to 9 instances. You should try to group VLANs which cover the same general area of your network. However, remember that you must configure all bridges within the same MSTI Region (page 3-133) with the same set of instances, and the same instance (on each bridge) with the same set of VLANs. Also, note that RSTP treats each MSTI region as a single node, connecting all regions to the Common Spanning Tree.

To use multiple spanning trees:

1. Set the spanning tree type to MSTP (STA Configuration, page 3-130).
2. Enter the spanning tree priority for the selected MST instance (MSTP VLAN Configuration).
3. Add the VLANs that will share this MSTI (MSTP VLAN Configuration). Note: All VLANs are automatically added to the IST (Instance 0).

### 3 Configuring the Switch

**Note:** All VLANs are automatically added to the IST (Instance 0).

To ensure that the MSTI maintains connectivity across the network, you must configure a related set of bridges with the same MSTI settings.

#### Command Attributes

- **MST Instance** – Instance identifier of this spanning tree. (Default: 0)
- **Priority** – The priority of a spanning tree instance. (Range: 0-61440 in steps of 4096; Options: 0, 4096, 8192, 12288, 16384, 20480, 24576, 28672, 32768, 36864, 40960, 45056, 49152, 53248, 57344, 61440; Default: 32768)
- **VLANs in MST Instance** – VLANs assigned to this instance.
- **MST ID** – Instance identifier to configure. (Range: 0-4094; Default: 0)
- **VLAN ID** – VLAN to assign to this selected MST instance. (Range: 1-4094)

The other global attributes are described under “Displaying Global Settings,” page 3-164. The attributes displayed by the CLI for individual interfaces are described under “Displaying Interface Settings,” page 3-171

**Web** – Click Spanning Tree, MSTP, VLAN Configuration. Select an instance identifier from the list, set the instance priority, and click Apply. To add the VLAN members to an MSTI instance, enter the instance identifier, the VLAN identifier, and click Add.

#### MSTP VLAN Configuration

---

MST Instance ID:

Spanning Tree State	Enabled	Designated Root	32768.000035281003
Bridge ID	32768.000035281003	Root Port	0
Max Age	20	Root Path Cost	0
Hello Time	2	Configuration Changes	0
Forward Delay	15	Last Topology Change	0 d 4 h 21 min 45 s

Priority (0-61440):

---

**MSTP VLAN Configuration:**

VLAN in MST Instance:

VLAN 1	<input type="button" value="Remove"/>
VLAN 2	
VLAN 3	
VLAN 4	
VLAN 5	

MST ID (0-4094):  VLAN ID:

Figure 3-103 Configuring Multiple Spanning Trees

**CLI** – This example sets the priority for MSTI 1, and adds VLANs 1-5 to this MSTI.

```
Console(config)#spanning-tree mst configuration      4-232
Console(config-mst)#mst 1 priority 4096           4-233
Console(config-mstp)#mst 1 vlan 1-5              4-232
Console(config-mst)#
```



**CLI** – This example sets the priority for MSTI 1, and adds VLAN 1 to this MSTI. It then displays the STA settings for instance 1, followed by settings for each port.

```

Console(config)#spanning-tree mst configuration                               4-232
Console(config-mst)#mst 1 priority 4096                                    4-233
Console(config-mstp)#mst 1 vlan 1                                         4-232
Console(config-mst)#end
Console#show spanning-tree mst 1                                          4-245
Spanning Tree Information
-----
Spanning Tree Mode:                MSTP
Spanning Tree Enabled/Disabled:    Enabled
Instance:                          0
VLANs Configuration:               1-4094
Priority:                           32768
Bridge Hello Time (sec.):          2
Bridge Max Age (sec.):             20
Bridge Forward Delay (sec.):       15
Root Hello Time (sec.):            2
Root Max Age (sec.):               20
Root Forward Delay (sec.):         15
Max Hops:                          20
Remaining Hops:                   20
Designated Root:                   32768.0.0013F7D37E60
Current Root Port:                 27
Current Root Cost:                 10000
Number of Topology Changes:        1
Last Topology Change Time (sec.):  7114
Transmission Limit:                3
Path Cost Method:                  Long
Flooding Behavior:                 To VLAN
-----

Eth 1/ 1 Information
-----
Admin Status:                      Enabled
Role:                              Designate
State:                              Forwarding
External Admin Path Cost:          0
Internal Admin Path Cost:          0
External Oper Path Cost:           100000
Internal Oper Path Cost:           100000
Priority:                           128
Designated Cost:                   10000
Designated Port:                   128.1
Designated Root:                   32768.0.0013F7D37E60
Designated Bridge:                 32768.0.0016B6F0713C
Fast Forwarding:                   Enabled
Forward Transitions:               1
Admin Edge Port:                   Enabled
Oper Edge Port:                    Enabled
Admin Link Type:                   Auto
Oper Link Type:                    Point-to-point
Flooding Behavior:                 Enabled
Spanning Tree Status:              Enabled
:
:

```

## Displaying Interface Settings for MSTP

The MSTP Port Information and MSTP Trunk Information pages display the current status of ports and trunks in the selected MST instance.

### Command Attributes

- **MST Instance ID** – Instance identifier to configure. (Default: 0)

**Note:** The other attributes are described under “Displaying Interface Settings” on page 3-171

**Web** – Click Spanning Tree, MSTP, Port or Trunk Information. Select the required MST instance to display the current spanning tree values.

MSTP Port Information											
MST Instance ID: <input type="text" value="0"/>											
Port	STA Status	Forward Transitions	Cost	Designated Bridge	Designated Port	Oper Path Cost	Oper Link Type	Oper Edge Port	Port Role	Trunk Member	
1	Forwarding	1	10000	32768.0.0016B6F0713C	128.1	100000	Point-to-Point	Enabled	Designated		
2	Discarding	0	10000	32768.0.0016B6F0713C	128.2	2000000	Shared	Enabled	Disabled		
3	Discarding	0	10000	32768.0.0016B6F0713C	128.3	2000000	Shared	Enabled	Disabled		
4	Discarding	0	10000	32768.0.0016B6F0713C	128.4	2000000	Shared	Enabled	Disabled		
5	Forwarding	1	10000	32768.0.0016B6F0713C	128.5	100000	Point-to-Point	Enabled	Designated		
6	Discarding	0	10000	32768.0.0016B6F0713C	128.6	2000000	Shared	Enabled	Disabled		
7	Discarding	0	10000	32768.0.0016B6F0713C	128.7	2000000	Shared	Enabled	Disabled		
8	Discarding	0	10000	32768.0.0016B6F0713C	128.8	2000000	Shared	Enabled	Disabled		
9	Discarding	0	10000	32768.0.0016B6F0713C	128.9	2000000	Shared	Enabled	Disabled		
10	Discarding	0	10000	32768.0.0016B6F0713C	128.10	2000000	Shared	Enabled	Disabled		
11	Discarding	0	10000	32768.0.0016B6F0713C	128.11	2000000	Shared	Enabled	Disabled		
12	Discarding	0	10000	32768.0.0016B6F0713C	128.12	2000000	Shared	Enabled	Disabled		

Figure 3-104 Displaying MSTP Interface Settings

**CLI** – This displays STA settings for instance 0, followed by settings for each port. The settings for instance 0 are global settings that apply to the IST, the settings for other instances only apply to the local spanning tree.

```

Console#show spanning-tree mst 0                                     4-245
Spanning Tree Information
-----
Spanning Tree Mode:                MSTP
Spanning Tree Enabled/Disabled:    Enabled
Instance:                          0
VLANs Configuration:              1-4094
Priority:                           32768
Bridge Hello Time (sec.):          2
Bridge Max Age (sec.):             20
Bridge Forward Delay (sec.):       15
Root Hello Time (sec.):            2
Root Max Age (sec.):               20
Root Forward Delay (sec.):         15
Max Hops:                          20
Remaining Hops:                   20
Designated Root:                   32768.0.0013F7D37E60
Current Root Port:                 27
Current Root Cost:                 10000
Number of Topology Changes:        1
Last Topology Change Time (sec.):  7449
Transmission Limit:                3
Path Cost Method:                  Long
Flooding Behavior:                  To VLAN
-----
Eth 1/ 1 Information
-----
Admin Status:                      Enabled
Role:                               Designate
State:                              Forwarding
External Admin Path Cost:          0
Internal Admin Path Cost:          0
External Oper Path Cost:           100000
Internal Oper Path Cost:           100000
Priority:                           128
Designated Cost:                   10000
Designated Port:                   128.1
Designated Root:                   32768.0.0013F7D37E60
Designated Bridge:                 32768.0.0016B6F0713C
Fast Forwarding:                   Enabled
Forward Transitions:               1
Admin Edge Port:                   Enabled
Oper Edge Port:                    Enabled
Admin Link Type:                   Auto
Oper Link Type:                    Point-to-point
Flooding Behavior:                 Enabled
Spanning Tree Status:              Enabled
:
:

```

## Configuring Interface Settings for MSTP

You can configure the STA interface settings for an MST Instance using the MSTP Port Configuration and MSTP Trunk Configuration pages.

### Field Attributes

The following attributes are read-only and cannot be changed:

- **STA State** – Displays current state of this port within the Spanning Tree. (See “Displaying Interface Settings” on page 3-171 for additional information.)
  - **Discarding** – Port receives STA configuration messages, but does not forward packets.
  - **Learning** – Port has transmitted configuration messages for an interval set by the Forward Delay parameter without receiving contradictory information. Port address table is cleared, and the port begins learning addresses.
  - **Forwarding** – Port forwards packets, and continues learning addresses.
- **Trunk** – Indicates if a port is a member of a trunk. (STA Port Configuration only)

The following interface attributes can be configured:

- **MST Instance ID** – Instance identifier to configure. (Default: 0)
- **Priority** – Defines the priority used for this port in the Spanning Tree Protocol. If the path cost for all ports on a switch are the same, the port with the highest priority (i.e., lowest value) will be configured as an active link in the Spanning Tree. This makes a port with higher priority less likely to be blocked if the Spanning Tree Protocol is detecting network loops. Where more than one port is assigned the highest priority, the port with lowest numeric identifier will be enabled. (Default: 128; Range: 0-240, in steps of 16)
- **Admin MST Path Cost** – This parameter is used by the MSTP to determine the best path between devices. Therefore, lower values should be assigned to ports attached to faster media, and higher values assigned to ports with slower media. (Path cost takes precedence over port priority.) Note that when the Path Cost Method is set to short (page 3-63), the maximum path cost is 65,535.

By default, the system automatically detects the speed and duplex mode used on each port, and configures the path cost according to the values shown below. Path cost “0” is used to indicate auto-configuration mode. When the short path cost method is selected and the default path cost recommended by the IEEE 8021w standard exceeds 65,535, the default is set to 65,535

The recommended range is listed in Table 3-12 on page 3-175.

The recommended path cost is listed in Table 3-13 on page 3-175.

The default path costs are listed in Table 3-14 on page 3-176.

**Web** – Click Spanning Tree, MSTP, Port Configuration or Trunk Configuration. Enter the priority and path cost for an interface, and click Apply.

**MSTP Port Configuration**

MST Instance ID:

Port	STA State	Priority (0-240), in steps of 16	Admin MST Path Cost (1-200000000, 0:Auto)	Trunk
1	Discarding	<input type="text" value="128"/>	<input type="text" value="0"/>	<input type="checkbox"/>
2	Discarding	<input type="text" value="128"/>	<input type="text" value="0"/>	<input type="checkbox"/>
3	Discarding	<input type="text" value="128"/>	<input type="text" value="0"/>	<input type="checkbox"/>
4	Discarding	<input type="text" value="128"/>	<input type="text" value="0"/>	<input type="checkbox"/>
5	Forwarding	<input type="text" value="128"/>	<input type="text" value="0"/>	<input type="checkbox"/>
6	Discarding	<input type="text" value="128"/>	<input type="text" value="0"/>	<input type="checkbox"/>
7	Discarding	<input type="text" value="128"/>	<input type="text" value="0"/>	<input type="checkbox"/>
8	Discarding	<input type="text" value="128"/>	<input type="text" value="0"/>	<input type="checkbox"/>
9	Discarding	<input type="text" value="128"/>	<input type="text" value="0"/>	<input type="checkbox"/>

Figure 3-105 Displaying MSTP Interface Settings

**CLI** – This example sets the MSTP attributes for port 4.

```

Console(config)#interface ethernet 1/4           4-187
Console(config-if)#spanning-tree mst port-priority 0   4-244
Console(config-if)#spanning-tree mst cost 50         4-243
Console(config-if)

```

## VLAN Configuration

### IEEE 802.1Q VLANs

In large networks, routers are used to isolate broadcast traffic for each subnet into separate domains. This switch provides a similar service at Layer 2 by using VLANs to organize any group of network nodes into separate broadcast domains. VLANs confine broadcast traffic to the originating group, and can eliminate broadcast storms in large networks. This also provides a more secure and cleaner network environment.

An IEEE 802.1Q VLAN is a group of ports that can be located anywhere in the network, but communicate as though they belong to the same physical segment.

VLANs help to simplify network management by allowing you to move devices to a new VLAN without having to change any physical connections. VLANs can be easily organized to reflect departmental groups (such as Marketing or R&D), usage groups (such as e-mail), or multicast groups (used for multimedia applications such as videoconferencing).

VLANs provide greater network efficiency by reducing broadcast traffic, and allow you to make network changes without having to update IP addresses or IP subnets. VLANs inherently provide a high level of network security since traffic must pass through a configured Layer 3 link to reach a different VLAN.

### 3 Configuring the Switch

This switch supports the following VLAN features:

- Up to 255 VLANs based on the IEEE 802.1Q standard
- Distributed VLAN learning across multiple switches using explicit or implicit tagging and GVRP protocol
- Port overlapping, allowing a port to participate in multiple VLANs
- End stations can belong to multiple VLANs
- Passing traffic between VLAN-aware and VLAN-unaware devices
- Priority tagging

**Note:** The switch allows 255 user-manageable VLANs. One extra, unmanageable VLAN (VLAN ID 4093) is maintained for switch clustering.

#### Assigning Ports to VLANs

Before enabling VLANs for the switch, you must first assign each port to the VLAN group(s) in which it will participate. By default all ports are assigned to VLAN 1 as untagged ports. Add a port as a tagged port if you want it to carry traffic for one or more VLANs, and any intermediate network devices or the host at the other end of the connection supports VLANs. Then assign ports on the other VLAN-aware network devices along the path that will carry this traffic to the same VLAN(s), either manually or dynamically using GVRP. However, if you want a port on this switch to participate in one or more VLANs, but none of the intermediate network devices nor the host at the other end of the connection supports VLANs, then you should add this port to the VLAN as an untagged port.

**Note:** VLAN-tagged frames can pass through VLAN-aware or VLAN-unaware network interconnection devices, but the VLAN tags should be stripped off before passing it on to any end-node host that does not support VLAN tagging.

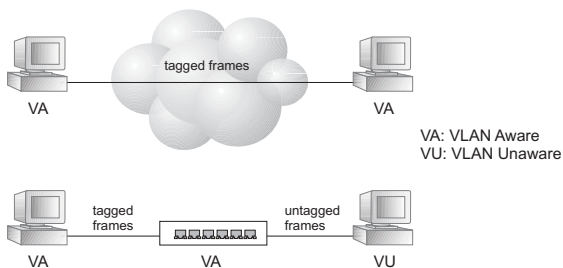

**VLAN Classification** – When the switch receives a frame, it classifies the frame in one of two ways. If the frame is untagged, the switch assigns the frame to an associated VLAN (based on the default VLAN ID of the receiving port). But if the frame is tagged, the switch uses the tagged VLAN ID to identify the port broadcast domain of the frame.

**Port Overlapping** – Port overlapping can be used to allow access to commonly shared network resources among different VLAN groups, such as file servers or printers. Note that if you implement VLANs which do not overlap, but still need to communicate, you can connect them by enabled routing on this switch.

**Untagged VLANs** – Untagged (or static) VLANs are typically used to reduce broadcast traffic and to increase security. A group of network users assigned to a VLAN form a broadcast domain that is separate from other VLANs configured on the switch. Packets are forwarded only between ports that are designated for the same VLAN. Untagged VLANs can be used to manually isolate user groups or subnets. However, you should use IEEE 802.3 tagged VLANs with GVRP whenever possible to fully automate VLAN registration.

**Automatic VLAN Registration** – GVRP (GARP VLAN Registration Protocol) defines a system whereby the switch can automatically learn the VLANs to which each end station should be assigned. If an end station (or its network adapter) supports the IEEE 802.1Q VLAN protocol, it can be configured to broadcast a message to your network indicating the VLAN groups it wants to join. When this switch receives these messages, it will automatically place the receiving port in the specified VLANs, and then forward the message to all other ports. When the message arrives at another switch that supports GVRP, it will also place the receiving port in the specified VLANs, and pass the message on to all other ports. VLAN requirements are propagated in this way throughout the network. This allows GVRP-compliant devices to be automatically configured for VLAN groups based solely on endstation requests.

To implement GVRP in a network, first add the host devices to the required VLANs (using the operating system or other application software), so that these VLANs can be propagated onto the network. For both the edge switches attached directly to these hosts, and core switches in the network, enable GVRP on the links between these devices. You should also determine security boundaries in the network and disable GVRP on the boundary ports to prevent advertisements from being propagated, or forbid those ports from joining restricted VLANs.

**Note:** If you have host devices that do not support GVRP, you should configure static or untagged VLANs for the switch ports connected to these devices (as described in “Adding Static Members to VLANs (VLAN Index)” on page 3-191). But you can still enable GVRP on these edge switches, as well as on the core switches in the network.

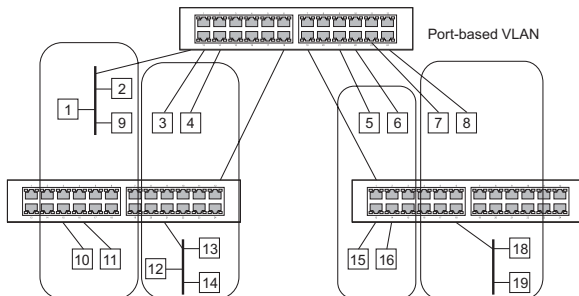

## Forwarding Tagged/Untagged Frames

If you want to create a small port-based VLAN for devices attached directly to a single switch, you can assign ports to the same untagged VLAN. However, to participate in a VLAN group that crosses several switches, you should create a VLAN for that group and enable tagging on all ports.

Ports can be assigned to multiple tagged or untagged VLANs. Each port on the switch is therefore capable of passing tagged or untagged frames. When forwarding a frame from this switch along a path that contains any VLAN-aware devices, the switch should include VLAN tags. When forwarding a frame from this switch along a path that does not contain any VLAN-aware devices (including the destination host), the switch must first strip off the VLAN tag before forwarding the frame. When the switch receives a tagged frame, it will pass this frame onto the VLAN(s) indicated by the frame tag. However, when this switch receives an untagged frame from a VLAN-unaware device, it first decides where to forward the frame, and then inserts a VLAN tag reflecting the ingress port's default VID.

## Enabling or Disabling GVRP (Global Setting)

GARP VLAN Registration Protocol (GVRP) defines a way for switches to exchange VLAN information in order to register VLAN members on ports across the network. VLANs are dynamically configured based on join messages issued by host devices and propagated throughout the network. GVRP must be enabled to permit automatic VLAN registration, and to support VLANs which extend beyond the local switch. (Default: Disabled)

**Web** – Click VLAN, 802.1Q VLAN, GVRP Status. Enable or disable GVRP, click Apply



Figure 3-106 Globally Enabling GVRP

**CLI** – This example enables GVRP for the switch.

```
Console(config)#bridge-ext gvrp
Console(config)#
```

4-248



## Displaying Basic VLAN Information

The VLAN Basic Information page displays basic information on the VLAN type supported by the switch.

### Field Attributes

- **VLAN Version Number**<sup>16</sup> – The VLAN version used by this switch as specified in the IEEE 802.1Q standard.
- **Maximum VLAN ID** – Maximum VLAN ID recognized by this switch.
- **Maximum Number of Supported VLANs** – Maximum number of VLANs that can be configured on this switch.

**Web** – Click VLAN, 802.1Q VLAN, Basic Information.

VLAN Basic Information	
VLAN Version Number	1
Maximum VLAN ID	4094
Maximum Number of Supported VLANs	256

Figure 3-107 Displaying Basic VLAN Information

**CLI** – Enter the following command.

```

Console#show bridge-ext                                     4-249
Max Support VLAN Numbers:                               256
Max Support VLAN ID:                                    4094
Extended Multicast Filtering Services: No
Static Entry Individual Port:                           Yes
VLAN Learning:                                          IVL
Configurable PVID Tagging:                             Yes
Local VLAN Capable:                                    No
Traffic Classes:                                        Enabled
Global GVRP Status:                                    Disabled
GMRP:                                                  Disabled
Console#

```

16. Web Only.

### 3 Configuring the Switch

#### Displaying Current VLANs

The VLAN Current Table shows the current port members of each VLAN and whether or not the port supports VLAN tagging. Ports assigned to a large VLAN group that crosses several switches should use VLAN tagging. However, if you just want to create a small port-based VLAN for one or two switches, you can disable tagging.

##### Command Attributes (Web)

- **VLAN ID** – ID of configured VLAN (1-4094).
- **Up Time at Creation** – Time this VLAN was created (i.e., System Up Time).
- **Status** – Shows how this VLAN was added to the switch.
  - **Dynamic GVRP**: Automatically learned via GVRP.
  - **Permanent**: Added as a static entry.
- **Egress Ports** – Shows all the VLAN port members.
- **Untagged Ports** – Shows the untagged VLAN port members.

**Web** – Click VLAN, 802.1Q VLAN, Current Table. Select any ID from the scroll-down list.

**VLAN Current Table**

VLAN ID: 1

Up Time at Creation	0 d 0 h 0 min 18 s
Status	Permanent

**Egress Ports**

- Unit1 Port1
- Unit1 Port2
- Unit1 Port3
- Unit1 Port4
- Unit1 Port5
- Unit1 Port6
- Unit1 Port7
- Unit1 Port8

**Untagged Ports**

- Unit1 Port1
- Unit1 Port2
- Unit1 Port3
- Unit1 Port4
- Unit1 Port5
- Unit1 Port6
- Unit1 Port7
- Unit1 Port8

Figure 3-108 Displaying Current VLANs

##### Command Attributes (CLI)

- **VLAN** – ID of configured VLAN (1-4094, no leading zeroes).
- **Type** – Shows how this VLAN was added to the switch.
  - **Dynamic**: Automatically learned via GVRP.
  - **Static**: Added as a static entry.

- **Name** – Name of the VLAN (1 to 32 characters).
- **Status** – Shows if this VLAN is enabled or disabled.
  - **Active:** VLAN is operational.
  - **Suspend:** VLAN is suspended; i.e., does not pass packets.
- **Ports / Channel groups** – Shows the VLAN interface members.

**CLI** – Current VLAN information can be displayed with the following command.

```

Console#show vlan id 1                                     4-260
Default VLAN ID : 1

VLAN ID:          1
Type:             Static
Name:             DefaultVlan
Status:           Active
Ports/Port Channels:  Eth1/ 1(S) Eth1/ 2(S) Eth1/ 3(S) Eth1/ 4(S) Eth1/ 5(S)
                    Eth1/ 6(S) Eth1/ 7(S) Eth1/ 8(S) Eth1/ 9(S) Eth1/10(S)
                    Eth1/11(S) Eth1/12(S) Eth1/13(S) Eth1/14(S) Eth1/15(S)
                    Eth1/16(S) Eth1/17(S) Eth1/18(S) Eth1/19(S) Eth1/20(S)
                    Eth1/21(S) Eth1/22(S) Eth1/23(S) Eth1/24(S) Eth1/25(S)
                    Eth1/26(S) Eth1/27(S) Eth1/28(S)

Console#
  
```

## Creating VLANs

Use the VLAN Static List to create or remove VLAN groups. To propagate information about VLAN groups used on this switch to external network devices, you must specify a VLAN ID for each of these groups.

### Command Attributes

- **Current** – Lists all the current VLAN groups created for this system. Up to 256 VLAN groups can be defined. VLAN 1 is the default untagged VLAN. VLAN 4093 is reserved for switch clustering and is not user-configurable or removable.
- **New** – Allows you to specify the name and numeric identifier for a new VLAN group. (The VLAN name is only used for management on this system; it is not added to the VLAN tag.)
- **VLAN ID** – ID of configured VLAN (1-4094, no leading zeroes).
- **VLAN Name** – Name of the VLAN (1 to 32 characters, no spaces).
- **Status (Web)** – Enables or disables the specified VLAN.
  - **Enabled:** VLAN is operational.
  - **Disabled:** VLAN is suspended; i.e., does not pass packets.
- **State (CLI)** – Enables or disables the specified VLAN.
  - **Active:** VLAN is operational.
  - **Suspend:** VLAN is suspended; i.e., does not pass packets.
- **Add** – Adds a new VLAN group to the current list.
- **Remove** – Removes a VLAN group from the current list. If any port is assigned to this group as untagged, it will be reassigned to VLAN group 1 as untagged.

### 3 Configuring the Switch

**Web** – Click VLAN, 802.1Q VLAN, Static List. To create a new VLAN, enter the VLAN ID and VLAN name, mark the Enable checkbox to activate the VLAN, and then click Add.

#### VLAN Static List

---

<b>Current:</b>		<b>New:</b>	
1, DefaultVlan, Enabled	<input type="button" value=" &lt;&lt;Add"/> <input type="button" value=" Remove"/>	VLAN ID (1-4094)	<input type="text"/>
2, RD, Enabled		VLAN Name	<input type="text"/>
4093, ., Enabled		Status	<input type="checkbox"/> Enabled

Figure 3-109 Configuring a VLAN Static List

**CLI** – This example creates a new VLAN.

```
Console(config)#vlan database                               4-252
Console(config-vlan)#vlan 2 name RD media ethernet state active 4-253
Console(config-vlan)#end
Console#show vlan                                         4-260
Default VLAN ID : 1

VLAN ID:          1
Type:             Static
Name:             DefaultVlan
Status:           Active
Ports/Port Channels: Eth1/ 1(S) Eth1/ 2(S) Eth1/ 3(S) Eth1/ 4(S) Eth1/ 5(S)
                   Eth1/ 6(S) Eth1/ 7(S) Eth1/ 8(S) Eth1/ 9(S) Eth1/10(S)
                   Eth1/11(S) Eth1/12(S) Eth1/13(S) Eth1/14(S) Eth1/15(S)
                   Eth1/16(S) Eth1/17(S) Eth1/18(S) Eth1/19(S) Eth1/20(S)
                   Eth1/21(S) Eth1/22(S) Eth1/23(S) Eth1/24(S) Eth1/25(S)
                   Eth1/26(S) Eth1/27(S) Eth1/28(S)

VLAN ID:          2
Type:             Static
Name:             RD
Status:           Active
Ports/Port Channels:

VLAN ID:          4093
Type:             Static
Name:
Status:           Active
Ports/Port Channels: Eth1/ 1(S) Eth1/ 2(S) Eth1/ 3(S) Eth1/ 4(S) Eth1/ 5(S)
                   Eth1/ 6(S) Eth1/ 7(S) Eth1/ 8(S) Eth1/ 9(S) Eth1/10(S)
                   Eth1/11(S) Eth1/12(S) Eth1/13(S) Eth1/14(S) Eth1/15(S)
                   Eth1/16(S) Eth1/17(S) Eth1/18(S) Eth1/19(S) Eth1/20(S)
                   Eth1/21(S) Eth1/22(S) Eth1/23(S) Eth1/24(S) Eth1/25(S)
                   Eth1/26(S) Eth1/27(S) Eth1/28(S)

Console#
```

## Adding Static Members to VLANs (VLAN Index)

Use the VLAN Static Table to configure port members for the selected VLAN index. Assign ports as tagged if they are connected to 802.1Q VLAN compliant devices, or untagged they are not connected to any VLAN-aware devices. Or configure a port as forbidden to prevent the switch from automatically adding it to a VLAN via the GVRP protocol.

- Notes:**
1. You can also use the VLAN Static Membership by Port page to configure VLAN groups based on the port index (page 3-193). However, note that this configuration page can only add ports to a VLAN as tagged members.
  2. VLAN 1 is the default untagged VLAN containing all ports on the switch, and can only be modified by first reassigning the default port VLAN ID as described under "Configuring VLAN Behavior for Interfaces" on page 3-194.

### Command Attributes

- **VLAN** – ID of configured VLAN (1-4094).
- **Name** – Name of the VLAN (1 to 32 characters).
- **Status** – Enables or disables the specified VLAN.
  - **Enable:** VLAN is operational.
  - **Disable:** VLAN is suspended; i.e., does not pass packets.
- **Port** – Port identifier.
- **Membership Type** – Select VLAN membership for each interface by marking the appropriate radio button for a port or trunk:
  - **Tagged:** Interface is a member of the VLAN. All packets transmitted by the port will be tagged, that is, carry a tag and therefore carry VLAN or CoS information.
  - **Untagged:** Interface is a member of the VLAN. All packets transmitted by the port will be untagged, that is, not carry a tag and therefore not carry VLAN or CoS information. Note that an interface must be assigned to at least one group as an untagged port.
  - **Forbidden:** Interface is forbidden from automatically joining the VLAN via GVRP. For more information, see "Automatic VLAN Registration" on page 3-185.
  - **None:** Interface is not a member of the VLAN. Packets associated with this VLAN will not be transmitted by the interface.
- **Trunk Member** – Indicates if a port is a member of a trunk. To add a trunk to the selected VLAN, use the last table on the VLAN Static Table page.

### 3 Configuring the Switch

**Web** – Click VLAN, 802.1Q VLAN, Static Table. Select a VLAN ID from the scroll-down list. Modify the VLAN name and status if required. Select the membership type by marking the appropriate radio button in the list of ports or trunks. Click Apply.

#### VLAN Static Table

VLAN:

Name:

Status:  Enable

Port	Tagged	Untagged	Forbidden	None	Trunk Member
1	<input checked="" type="radio"/>	<input type="radio"/>	<input type="radio"/>	<input type="radio"/>	
2	<input type="radio"/>	<input checked="" type="radio"/>	<input type="radio"/>	<input type="radio"/>	
3	<input type="radio"/>	<input type="radio"/>	<input type="radio"/>	<input checked="" type="radio"/>	
4	<input type="radio"/>	<input type="radio"/>	<input type="radio"/>	<input checked="" type="radio"/>	
5	<input type="radio"/>	<input type="radio"/>	<input type="radio"/>	<input checked="" type="radio"/>	

Figure 3-110 Configuring a VLAN Static Table

**CLI** – The following example adds tagged and untagged ports to VLAN 2.

```
Console(config)#interface ethernet 1/1 4-187  
Console(config-if)#switchport allowed vlan add 2 tagged 4-258  
Console(config-if)#exit  
Console(config)#interface ethernet 1/2  
Console(config-if)#switchport allowed vlan add 2 untagged  
Console(config-if)#exit  
Console(config)#interface ethernet 1/13  
Console(config-if)#switchport allowed vlan add 2 tagged  
Console(config-if)#
```

## Adding Static Members to VLANs (Port Index)

Use the VLAN Static Membership by Port menu to assign VLAN groups to the selected interface as a tagged member.

### Command Attributes

- **Interface** – Port or trunk identifier.
- **Member** – VLANs for which the selected interface is a tagged member.
- **Non-Member** – VLANs for which the selected interface is not a tagged member.

**Web** – Open VLAN, 802.1Q VLAN, Static Membership by Port. Select an interface from the scroll-down box (Port or Trunk). Click Query to display membership information for the interface. Select a VLAN ID, and then click Add to add the interface as a tagged member, or click Remove to remove the interface. After configuring VLAN membership for each interface, click Apply.

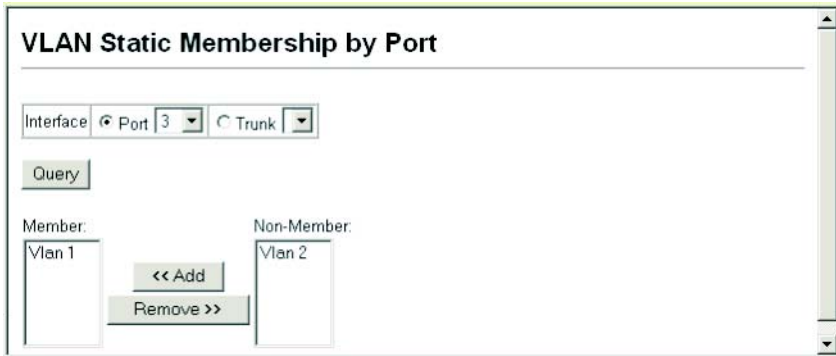

Figure 3-111 VLAN Static Membership by Port

**CLI** – This example adds Port 3 to VLAN 1 as a tagged port, and removes Port 3 from VLAN 2.

```
Console(config)#interface ethernet 1/3          4-187
Console(config-if)#switchport allowed vlan add 1 tagged 4-258
Console(config-if)#switchport allowed vlan remove 2
Console(config-if)#
```

## Configuring VLAN Behavior for Interfaces

You can configure VLAN behavior for specific interfaces, including the default VLAN identifier (PVID), accepted frame types, ingress filtering, GVRP status, and GARP timers.

### Command Usage

- **GVRP** – GARP VLAN Registration Protocol defines a way for switches to exchange VLAN information in order to automatically register VLAN members on interfaces across the network.
- **GARP** – Group Address Registration Protocol is used by GVRP to register or deregister client attributes for client services within a bridged LAN. The default values for the GARP timers are independent of the media access method or data rate. These values should not be changed unless you are experiencing difficulties with GVRP registration/deregistration.

### Command Attributes

- **PVID** – VLAN ID assigned to untagged frames received on the interface. (Default: 1)
  - If an interface is not a member of VLAN 1 and you assign its PVID to this VLAN, the interface will automatically be added to VLAN 1 as an untagged member. For all other VLANs, the PVID must be defined first, then the status of the VLAN can be configured as a tagged or untagged member.
- **Acceptable Frame Type** – Sets the interface to accept all frame types, including tagged or untagged frames, or only tagged frames. When set to receive all frame types, any received frames that are untagged are assigned to the default VLAN. (Options: All, Tagged; Default: All)
- **Ingress Filtering** – Determines how to process frames tagged for VLANs for which the ingress port is not a member. Ingress Filtering is always enabled. (Default: Enabled)
  - Ingress filtering only affects tagged frames.
  - If ingress filtering is disabled and a port receives frames tagged for VLANs for which it is not a member, these frames will be flooded to all other ports (except for those VLANs explicitly forbidden on this port).
  - If ingress filtering is enabled and a port receives frames tagged for VLANs for which it is not a member, these frames will be discarded.
  - Ingress filtering does not affect VLAN independent BPDU frames, such as GVRP or STP. However, they do affect VLAN dependent BPDU frames, such as GMRP.
- **GVRP Status** – Enables/disables GVRP for the interface. GVRP must be globally enabled for the switch before this setting can take effect. (See “Displaying Bridge Extension Capabilities” on page 3-16.) When disabled, any GVRP packets received on this port will be discarded and no GVRP registrations will be propagated from other ports. (Default: Disabled)



- **GARP Join Timer**<sup>17</sup> – The interval between transmitting requests/queries to participate in a VLAN group. (Range: 20-1000 centiseconds; Default: 20)
- **GARP Leave Timer**<sup>17</sup> – The interval a port waits before leaving a VLAN group. This time should be set to more than twice the join time. This ensures that after a Leave or LeaveAll message has been issued, the applicants can rejoin before the port actually leaves the group. (Range: 60-3000 centiseconds; Default: 60)
- **GARP LeaveAll Timer**<sup>17</sup> – The interval between sending out a LeaveAll query message for VLAN group participants and the port leaving the group. This interval should be considerably larger than the Leave Time to minimize the amount of traffic generated by nodes rejoining the group. (Range: 500-18000 centiseconds; Default: 1000)
- **Mode** – Indicates VLAN membership mode for an interface. (Default: Hybrid)
  - **Access** - Sets the port to operate as an untagged interface. All frames are sent untagged.
  - **1Q Trunk** – Specifies a port as an end-point for a VLAN trunk. A trunk is a direct link between two switches, so the port transmits tagged frames that identify the source VLAN. Note that frames belonging to the port's default VLAN (i.e., associated with the PVID) are also transmitted as tagged frames.
  - **Hybrid** – Specifies a hybrid VLAN interface. The port may transmit tagged or untagged frames.
- **Trunk Member** – Indicates if a port is a member of a trunk. To add a trunk to the selected VLAN, use the last table on the VLAN Static Table page.

---

17. Timer settings must follow this rule: 2 x (join timer) < leave timer < leaveAll timer

**Web** – Click VLAN, 802.1Q VLAN, Port Configuration or Trunk Configuration. Fill in the required settings for each interface, click Apply.

Port	PVID	Acceptable Frame Type	Ingress Filtering	Mode	Trunk Member
1	1	ALL	<input checked="" type="checkbox"/> Enabled	Hybrid	
2	1	ALL	<input checked="" type="checkbox"/> Enabled	Hybrid	
3	1	ALL	<input checked="" type="checkbox"/> Enabled	Hybrid	
4	1	ALL	<input checked="" type="checkbox"/> Enabled	Hybrid	
5	1	ALL	<input checked="" type="checkbox"/> Enabled	Hybrid	
6	1	ALL	<input checked="" type="checkbox"/> Enabled	Hybrid	
7	1	ALL	<input checked="" type="checkbox"/> Enabled	Hybrid	
8	1	ALL	<input checked="" type="checkbox"/> Enabled	Hybrid	

Figure 3-112 Configuring VLANs per Port

**CLI** – This example sets port 3 to accept only tagged frames, assigns PVID 3 as the native VLAN ID, enables GVRP, sets the GARP timers, and then sets the switchport mode to hybrid.

```

Console(config)#interface ethernet 1/3                               4-187
Console(config-if)#switchport acceptable-frame-types tagged        4-255
Console(config-if)#switchport ingress-filtering                    4-256
Console(config-if)#switchport native vlan 3                        4-257
Console(config-if)#switchport gvrp                                4-249
Console(config-if)#garp timer join 20                              4-250
Console(config-if)#garp timer leave 90
Console(config-if)#garp timer leaveall 2000
Console(config-if)#switchport mode hybrid                          4-255
Console(config-if)#

```

## Configuring IEEE 802.1Q Tunneling

IEEE 802.1Q Tunneling (QinQ) is designed for service providers carrying traffic for multiple customers across their networks. QinQ tunneling is used to maintain customer-specific VLAN and Layer 2 protocol configurations even when different customers use the same internal VLAN IDs. This is accomplished by inserting Service Provider VLAN (SPVLAN) tags into the customer's frames when they enter the service provider's network, and then stripping the tags when the frames leave the network.

A service provider's customers may have specific requirements for their internal VLAN IDs and number of VLANs supported. VLAN ranges required by different customers in the same service-provider network might easily overlap, and traffic passing through the infrastructure might be mixed. Assigning a unique range of VLAN IDs to each customer would restrict customer configurations, require intensive

processing of VLAN mapping tables, and could easily exceed the maximum VLAN limit of 4096.

QinQ tunneling uses a single Service Provider VLAN (SPVLAN) for customers who have multiple VLANs. Customer VLAN IDs are preserved and traffic from different customers is segregated within the service provider's network even when they use the same customer-specific VLAN IDs. QinQ tunneling expands VLAN space by using a VLAN-in-VLAN hierarchy, preserving the customer's original tagged packets, and adding SPVLAN tags to each frame (also called double tagging).

A port configured to support QinQ tunneling must be set to tunnel port mode. The Service Provider VLAN (SPVLAN) ID for the specific customer must be assigned to the QinQ tunnel access port on the edge switch where the customer traffic enters the service provider's network. Each customer requires a separate SPVLAN, but this VLAN supports all of the customer's internal VLANs. The QinQ tunnel uplink port that passes traffic from the edge switch into the service provider's metro network must also be added to this SPVLAN. The uplink port can be added to multiple SPVLANs to carry inbound traffic for different customers onto the service provider's network.

When a double-tagged packet enters another trunk port in an intermediate or core switch in the service provider's network, the outer tag is stripped for packet processing. When the packet exits another trunk port on the same core switch, the same SPVLAN tag is again added to the packet.

When a packet enters the trunk port on the service provider's egress switch, the outer tag is again stripped for packet processing. However, the SPVLAN tag is not added when it is sent out the tunnel access port on the edge switch into the customer's network. The packet is sent as a normal IEEE 802.1Q-tagged frame, preserving the original VLAN numbers used in the customer's network.

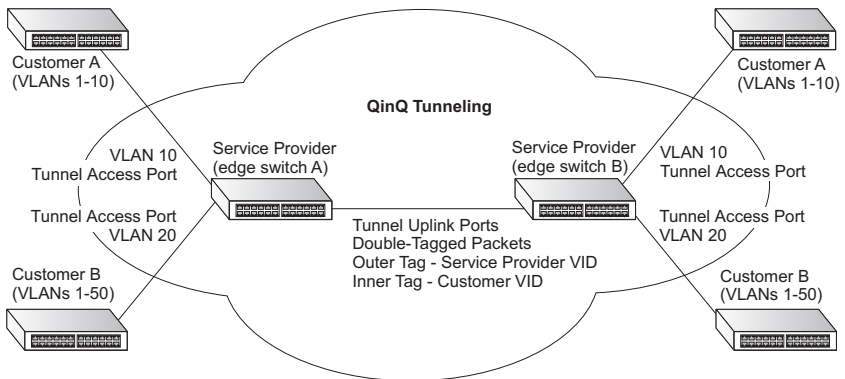

### Layer 2 Flow for Packets Coming into a Tunnel Access Port

A QinQ tunnel port may receive either tagged or untagged packets. No matter how many tags the incoming packet has, it is treated as tagged packet.

### 3 Configuring the Switch

The ingress process does source and destination lookups. If both lookups are successful, the ingress process writes the packet to memory. Then the egress process transmits the packet. Packets entering a QinQ tunnel port are processed in the following manner:

1. New SPVLAN tags are added to all incoming packets, no matter how many tags they already have. The ingress process constructs and inserts the outer tag (SPVLAN) into the packet based on the default VLAN ID and Tag Protocol Identifier (TPID, that is, the ether-type of the tag). This outer tag is used for learning and switching packets. The priority of the inner tag is copied to the outer tag if it is a tagged or priority tagged packet.
2. After successful source and destination lookup, the ingress process sends the packet to the switching process with two tags. If the incoming packet is untagged, the outer tag is an SPVLAN tag, and the inner tag is a dummy tag (8100 0000). If the incoming packet is tagged, the outer tag is an SPVLAN tag, and the inner tag is a CVLAN tag.
3. After packet classification through the switching process, the packet is written to memory with one tag (an outer tag) or with two tags (both an outer tag and inner tag).
4. The switch sends the packet to the proper egress port.
5. If the egress port is an untagged member of the SPVLAN, the outer tag will be stripped. If it is a tagged member, the outgoing packets will have two tags.

#### *Layer 2 Flow for Packets Coming into a Tunnel Uplink Port*

An uplink port receives one of the following packets:

- Untagged
- One tag (CVLAN or SPVLAN)
- Double tag (CVLAN + SPVLAN)

The ingress process does source and destination lookups. If both lookups are successful, the ingress process writes the packet to memory. Then the egress process transmits the packet. Packets entering a QinQ uplink port are processed in the following manner:

1. If incoming packets are untagged, the PVID VLAN native tag is added.
2. If the ether-type of an incoming packet (single or double tagged) is not equal to the TPID of the uplink port, the VLAN tag is determined to be a Customer VLAN (CVLAN) tag. The uplink port's PVID VLAN native tag is added to the packet. This outer tag is used for learning and switching packets within the service provider's network. The TPID must be configured on a per port basis, and the verification cannot be disabled.
3. If the ether-type of an incoming packet (single or double tagged) is equal to the TPID of the uplink port, no new VLAN tag is added. If the uplink port is not the member of the outer VLAN of the incoming packets, the packet will be dropped when ingress filtering is enabled. If ingress filtering is not enabled, the packet will

still be forwarded. If the VLAN is not listed in the VLAN table, the packet will be dropped.

4. After successful source and destination lookups, the packet is double tagged. The switch uses the TPID of 0x8100 to indicate that an incoming packet is double-tagged. If the outer tag of an incoming double-tagged packet is equal to the port TPID and the inner tag is 0x8100, it is treated as a double-tagged packet. If a single-tagged packet has 0x8100 as its TPID, and port TPID is not 0x8100, a new VLAN tag is added and it is also treated as double-tagged packet.
5. If the destination address lookup fails, the packet is sent to all member ports of the outer tag's VLAN.
6. After packet classification, the packet is written to memory for processing as a single-tagged or double-tagged packet.
7. The switch sends the packet to the proper egress port.
8. If the egress port is an untagged member of the SPVLAN, the outer tag will be stripped. If it is a tagged member, the outgoing packet will have two tags.

#### *Configuration Limitations for QinQ*

- The native VLAN of uplink ports should not be used as the SPVLAN. If the SPVLAN is the uplink port's native VLAN, the uplink port must be an untagged member of the SPVLAN. Then the outer SPVLAN tag will be stripped when the packets are sent out. Another reason is that it causes non-customer packets to be forwarded to the SPVLAN.
- Static trunk port groups are compatible with QinQ tunnel ports as long as the QinQ configuration is consistent within a trunk port group.
- The native VLAN (VLAN 1) is not normally added to transmitted frames. Avoid using VLAN 1 as an SPVLAN tag for customer traffic to reduce the risk of misconfiguration. Instead, use VLAN 1 as a management VLAN instead of a data VLAN in the service provider network.
- There are some inherent incompatibilities between Layer 2 and Layer 3 switching:
  - Tunnel ports do not support IP Access Control Lists.
  - Layer 3 Quality of Service (QoS) and other QoS features containing Layer 3 information are not supported on tunnel ports.
  - Spanning tree bridge protocol data unit (BPDU) filtering is automatically disabled on a tunnel port.

#### *General Configuration Guidelines for QinQ*

1. Configure the switch to QinQ mode (see "Enabling QinQ Tunneling on the Switch" on page 3-200).
2. Set the Tag Protocol Identifier (TPID) value of the tunnel access port. This step is required if the attached client is using a nonstandard 2-byte ethertype to identify 802.1Q tagged frames. The default ethertype value is 0x8100. (See "Adding an Interface to a QinQ Tunnel" on page 3-201.)

### 3 Configuring the Switch

3. Create a Service Provider VLAN, also referred to as an SPVLAN (see “Creating VLANs” on page 3-189).
4. Configure the QinQ tunnel access port to 802.1Q Tunnel mode (see “Adding an Interface to a QinQ Tunnel” on page 3-201).
5. Configure the QinQ tunnel access port to join the SPVLAN as an untagged member (see “Adding Static Members to VLANs (VLAN Index)” on page 3-191).
6. Configure the SPVLAN ID as the native VID on the QinQ tunnel access port (see “Configuring VLAN Behavior for Interfaces” on page 3-194).
7. Configure the QinQ tunnel uplink port to 802.1Q Tunnel Uplink mode (see “Adding an Interface to a QinQ Tunnel” on page 3-201).
8. Configure the QinQ tunnel uplink port to join the SPVLAN as a tagged member (see “Adding Static Members to VLANs (VLAN Index)” on page 3-191).

#### Enabling QinQ Tunneling on the Switch

The switch can be configured to operate in normal VLAN mode or IEEE 802.1Q (QinQ) tunneling mode which is used for passing Layer 2 traffic across a service provider’s metropolitan area network. You can also globally set the Tag Protocol Identifier (TPID) value of the tunnel port if the attached client is using a nonstandard 2-byte ethertype to identify 802.1Q tagged frames.

#### Command Usage

- Use the TPID field to set a custom 802.1Q ethertype value on the selected interface. This feature allows the switch to interoperate with third-party switches that do not use the standard 0x8100 ethertype to identify 802.1Q-tagged frames. For example, if 0x1234 is set as the custom 802.1Q ethertype on a trunk port, incoming frames containing that ethertype are assigned to the VLAN contained in the tag following the ethertype field, as they would be with a standard 802.1Q trunk. Frames arriving on the port containing any other ethertype are looked upon as untagged frames, and assigned to the native VLAN of that port.
- All ports on the switch will be set to the same ethertype.

#### Command Attributes

- **802.1Q Tunnel Status** – Sets the switch to QinQ mode, and allows the QinQ tunnel port to be configured. The default is for the switch to function in normal mode.
- **802.1Q Ethernet Type** – The Tag Protocol Identifier (TPID) specifies the ethertype of incoming packets on a tunnel port. (Range: hexadecimal 0800-FFFF; Default: 8100)

**Web** – Click VLAN, 802.1Q VLAN, 802.1Q Tunnel Configuration. Check the Enabled box, set the TPID of the ports if the client is using a non-standard ethertype to identify 802.1Q tagged frames, and click Apply.

802.1Q Tunnel Configuration	
802.1Q Tunnel Status	<input checked="" type="checkbox"/> Enabled
802.1Q Ethernet Type	9100 (0800-FFFF, hexadecimal value)

Figure 3-113 802.1Q Tunnel Status and Ethernet Type

**CLI** – This example sets the switch to operate in QinQ mode.

```

Console(config)#dot1q-tunnel system-tunnel-control          4-262
Console(config-if)#switchport dot1q-tunnel tpid 9100      4-263
Console(config)#exit
Console#show dot1q-tunnel                                  4-264

Current double-tagged status of the system is Enabled

The dot1q-tunnel mode of the set interface 1/1 is Access mode, TPID is 0x9100.
The dot1q-tunnel mode of the set interface 1/2 is Uplink mode, TPID is 0x9100.
The dot1q-tunnel mode of the set interface 1/3 is Normal mode, TPID is 0x9100.
The dot1q-tunnel mode of the set interface 1/4 is Normal mode, TPID is 0x9100.
The dot1q-tunnel mode of the set interface 1/5 is Normal mode, TPID is 0x9100.
.
.
.

```

### Adding an Interface to a QinQ Tunnel

Follow the guidelines in the preceding section to set up a QinQ tunnel on the switch. Use the VLAN Port Configuration or VLAN Trunk Configuration screen to set the access port on the edge switch to 802.1Q Tunnel mode.

#### Command Usage

- Use the 802.1Q Tunnel Status screen to set the switch to QinQ mode before configuring a tunnel port (see “Enabling QinQ Tunneling on the Switch” on page 3-200). Also set the Tag Protocol Identifier (TPID) value of the tunnel port if the attached client is using a nonstandard 2-byte ethertype to identify 802.1Q tagged frames (see “Enabling QinQ Tunneling on the Switch” on page 3-200).
- Set the mode to 802.1Q Tunnel (access) or 802.1Q Tunnel Uplink.

#### Command Attributes

**Mode** – Set the VLAN membership mode of the port.

- **None** – The port operates in its normal VLAN mode. (This is the default.)
- **802.1Q Tunnel** – Configures IEEE 802.1Q tunneling (QinQ) for a client access port to segregate and preserve customer VLAN IDs for traffic crossing the service provider network.
- **802.1Q Tunnel Uplink** – Configures IEEE 802.1Q tunneling (QinQ) for an uplink port to another device within the service provider network.
- **Trunk Member** – Shows if a port is a member or a trunk.

### 3 Configuring the Switch

**Web** – Click VLAN, 802.1Q VLAN, 802.1Q Tunnel Configuration or Tunnel Trunk Configuration. Set the mode for a tunnel access port to 802.1Q Tunnel and a tunnel uplink port to 802.1Q Tunnel Uplink. Click Apply.

802.1Q Tunnel Port Configuration		
Port	Mode	Trunk Member
1	None	
2	802.1Q Tunnel	
3	802.1Q Tunnel Uplink	
4	None	
5	None	

Figure 3-114 Tunnel Port Configuration

**CLI** – This example sets port 2 to tunnel access mode, and sets port 3 to tunnel uplink mode.

```
Console(config)#interface ethernet 1/2 4-187
Console(config-if)#switchport dot1q-tunnel mode access 4-262
Console(config-if)#interface ethernet 1/3
Console(config-if)#switchport dot1q-tunnel mode uplink 4-262
Console(config-if)#end
Console#show dot1q-tunnel 4-264

Current double-tagged status of the system is Enabled
The dot1q-tunnel mode of the set interface 1/1 is Normal mode, TPID is 0x9100.
The dot1q-tunnel mode of the set interface 1/2 is Access mode, TPID is 0x9100.
The dot1q-tunnel mode of the set interface 1/3 is Uplink mode, TPID is 0x9100.
The dot1q-tunnel mode of the set interface 1/4 is Normal mode, TPID is 0x9100.
The dot1q-tunnel mode of the set interface 1/5 is Normal mode, TPID is 0x9100.
The dot1q-tunnel mode of the set interface 1/6 is Normal mode, TPID is 0x9100.
The dot1q-tunnel mode of the set interface 1/7 is Normal mode, TPID is 0x9100.
:
```

## Traffic Segmentation

If tighter security is required for passing traffic from different clients through downlink ports on the local network and over uplink ports to the service provider, port-based traffic segmentation can be used to isolate traffic for individual client sessions.

Traffic belonging to each client is isolated to the allocated downlink ports. But the switch can be configured to either isolate traffic passing across a client's allocated uplink ports from the uplink ports assigned to other clients, or to forward traffic through the uplink ports used by other clients, allowing different clients to share access to their uplink ports where security is less likely to be compromised.

### Configuring Global Settings for Traffic Segmentation

Use the Traffic Segmentation Status page to enable traffic segmentation, and to block or forward traffic between uplink ports assigned to different client sessions.



### Command Attributes

- **Traffic Segmentation Status** – Enables port-based traffic segmentation. (Default: Disabled)
- **Uplink-to-Uplink** – Specifies whether or not traffic can be forwarded between uplink ports assigned to different client sessions. (Default: Blocking)

**Web** – Click VLAN, Traffic Segmentation, Status. Set the traffic segmentation status or uplink-to-uplink forwarding mode, and click Apply.

### Traffic Segmentation Status

---

Traffic Segmentation Status	<input type="checkbox"/> Enabled
Uplink-to-Uplink	Blocking ▼

Figure 3-115 Traffic Segmentation Status Configuration

**CLI** – This example enables traffic segmentation and allows traffic to be forwarded across the uplink ports assigned to different client sessions.

```

Console(config)#pvlan                               4-265
Console(config)#pvlan up-to-up forwarding           4-268
Console(config)#exit
Console#show pvlan                                  4-268

Private VLAN Status :                               Enabled
Uplink-to-Uplink Mode :                             Forwarding

Session  Uplink Ports                               Downlink Ports
-----
1
Console#
  
```

### Configuring Traffic Segmentation Sessions

Use the Traffic Segmentation Session Configuration page to create a client session, and assign the downlink and uplink ports to service the traffic associated with each session.

#### Command Attributes

- **Session ID** – Traffic segmentation session. (Range: 1-15)
- **Direction** – Uplink or downlink interface.
- **Interface** – Port or trunk used for assigned traffic segmentation session. Due to switch ASIC limitations, ports 1-8, 9-16, 17-24 are grouped together when any of the group members are configured as an uplink or downlink interface.

### 3 Configuring the Switch

**Web** – Click VLAN, Traffic Segmentation, Status. Set the traffic segmentation status or uplink-to-uplink forwarding mode, and click Apply.

**Traffic Segmentation Session Configuration**

Session List:  
Current:

Session 1, uplink, Unit1 Port28
---------------------------------

<<Add Remove

New:

Session ID (1-15)

Direction Uplink

Interface  Port  Trunk

Port 1

Figure 3-116 Traffic Segmentation Session Configuration

**CLI** – This example enables traffic segmentation and allows traffic to be forwarded across the uplink ports assigned to different client sessions.

```
Console(config)#pvlan session 1 uplink ethernet 1/28 downlink ethernet 1/14-266
Console(config)#exit
Console#show pvlan 4-268

Private VLAN Status : Enabled
Uplink-to-Uplink Mode : Forwarding

Session Uplink Ports Downlink Ports
-----
1 Ethernet 1/28 Ethernet 1/1
Ethernet 1/2
Ethernet 1/3
Ethernet 1/4
Ethernet 1/5
Ethernet 1/6
Ethernet 1/7
Ethernet 1/8

Console#
```

## Private VLANs

Private VLANs provide port-based security and isolation between ports within the assigned VLAN. This switch supports private VLANs with primary/secondary associated groups. A primary VLAN contains promiscuous ports that can communicate with all other ports in the private VLAN group, while a secondary (or community) VLAN contains community ports that can only communicate with other hosts within the secondary VLAN and with any of the promiscuous ports in the associated primary VLAN. In all cases, the promiscuous ports are designed to provide open access to an external network such as the Internet, while the community ports provide restricted access to local users.

Multiple primary VLANs can be configured on this switch, and multiple community VLANs can be associated with each primary VLAN. (Note that private VLANs and normal VLANs can exist simultaneously within the same switch.)

To configure primary/secondary associated groups, follow these steps:

1. Use the Private VLAN Configuration menu (page 3-206) to designate one or more community VLANs, and the primary VLAN that will channel traffic outside of the VLAN groups.
2. Use the Private VLAN Association menu (page 3-207) to map the secondary (i.e., community) VLAN(s) to the primary VLAN.
3. Use the Private VLAN Port Configuration menu (page 3-208) to set the port type to promiscuous (i.e., having access to all ports in the primary VLAN), or host (i.e., having access restricted to community VLAN members, and channeling all other traffic through promiscuous ports). Then assign any promiscuous ports to a primary VLAN and any host ports a community VLAN.

### Displaying Current Private VLANs

The Private VLAN Information page displays information on the private VLANs configured on the switch, including primary, community, and isolated VLANs, and their assigned interfaces.

#### Command Attributes

- **VLAN ID** – ID of configured VLAN (1-4092), and VLAN type.
- **Primary VLAN** – The VLAN with which the selected VLAN ID is associated. A primary VLAN displays its own ID, a community VLAN displays the associated primary VLAN, and an isolated VLAN displays the stand-alone VLAN.
- **Ports List** – The list of ports (and assigned port type) in the selected private VLAN.

**Web** – Click VLAN, Private VLAN, Information. Select the desired port from the VLAN ID drop-down menu.

### Private VLAN Information

---

VLAN ID: 5, Primary VLAN

Primary VLAN\VLAN 5

---

**Ports List**

Unit 1, Port 3, Promiscuous
Unit 1, Port 4, Host
Unit 1, Port 5, Host

Figure 3-117 Private VLAN Information

### 3 Configuring the Switch

**CLI** – This example shows the switch configured with primary VLAN 5 and secondary VLAN 6. Port 3 has been configured as a promiscuous port and mapped to VLAN 5, while ports 4 and 5 have been configured as a host ports and are associated with VLAN 6. This means that traffic for port 4 and 5 can only pass through port 3.

```
Console#show vlan private-vlan 4-260
Primary   Secondary   Type           Interfaces
-----
          5           primary        Eth1/ 3
          5           6             community      Eth1/ 4 Eth1/ 5
Console#
```

#### Configuring Private VLANs

The Private VLAN Configuration page is used to create/remove primary or community VLANs.

#### Command Attributes

- **VLAN ID** – ID of configured VLAN (2-4094).
- **Type** – There are two types of private VLANs:
  - **Primary VLANs** – Conveys traffic between promiscuous ports, and to community ports within secondary (or community) VLANs.
  - **Community VLANs** - Conveys traffic between community ports, and to their promiscuous ports in the associated primary VLAN.
- **Current** – Displays a list of the currently configured VLANs.

**Web** – Click VLAN, Private VLAN, Configuration. Enter the VLAN ID number, select Primary or Community type, then click Add. To remove a private VLAN from the switch, highlight an entry in the Current list box and then click Remove. Note that all member ports must be removed from the VLAN before it can be deleted.

**Private VLAN Configuration**

**Current:**

- 5, Primary VLAN
- 6, Community VLAN
- 7, Community VLAN

**New:**

VLAN ID (1-4094)

Type

<<Add Remove

Figure 3-118 Private VLAN Configuration

**CLI** – This example configures VLAN 5 as a primary VLAN, and VLAN 6 as a community VLAN.

```
Console(config)#vlan database 4-252
Console(config-vlan)#private-vlan 5 primary 4-270
Console(config-vlan)#private-vlan 6 community
Console(config-vlan)#
```

## Associating VLANs

Each community VLAN must be associated with a primary VLAN.

### Command Attributes

- **Primary VLAN ID** – ID of primary VLAN (2-4094).
- **Association** – Community VLANs associated with the selected primary VLAN.
- **Non-Association** – Community VLANs not associated with the selected VLAN.

**Web** – Click VLAN, Private VLAN, Association. Select the required primary VLAN from the scroll-down box, highlight one or more community VLANs in the Non-Association list box, and click Add to associate these entries with the selected primary VLAN. (A community VLAN can only be associated with one primary VLAN.)



Figure 3-119 Private VLAN Association

**CLI** – This example associates community VLANs 6 and 7 with primary VLAN 5.

```

Console(config)#vlan database                               4-252
Console(config-vlan)#private-vlan 5 association 6          4-271
Console(config-vlan)#private-vlan 5 association 7          4-271
Console(config)#
  
```

## Displaying Private VLAN Interface Information

Use the Private VLAN Port Information and Private VLAN Trunk Information menus to display the interfaces associated with private VLANs.

### Command Attributes

- **Port/Trunk** – The switch interface.
- **PVLAN Port Type** – Displays private VLAN port types.
  - **Normal** – The port is not configured in a private VLAN.
  - **Host** – The port is a community port and can only communicate with other ports in its own community VLAN, and with the designated promiscuous port(s). Or the port is an isolated port that can only communicate with the lone promiscuous port within its own isolated VLAN.
  - **Promiscuous** – A promiscuous port can communicate with all the interfaces within a private VLAN.

### 3 Configuring the Switch

- **Primary VLAN** – Conveys traffic between promiscuous ports, and between promiscuous ports and community ports within the associated secondary VLANs.
- **Community VLAN** – A community VLAN conveys traffic between community ports, and from community ports to their designated promiscuous ports.
- **Trunk** – The trunk identifier. (Port Information only)

**Web** – Click VLAN, Private VLAN, Port Information or Trunk Information.

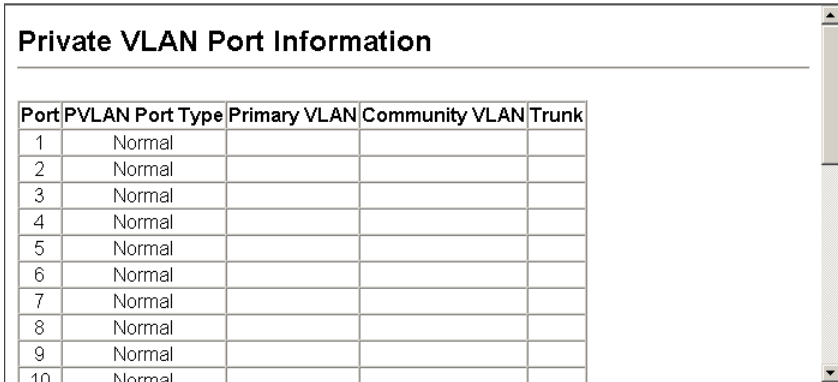

The screenshot shows a web interface window titled "Private VLAN Port Information". It contains a table with the following columns: Port, PVLAN Port Type, Primary VLAN, Community VLAN, and Trunk. The table lists 10 ports, all with a "Normal" PVLAN Port Type. The Primary and Community VLAN columns are empty, and the Trunk column is also empty.

Port	PVLAN Port Type	Primary VLAN	Community VLAN	Trunk
1	Normal			
2	Normal			
3	Normal			
4	Normal			
5	Normal			
6	Normal			
7	Normal			
8	Normal			
9	Normal			
10	Normal			

Figure 3-120 Private VLAN Port Information

**CLI** – This example shows the switch configured with primary VLAN 5 and community VLAN 6. Port 3 has been configured as a promiscuous port and mapped to VLAN 5, while ports 4 and 5 have been configured as host ports and associated with VLAN 6. This means that traffic for port 4 and 5 can only pass through port 3.

```
Console#show vlan private-vlan 4-273
Primary   Secondary   Type         Interfaces
-----
          5           primary     Eth1/ 3
          5           community   Eth1/ 4 Eth1/ 5
Console#
```

### Configuring Private VLAN Interfaces

Use the Private VLAN Port Configuration and Private VLAN Trunk Configuration menus to set the private VLAN interface type, and assign the interfaces to a private VLAN.

#### Command Attributes

- **Port/Trunk** – The switch interface.
- **PVLAN Port Type** – Sets the private VLAN port types.
  - **Normal** – The port is not assigned to a private VLAN.
  - **Host** – The port is a community port. A community port can communicate with other ports in its own community VLAN and with designated promiscuous port(s).

- **Promiscuous** – A promiscuous port can communicate with all interfaces within a private VLAN.
- **Primary VLAN** – Conveys traffic between promiscuous ports, and between promiscuous ports and community ports within the associated secondary VLANs. If PVLAN type is “Promiscuous,” then specify the associated primary VLAN.
- **Community VLAN** – A community VLAN conveys traffic between community ports, and from community ports to their designated promiscuous ports. Set PVLAN Port Type to “Host,” and then specify the associated Community VLAN.
- **Trunk** – The trunk identifier. (Port Information only)

**Web** – Click VLAN, Private VLAN, Port Configuration or Trunk Configuration. Set the PVLAN Port Type for each port that will join a private VLAN. Assign promiscuous ports to a primary VLAN. Assign host ports to a community VLAN. After all the ports have been configured, click Apply.

### Private VLAN Port Configuration

Port	PVLAN Port Type	Primary VLAN	Community VLAN	Trunk
1	Normal	(none)	(none)	
2	Normal	(none)	(none)	
3	Normal	(none)	(none)	
4	Normal	(none)	(none)	
5	Normal	(none)	(none)	
6	Normal	(none)	(none)	
7	Normal	(none)	(none)	
8	Normal	(none)	(none)	

Figure 3-121 Private VLAN Port Configuration

**CLI** – This example shows the switch configured with primary VLAN 5 and secondary VLAN 6. Port 3 has been configured as a promiscuous port and mapped to VLAN 5, while ports 4 and 5 have been configured as a host ports and associated with VLAN 6. This means that traffic for port 4 and 5 can only pass through port 3.

```

Console(config)#interface ethernet 1/3
Console(config-if)#switchport mode private-vlan promiscuous           4-271
Console(config-if)#switchport private-vlan mapping 5                  4-273
Console(config-if)#exit
Console(config)#interface ethernet 1/4
Console(config-if)#switchport mode private-vlan host                  4-271
Console(config-if)#switchport private-vlan host-association 6        4-272
Console(config-if)#exit
Console(config)#interface ethernet 1/5
Console(config-if)#switchport mode private-vlan host
Console(config-if)#switchport private-vlan host-association 6
Console(config-if)#

```

### Protocol VLANs

The network devices required to support multiple protocols cannot be easily grouped into a common VLAN. This may require non-standard devices to pass traffic between different VLANs in order to encompass all the devices participating in a specific protocol. This kind of configuration deprives users of the basic benefits of VLANs, including security and easy accessibility.

To avoid these problems, you can configure this switch with protocol-based VLANs that divide the physical network into logical VLAN groups for each required protocol. When a frame is received at a port, its VLAN membership can then be determined based on the protocol type being used by the inbound packets.

#### Command Usage

To configure protocol-based VLANs, follow these steps:

1. First configure VLAN groups for the protocols you want to use (page 3-189). Although not mandatory, we suggest configuring a separate VLAN for each major protocol running on your network. Do not add port members at this time.
2. Create a protocol group for each of the protocols you want to assign to a VLAN using the Protocol VLAN Configuration page.
3. Then map the protocol for each interface to the appropriate VLAN using the Protocol VLAN Port Configuration page.

### Configuring Protocol VLAN Groups

Use the Protocol VLAN Configuration menu to create or remove protocol groups.

#### Command Attributes

- **Protocol Group ID** – Protocol Group ID assigned to the Protocol VLAN Group. (Range: 1-2147483647)
- **Frame Type** – Choose either Ethernet, RFC 1042, or LLC Other as the frame type used by this protocol.
- **Protocol Type** – Specifies the protocol type to match. The available options are IP, ARP, and RARP. If LLC Other is chosen for the Frame Type, the only available Protocol Type is IPX Raw

**Note:** Traffic which matches IP Protocol Ethernet Frames is mapped to the VLAN (VLAN 1) that has been configured with the switch's administrative IP. IP Protocol Ethernet traffic must not be mapped to another VLAN or you will lose administrative network connectivity to the switch. If lost in this manner, network access can be regained by removing the offending Protocol VLAN rule via the console. Alternately, the switch can be power-cycled, however all unsaved configuration changes will be lost.



**Web** – Click VLAN, Protocol VLAN, Configuration.

### Protocol VLAN Configuration

---

<b>Current:</b>		<b>New:</b>	
(none)	<input type="button" value=" &lt;&lt;Add"/> <input type="button" value=" Remove"/>	Protocol Group ID (1-2147483647)	
		Frame Type	Ethernet ▾
		Protocol Type	IP ▾

**Figure 3-122 Protocol VLAN Configuration**

**CLI** – This example shows the switch configured with Protocol Group 2 which matches RFC 1042 IP traffic.

```

Console(config)#protocol-vlan protocol group 2 add frame-type
  rfc-1042 protocol-type ip
Console(config)#
```

4-275

## Configuring the Protocol VLAN System

Use the Protocol VLAN System Configuration menu to map a Protocol VLAN Group to a VLAN.

### Command Usage

When a frame enters a port that has been assigned to a protocol VLAN, it is processed in the following manner:

- If the frame is tagged, it will be processed according to the standard rules applied to tagged frames.
- If the frame is untagged and the protocol type matches, the frame is forwarded to the appropriate VLAN.
- If the frame is untagged but the protocol type does not match, the frame is forwarded to the default VLAN for this interface.

### Command Attributes

- **Protocol Group ID** – Protocol Group ID assigned to the Protocol VLAN Group. (Range: 1-2147483647)
- **VLAN ID** – VLAN to which matching protocol traffic is forwarded. (Range: 1-4094)

### 3 Configuring the Switch

**Web** – Click VLAN, Protocol VLAN, System Configuration.

Current:	New:
Group 2, VLAN 2	Protocol Group ID (1-2147483647)
<<Add	<input type="text"/>
Remove	VLAN ID (1-4092)
	<input type="text"/>

Figure 3-123 Protocol VLAN System Configuration

**CLI** – This example shows the switch configured with Protocol Group 2 mapped to VLAN 2.

```
Console(config)#protocol-vlan protocol-group 2 vlan 2  
Console(config)#
```

4-275

## Link Layer Discovery Protocol

Link Layer Discovery Protocol (LLDP) is used to discover basic information about neighboring devices on the local broadcast domain. LLDP is a Layer 2 protocol that uses periodic broadcasts to advertise information about the sending device.

Advertised information is represented in Type Length Value (TLV) format according to the IEEE 802.1ab standard, and can include details such as device identification, capabilities and configuration settings. LLDP also defines how to store and maintain information gathered about the neighboring network nodes it discovers.

Link Layer Discovery Protocol - Media Endpoint Discovery (LLDP-MED) is an extension of LLDP intended for managing endpoint devices such as Voice over IP phones and network switches. The LLDP-MED TLVs advertise information such as network policy, power, inventory, and device location details. LLDP and LLDP-MED information can be used by SNMP applications to simplify troubleshooting, enhance network management, and maintain an accurate network topology.

## Setting LLDP Timing Attributes

Use the LLDP Configuration screen to set attributes for general functions such as globally enabling LLDP on the switch, setting the message ageout time, and setting the frequency for broadcasting general advertisements or reports about changes in the LLDP MIB.

### Command Attributes

- **LLDP** – Enables LLDP globally on the switch. (Default: Enabled)
- **Transmission Interval** – Configures the periodic transmit interval for LLDP advertisements. (Range: 5-32768 seconds; Default: 30 seconds)  
This attribute must comply with the following rule:  
(Transmission Interval \* Hold Time Multiplier)  $\leq$  65536, and  
Transmission Interval  $\geq$  (4 \* Delay Interval)
- **Hold Time Multiplier** – Configures the time-to-live (TTL) value sent in LLDP advertisements as shown in the formula below. (Range: 2-10; Default: 4)  
The time-to-live tells the receiving LLDP agent how long to retain all information pertaining to the sending LLDP agent if it does not transmit updates in a timely manner.  
TTL in seconds is based on the following rule:  
(Transmission Interval \* Holdtime Multiplier)  $\leq$  65536.  
Therefore, the default TTL is 4\*30 = 120 seconds.
- **Delay Interval** – Configures a delay between the successive transmission of advertisements initiated by a change in local LLDP MIB variables. (Range: 1-8192 seconds; Default: 2 seconds)  
The transmit delay is used to prevent a series of successive LLDP transmissions during a short period of rapid changes in local LLDP MIB objects, and to increase the probability that multiple, rather than single changes, are reported in each transmission.  
This attribute must comply with the rule: (4 \* Delay Interval)  $\leq$  Transmission Interval
- **Reinitialization Delay** – Configures the delay before attempting to re-initialize after LLDP ports are disabled or the link goes down. (Range: 1-10 seconds; Default: 2 seconds)  
When LLDP is re-initialized on a port, all information in the remote systems LLDP MIB associated with this port is deleted.
- **Notification Interval** – Configures the allowed interval for sending SNMP notifications about LLDP MIB changes. (Range: 5-3600 seconds; Default: 5 seconds)  
This parameter only applies to SNMP applications which use data stored in the LLDP MIB for network monitoring or management.  
Information about changes in LLDP neighbors that occur between SNMP notifications is not transmitted. Only state changes that exist at the time of a notification are included in the transmission. An SNMP agent should therefore periodically check the value of `IldpStatsRemTableLastChangeTime` to detect any

### 3 Configuring the Switch

lldpRemTablesChange notification-events missed due to throttling or transmission loss.

- **MED Fast Start Count** – Configures the amount of LLDP MED Fast Start LLDPDUs to transmit during the activation process of the LLDP-MED Fast Start mechanism. (Range: 1-10 packets; Default: 4 packets)

The MED Fast Start Count parameter is part of the timer which ensures that the LLDP-MED Fast Start mechanism is active for the port. LLDP-MED Fast Start is critical to the timely startup of LLDP, and therefore integral to the rapid availability of Emergency Call Service.

**Web** – Click LLDP, Configuration. Enable LLDP, modify any of the timing parameters as required, and click Apply.

LLDP Configuration	
LLDP	<input type="checkbox"/> Enabled
Transmission Interval (5-32768)	30 seconds
Hold time Multiplier (2-10)	4
Delay Interval (1-8192)	2 seconds
Reinitialization Delay (1-10)	2 seconds
Notification Interval (5-3600)	5 seconds
MED Fast Start Count (1-10)	4 counts

Note: The Transmission Interval must be greater than or equal to 4 times delay interval.

Figure 3-124 LLDP Configuration

**CLI** – This example sets several attributes which control basic LLDP message timing.

```
Console(config)#lldp 4-286
Console(config)#lldp refresh-interval 60 4-288
Console(config)#lldp holdtime-multiplier 10 4-286
Console(config)#lldp tx-delay 10 4-289
Console(config)#lldp reinit-delay 10 4-288
Console(config)#lldp notification-interval 30 4-287
Console(config)#lldp medFastStartCount 6 4-287
Console(config)#exit
Console#show lldp config 4-301

LLDP Global Configuration

LLDP Enable : Yes
LLDP Transmit interval : 60
LLDP Hold Time Multiplier : 10
LLDP Delay Interval : 10
LLDP Reinit Delay : 10
LLDP Notification Interval : 30
:
```

## Configuring LLDP Interface Attributes

Use the LLDP Port/Trunk Configuration to specify the message attributes for individual interfaces, including whether messages are transmitted, received, or both transmitted and received, whether SNMP notifications are sent, and the type of information advertised.

### Command Attributes

- **Admin Status** – Enables LLDP message transmit and receive modes for LLDP Protocol Data Units. (Options: Tx only, Rx only, TxRx, Disabled; Default: TxRx)
- **SNMP Notification** – Enables the transmission of SNMP trap notifications about LLDP and LLDP-MED changes. (Default: Enabled)

This option sends out SNMP trap notifications to designated target stations at the interval specified by the Notification Interval in the preceding section. Trap notifications include information about state changes in the LLDP MIB (IEEE 802.1AB), the LLDP-MED MIB (ANSI/TIA-1057), or vendor-specific LLDP-EXT-DOT1 and LLDP-EXT-DOT3 MIBs.

For information on defining SNMP trap destinations, see “Specifying Trap Managers and Trap Types” on page 3-43.

Information about additional changes in LLDP neighbors that occur between SNMP notifications is not transmitted. Only state changes that exist at the time of a trap notification are included in the transmission. An SNMP agent should therefore periodically check the value of `IldpStatsRemTableLastChangeTime` to detect any `IldpRemTablesChange` notification-events missed due to throttling or transmission loss.

- **TLV Type** – Configures the information included in the TLV field of advertised messages.
  - **Port Description** – The port description is taken from the `ifDescr` object in RFC 2863, which includes information about the manufacturer, the product name, and the version of the interface hardware/software.
  - **System Description** – The system description is taken from the `sysDescr` object in RFC 3418, which includes the full name and version identification of the system's hardware type, software operating system, and networking software.
  - **Management Address** – The management address protocol packet includes the IPv4 address of the switch. If no management address is available, the address should be the MAC address for the CPU or for the port sending this advertisement.

The management address TLV may also include information about the specific interface associated with this address, and an object identifier indicating the type of hardware component or protocol entity associated with this address. The interface number and OID are included to assist SNMP applications in the performance of network discovery by indicating enterprise specific or other starting points for the search, such as the Interface or Entity MIB.

Since there are typically a number of different addresses associated with a Layer 3 device, an individual LLDP PDU may contain more than one management address TLV.

### 3 Configuring the Switch

Every management address TLV that reports an address that is accessible on a port and protocol VLAN through the particular port should be accompanied by a port and protocol VLAN TLV that indicates the VLAN identifier (VID) associated with the management address reported by this TLV.

- **System Name** – The system name is taken from the sysName object in RFC 3418, which contains the system’s administratively assigned name. To configure the system name, see “Displaying System Information” on page 3-12.
- **System Capabilities** – The system capabilities identifies the primary function(s) of the system and whether or not these primary functions are enabled. The information advertised by this TLV is described in IEEE 802.1AB.
- **MED TLV Type** – Configures the information included in the MED TLV field of advertised messages.
  - **Port Capabilities** – This option advertises LLDP-MED TLV capabilities, allowing Media Endpoint and Connectivity Devices to efficiently discover which LLDP-MED related TLVs are supported on the switch.
  - **Network Policy** – This option advertises network policy configuration information, aiding in the discovery and diagnosis of VLAN configuration mismatches on a port. Improper network policy configurations frequently result in voice quality degradation or complete service disruption.
  - **Location** – This option advertises location identification details.
  - **Extended Power** – This option advertises extended Power-over-Ethernet capability details, such as power availability from the switch, and power state of the switch, including whether the switch is operating from primary or backup power (the Endpoint Device could use this information to decide to enter power conservation mode). Note that this device does not support PoE capabilities.
  - **Inventory** – This option advertises device details useful for inventory management, such as manufacturer, model, software version and other pertinent information.
- **MED Notification** – Enables the transmission of SNMP trap notifications about LLDP-MED changes. (Default: Enabled)
- **Trunk** – The trunk identifier. (Port Information only)

**Web** – Click LLDP, Port/Trunk Configuration. Set the LLDP transmit/receive mode, specify whether or not to send SNMP trap messages, select the information to advertise in LLDP messages, select the information to advertise in MED-TLV messages and specify whether or not to send MED notifications. Then click Apply.

LLDP Port Configuration								
Port	Admin Status	SNMP Notification	TLV Type		MED TLV Type		MED Notification	Trunk
1	TxRx	<input checked="" type="checkbox"/> Enabled	<input checked="" type="checkbox"/> Port Description <input checked="" type="checkbox"/> System Description <input checked="" type="checkbox"/> Management Address	<input checked="" type="checkbox"/> System Name <input checked="" type="checkbox"/> System Capabilities	<input checked="" type="checkbox"/> Port Capabilities <input checked="" type="checkbox"/> Network Policy <input checked="" type="checkbox"/> Location	<input checked="" type="checkbox"/> Extended Power <input checked="" type="checkbox"/> Inventory	<input checked="" type="checkbox"/> Enabled	
2	TxRx	<input checked="" type="checkbox"/> Enabled	<input checked="" type="checkbox"/> Port Description <input checked="" type="checkbox"/> System Description <input checked="" type="checkbox"/> Management Address	<input checked="" type="checkbox"/> System Name <input checked="" type="checkbox"/> System Capabilities	<input checked="" type="checkbox"/> Port Capabilities <input checked="" type="checkbox"/> Network Policy <input checked="" type="checkbox"/> Location	<input checked="" type="checkbox"/> Extended Power <input checked="" type="checkbox"/> Inventory	<input checked="" type="checkbox"/> Enabled	
3	Tx only	<input type="checkbox"/> Enabled	<input type="checkbox"/> Port Description <input type="checkbox"/> System Description <input type="checkbox"/> Management Address	<input type="checkbox"/> System Name <input type="checkbox"/> System Capabilities	<input checked="" type="checkbox"/> Port Capabilities <input checked="" type="checkbox"/> Network Policy <input checked="" type="checkbox"/> Location	<input checked="" type="checkbox"/> Extended Power <input checked="" type="checkbox"/> Inventory	<input checked="" type="checkbox"/> Enabled	1

Figure 3-125 LLDP Port Configuration

**CLI** – This example sets the interface to both transmit and receive LLDP messages, enables SNMP trap messages, enables MED notification, and specifies the TLV, MED-TLV, dot1-TLV and dot3-TLV parameters to advertise.

```

Console(config)#interface ethernet 1/1 4-187
Console(config-if)#lldp admin-status tx-rx 4-290
Console(config-if)#lldp notification 4-290
Console(config-if)#lldp medNotification 4-291
Console(config-if)#lldp basic-tlv port-description 4-292
Console(config-if)#lldp basic-tlv system-description 4-293
Console(config-if)#lldp basic-tlv management-ip-address 4-292
Console(config-if)#lldp basic-tlv system-name 4-294
Console(config-if)#lldp basic-tlv system-capabilities 4-293
Console(config-if)#lldp medtlv extPoe 4-298
Console(config-if)#lldp medtlv inventory 4-299
Console(config-if)#lldp medtlv location 4-299
Console(config-if)#lldp medtlv med-cap 4-300
Console(config-if)#lldp medtlv network-policy 4-300
Console(config-if)#lldp dot1-tlv proto-ident 4-294
Console(config-if)#lldp dot1-tlv proto-vid 4-295
Console(config-if)#lldp dot1-tlv pvid 4-295
Console(config-if)#lldp dot1-tlv vlan-name 4-296
Console(config-if)#lldp dot3-tlv link-agg 4-296
Console(config-if)#lldp dot3-tlv mac-phy 4-297
Console(config-if)#lldp dot3-tlv max-frame 4-297
Console(config-if)#lldp dot3-tlv poe 4-298
Console(config-if)#

```

## Displaying LLDP Local Device Information

Use the LLDP Local Device Information screen to display information about the switch, such as its MAC address, chassis ID, management IP address, and port information.

### Field Attributes

#### Global Settings

- **Chassis Type** – Identifies the chassis containing the IEEE 802 LAN entity associated with the transmitting LLDP agent. There are several ways in which a chassis may be identified and a chassis ID subtype is used to indicate the type of component being referenced by the chassis ID field.

Table 3-15 Chassis ID Subtype	
ID Basis	Reference
Chassis component	EntPhysicalAlias when entPhysClass has a value of 'chassis(3)' (IETF RFC 2737)
Interface alias	IfAlias (IETF RFC 2863)
Port component	EntPhysicalAlias when entPhysicalClass has a value 'port(10)' or 'backplane(4)' (IETF RFC 2737)
MAC address	MAC address (IEEE Std 802-2001)
Network address	networkAddress
Interface name	ifName (IETF RFC 2863)
Locally assigned	locally assigned

- **Chassis ID** – An octet string indicating the specific identifier for the particular chassis in this system.
- **System Name** – A string that indicates the system's administratively assigned name (see "Displaying System Information" on page 3-12).
- **System Description** – A textual description of the network entity. This field is also displayed by the **show system** command.
- **System Capabilities Supported** – The capabilities that define the primary function(s) of the system.

Table 3-16 System Capabilities	
ID Basis	Reference
Other	—
Repeater	IETF RFC 2108
Bridge	IETF RFC 2674
WLAN Access Point	IEEE 802.11 MIB
Router	IETF RFC 1812
Telephone	IETF RFC 2011
DOCSIS cable device	IETF RFC 2669 and IETF RFC 2670
End Station Only	IETF RFC 2011



- **System Capabilities Enabled** – The primary function(s) of the system which are currently enabled. Refer to the preceding table.
- **Management Address** – The management address protocol packet includes the IPv4 address of the switch. If no management address is available, the address should be the MAC address for the CPU or for the port sending this advertisement.

### Interface Settings

The attributes listed below apply to both port and trunk interface types. When a trunk is listed, the descriptions apply to the first port of the trunk.

- **Port Description** – A string that indicates the port's description. If RFC 2863 is implemented, the ifDescr object should be used for this field.
- **Port ID** – A string that contains the specific identifier for the port from which this LLDPDU was transmitted.

**Web** – Click LLDP, Local Information.

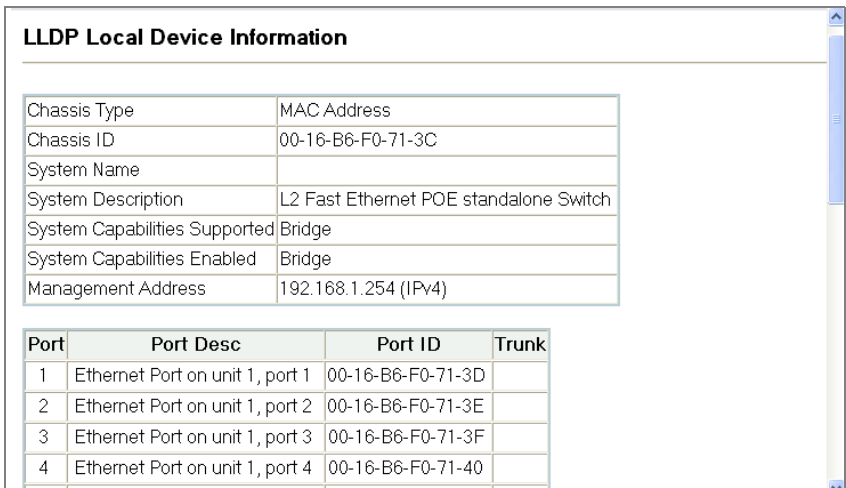

The screenshot shows a window titled "LLDP Local Device Information". It contains two tables. The first table lists system-level information, and the second table lists port-level information.

LLDP Local Device Information	
Chassis Type	MAC Address
Chassis ID	00-16-B6-F0-71-3C
System Name	
System Description	L2 Fast Ethernet POE standalone Switch
System Capabilities Supported	Bridge
System Capabilities Enabled	Bridge
Management Address	192.168.1.254 (IPv4)

Port	Port Desc	Port ID	Trunk
1	Ethernet Port on unit 1, port 1	00-16-B6-F0-71-3D	
2	Ethernet Port on unit 1, port 2	00-16-B6-F0-71-3E	
3	Ethernet Port on unit 1, port 3	00-16-B6-F0-71-3F	
4	Ethernet Port on unit 1, port 4	00-16-B6-F0-71-40	

Figure 3-126 LLDP Local Device Information

### 3 Configuring the Switch

**CLI** – This example displays LLDP information for the local switch.

```
Console#show lldp info local-device 4-303

LLDP Local System Information
Chassis Type : MAC Address
Chassis ID   : 00-01-02-03-04-05
System Name  :
System Description : 24 10/100 ports and 4 gigabit ports with PoE switch
System Capabilities Support : Bridge
System Capabilities Enable : Bridge
Management Address : 192.168.0.101 (IPv4)

LLDP Port Information
Interface |PortID Type          PortID          PortDesc
-----+-----+-----+-----
Eth 1/1  |MAC Address         00-01-02-03-04-06 Ethernet Port on unit 1, port 1
Eth 1/2  |MAC Address         00-01-02-03-04-07 Ethernet Port on unit 1, port 2
Eth 1/3  |MAC Address         00-01-02-03-04-08 Ethernet Port on unit 1, port 3
Eth 1/4  |MAC Address         00-01-02-03-04-09 Ethernet Port on unit 1, port 4
Eth 1/5  |MAC Address         00-01-02-03-04-0A Ethernet Port on unit 1, port 5
:
```

This example displays detailed information for a specific port on the local switch.

```
Console#show lldp info local-device ethernet 1/1 4-303

LLDP Port Information Detail

Port      : Eth 1/1
Port Type : MAC Address
Port ID   : 00-01-02-03-04-06
Port Desc : Ethernet Port on unit 1, port 1

Console#
```

## Displaying LLDP Remote Port Information

Use the LLDP Remote Port/Trunk Information screen to display information about devices connected directly to the switch's ports which are advertising information through LLDP.

### Field Attributes

- **Local Port** – The local port to which a remote LLDP-capable device is attached.
- **Chassis ID** – An octet string indicating the specific identifier for the particular chassis in this system.
- **Port ID** – A string that contains the specific identifier for the port from which this LLDPDU was transmitted.
- **Port Name** – A string that indicates the port's description. If RFC 2863 is implemented, the ifDescr object should be used for this field.
- **System Name** – An string that indicates the system's administratively assigned name.

**Web** – Click LLDP, Remote Port/Trunk Information.

LLDP Port Remote Device Information				
Local Port	Chassis ID	Port ID	Port Name	System Name
1	00-01-02-03-04-05	00-01-02-03-04-06	Ethernet Port on unit 1, port 1	

Figure 3-127 LLDP Remote Port Information

**CLI** – This example displays LLDP information for remote devices attached to this switch which are advertising information through LLDP.

```

Console#show lldp info remote-device                               4-304

LLDP Remote Devices Information

Interface | ChassisId           PortId           SysName
-----+-----
Eth 1/1  | 00-01-02-03-04-05  00-01-02-03-04-06

Console#
  
```

## Displaying LLDP Remote Information Details

Use the LLDP Remote Information Details screen to display detailed information about an LLDP-enabled device connected to a specific port on the local switch.

### Field Attributes

- **Local Port** – The local port to which a remote LLDP-capable device is attached.
- **Chassis Type** – Identifies the chassis containing the IEEE 802 LAN entity associated with the transmitting LLDP agent. There are several ways in which a chassis may be identified and a chassis ID subtype is used to indicate the type of component being referenced by the chassis ID field. (See Table 3-15, “Chassis ID Subtype,” on page 218.)
- **Chassis ID** – An octet string indicating the specific identifier for the particular chassis in this system.
- **Port Type** – Indicates the basis for the identifier that is listed in the Port ID field.

Table 3-17 Port ID Subtype	
ID Basis	Reference
Interface alias	IfAlias (IETF RFC 2863)
Chassis component	EntPhysicalAlias when entPhysClass has a value of 'chassis(3)' (IETF RFC 2737)
Port component	EntPhysicalAlias when entPhysicalClass has a value 'port(10)' or 'backplane(4)' (IETF RFC 2737)
MAC address	MAC address (IEEE Std 802-2001)
Network address	networkAddress
Interface name	ifName (IETF RFC 2863)

### 3 Configuring the Switch

Table 3-17 Port ID Subtype (Continued)	
ID Basis	Reference
Agent circuit ID	agent circuit ID (IETF RFC 3046)
Locally assigned	locally assigned

- **Port Description** – A string that indicates the port’s description. If RFC 2863 is implemented, the ifDescr object should be used for this field.
- **Port ID** – A string that contains the specific identifier for the port from which this LLDPDU was transmitted.
- **System Name** – An string that indicates the system’s configured assigned name.
- **System Description** – A textual description of the network entity.
- **System Capabilities Supported** – The capabilities that define the primary function(s) of the system. (See Table 3-16, “System Capabilities,” on page 218.)
- **System Capabilities Enabled** – The primary function(s) of the system which are currently enabled. Refer to the preceding table. (See Table 3-16, “System Capabilities,” on page 218.)
- **Management Address** – The IPv4 address of the remote device. If no management address is available, the address should be the MAC address for the CPU or for the port sending this advertisement.

**Web** – Click LLDP, Remote Information Details. Select an interface from the drop down lists, and click Query.

### LLDP Remote Device Information Detail

---

Interface  Port 1  Trunk

Local Port	1
Chassis Type	MAC Address
Chassis ID	00-01-02-03-04-05
Port Type	MAC Address
Port Description	Ethernet Port on unit 1, port 1
Port ID	00-01-02-03-04-06
System Name	
System Description	iBG2006
System Capabilities Supported	Bridge
System Capabilities Enabled	Bridge
Management Address	192.168.0.101 (IPv4)

Figure 3-128 LLDP Remote Information Details

**CLI** – This example displays LLDP information for an LLDP-enabled remote device attached to a specific port on this switch.

```

Console#show lldp info remote-device detail ethernet 1/1          4-304

LLDP Remote Devices Information Detail
-----
Local PortName       : Eth 1/1
Chassis Type        : MAC Address
Chassis Id          : 00-01-02-03-04-05
PortID Type         : MAC Address
PortID              : 00-01-02-03-04-06
SysName             :
SysDescr            : L2 Fast Ethernet POE standalone Switch
PortDescr           : Ethernet Port on unit 1, port 1
SystemCapSupported  : Bridge
SystemCapEnabled    : Bridge
Remote Management Address :
                    00-01-02-03-04-05 (MAC Address)

Console#

```

## Displaying Device Statistics

Use the LLDP Device Statistics screen to general statistics for LLDP-capable devices attached to the switch, and for LLDP protocol messages transmitted or received on all local interfaces.

### Field Attributes

#### *General Statistics on Remote Devices*

- **Neighbor Entries List Last Updated** – The time the LLDP neighbor entry list was last updated.
- **New Neighbor Entries Count** – The number of LLDP neighbors for which the remote TTL has not yet expired.
- **Neighbor Entries Deleted Count** – The number of LLDP neighbors which have been removed from the LLDP remote systems MIB for any reason.
- **Neighbor Entries Dropped Count** – The number of times which the local remote database dropped an LLDPDU because of insufficient resources.
- **Neighbor Entries Age-out Count** – The number of times that a neighbor's information has been deleted from the LLDP remote systems MIB because the remote TTL timer has expired.

#### *Interface Statistics on LLDP Protocol Messages*

- **Num Frames Recvd** – Number of LLDP PDUs received.
- **Num Frames Sent** – Number of LLDP PDUs transmitted.
- **Num Frames Discarded** – Number of frames discarded because they did not conform to the general validation rules as well as any specific usage rules defined for the particular TLV.

### 3 Configuring the Switch

**Web** – Click LLDP, Device Statistics.

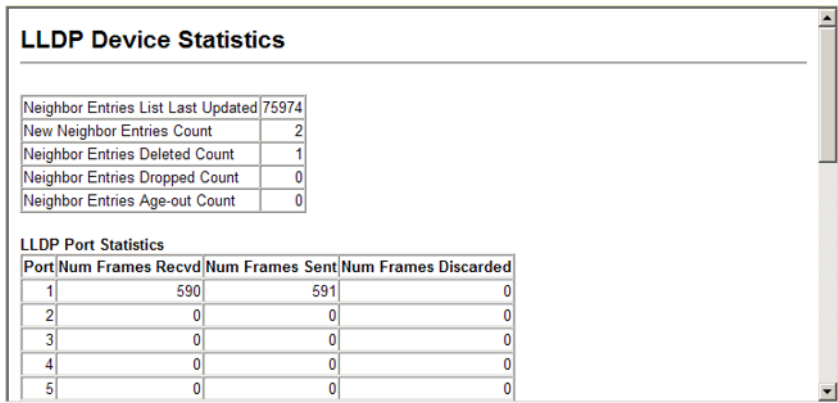

The screenshot shows a web interface titled "LLDP Device Statistics". It contains two tables. The first table shows summary statistics for LLDP neighbor entries. The second table shows LLDP port statistics for ports 1 through 5.

LLDP Device Statistics	
Neighbor Entries List Last Updated	75974
New Neighbor Entries Count	2
Neighbor Entries Deleted Count	1
Neighbor Entries Dropped Count	0
Neighbor Entries Age-out Count	0

LLDP Port Statistics			
Port	Num Frames Recvd	Num Frames Sent	Num Frames Discarded
1	590	591	0
2	0	0	0
3	0	0	0
4	0	0	0
5	0	0	0

**Figure 3-129 LLDP Device Statistics**

**CLI** – This example displays LLDP statistics received from all LLDP-enabled remote devices connected directly to this switch.

```
switch#show lldp info statistics 4-305  
  
LLDP Device Statistics  
  
Neighbor Entries List Last Updated : 2450279 seconds  
New Neighbor Entries Count       : 1  
Neighbor Entries Deleted Count   : 0  
Neighbor Entries Dropped Count   : 0  
Neighbor Entries Ageout Count    : 0  
  
Interface | NumFramesRecvd NumFramesSent NumFramesDiscarded  
-----+-----  
Eth 1/1   | 10              11              0  
Eth 1/2   | 0               0               0  
Eth 1/3   | 0               0               0  
Eth 1/4   | 0               0               0  
Eth 1/5   | 0               0               0  
:  
:
```

## Displaying Detailed Device Statistics

Use the LLDP Device Statistics Details screen to display statistics based on traffic received through all attached LLDP-enabled interfaces.

### Field Attributes

- **Frames Discarded** – Number of frames discarded because they did not conform to the general validation rules as well as any specific usage rules defined for the particular TLV.
- **Frames Invalid** – A count of all LLDPDUs received with one or more detectable errors.
- **Frames Received** – Number of LLDP PDUs received.
- **Frames Sent** – Number of LLDP PDUs transmitted.
- **TLVs Unrecognized** – A count of all TLVs not recognized by the receiving LLDP local agent.
- **TLVs Discarded** – A count of all LLDPDUs received and then discarded due to insufficient memory space, missing or out-of-sequence attributes, or any other reason.
- **Neighbor Ageouts** – A count of the times that a neighbor's information has been deleted from the LLDP remote systems MIB because the remote TTL timer has expired.

**Web** – Click LLDP, Device Statistics Details.

### LLDP Device Statistics Detail

---

Interface  Port 1  Trunk

Query

Frames Discarded	0
Frames Invalid	0
Frames Received	114
Frames Sent	114
TLVs Unrecognized	0
TLVs Discarded	0
Neighbor Ageouts	0

Refresh

Figure 3-130 LLDP Device Statistics Details

### 3 Configuring the Switch

**CLI** – This example displays detailed LLDP statistics for an LLDP-enabled remote device attached to a specific port on this switch.

```
switch#show lldp info statistics detail ethernet 1/1 4-305

LLDP Port Statistics Detail

PortName           : Eth 1/1
Frames Discarded   : 0
Frames Invalid     : 0
Frames Received    : 12
Frames Sent        : 13
TLVs Unrecognized : 0
TLVs Discarded    : 0
Neighbor Ageouts  : 0

switch#
```

## Class of Service Configuration

Class of Service (CoS) allows you to specify which data packets have greater precedence when traffic is buffered in the switch due to congestion. This switch supports CoS with four priority queues for each port. Data packets in a port's high-priority queue will be transmitted before those in the lower-priority queues. You can set the default priority for each interface, and configure the mapping of frame priority tags to the switch's priority queues.

## Layer 2 Queue Settings

### Setting the Default Priority for Interfaces

You can specify the default port priority for each interface on the switch. All untagged packets entering the switch are tagged with the specified default port priority, and then sorted into the appropriate priority queue at the output port.

#### Command Usage

- This switch provides four priority queues for each port. It uses Weighted Round Robin to prevent head-of-queue blockage.
- The default priority applies for an untagged frame received on a port set to accept all frame types (i.e., receives both untagged and tagged frames). This priority does not apply to IEEE 802.1Q VLAN tagged frames. If the incoming frame is an IEEE 802.1Q VLAN tagged frame, the IEEE 802.1p User Priority bits will be used.
- If the output port is an untagged member of the associated VLAN, these frames are stripped of all VLAN tags prior to transmission.



### Command Attributes

- **Default Priority**<sup>18</sup> – The priority that is assigned to untagged frames received on the specified interface. (Range: 0-7; Default: 0)
- **Number of Egress Traffic Classes** – The number of queue buffers provided for each port.

**Web** – Click Priority, Default Port Priority or Default Trunk Priority. Modify the default priority for any interface, then click Apply.

Default Port Priority			
Port	Default Priority (0-7)	Number of Egress Traffic Classes	Trunk
1	0	4	
2	0	4	
3	0	4	
4	0	4	
5	0	4	
6	0	4	
7	0	4	

Figure 3-131 Port Priority Configuration

**CLI** – This example assigns a default priority of 5 to port 3.

```

Console(config)#interface ethernet 1/3                               4-187
Console(config-if)#switchport priority default 5                   4-307
Console(config-if)#end
Console#show interfaces switchport ethernet 1/3                   4-199
Information of Eth 1/3
Broadcast Threshold:      Enabled, 64 Kbits/second
Multicast Threshold:     Disabled
Unknown-unicast Threshold: Disabled
LACP Status:             Disabled
Ingress Rate Limit:      Disabled, 100000 Kbits per second
Egress Rate Limit:       Disabled, 100000 Kbits per second
VLAN Membership Mode:    Hybrid
Ingress Rule:            Enabled
Acceptable Frame Type:   All frames
Native VLAN:             1
Priority for Untagged Traffic: 0
GVRP Status:            Disabled
Allowed VLAN:            1 (u), 4093 (t),
Forbidden VLAN:
Private-VLAN Mode:      NONE
Private-VLAN host-association: NONE
Private-VLAN Mapping:   NONE
802.1Q-tunnel Status:   Disable
802.1Q-tunnel Mode:     NORMAL
802.1Q-tunnel TPID:     8100 (Hex)
Console#

```

18. CLI displays this information as "Priority for untagged traffic."

## Mapping CoS Values to Egress Queues

This switch processes Class of Service (CoS) priority tagged traffic by using four priority queues for each port, with service schedules based on strict or Weighted Round Robin (WRR). Up to eight separate traffic priorities are defined in IEEE 802.1p. The default priority levels are assigned according to recommendations in the IEEE 802.1p standard as shown in the following table.

Table 3-18 Mapping CoS Values to Egress Queues

Queue	0	1	2	3
Priority	1,2	0,3	4,5	6,7

The priority levels recommended in the IEEE 802.1p standard for various network applications are shown in the following table. However, you can map the priority levels to the switch's output queues in any way that benefits application traffic for your own network.

Table 3-19 CoS Priority Levels

Priority Level	Traffic Type
1	Background
2	(Spare)
0 (default)	Best Effort
3	Excellent Effort
4	Controlled Load
5	Video, less than 100 milliseconds latency and jitter
6	Voice, less than 10 milliseconds latency and jitter
7	Network Control

### Command Attributes

- **Priority** – CoS value. (Range: 0-7, where 7 is the highest priority)
- **Traffic Class**<sup>19</sup> – Output queue buffer. (Range: 0-3, where 3 is the highest CoS priority queue)

---

19. CLI shows Queue ID.

**Web** – Click Priority, Traffic Classes. The current mapping of CoS values to output queues is displayed. Assign priorities to the traffic classes (i.e., output queues), then click Apply.

Traffic Classes	
Priority	Traffic Class
0	1 (0-3)
1	0 (0-3)
2	0 (0-3)
3	1 (0-3)
4	2 (0-3)
5	2 (0-3)
6	3 (0-3)
7	3 (0-3)

Figure 3-132 Traffic Classes

**CLI** – The following example shows how to change the CoS assignments.

```

Console(config)#interface ethernet 1/1                               4-187
Console(config-if)#queue cos-map 0 0                               4-308
Console(config-if)#queue cos-map 1 1
Console(config-if)#queue cos-map 2 2
Console(config-if)#end
Console#show queue cos-map ethernet 1/1                             4-310
Information of Eth 1/1
  CoS Value:      0 1 2 3 4 5 6 7
  Priority Queue: 0 1 2 1 2 2 3 3
Console#

```

\* Mapping specific values for CoS priorities is implemented as an interface configuration command, but any changes will apply to the all interfaces on the switch.

### 3 Configuring the Switch

#### Selecting the Queue Mode

You can set the switch to service the queues based on a strict rule that requires all traffic in a higher priority queue to be processed before lower priority queues are serviced, or use Weighted Round-Robin (WRR) queuing that specifies a relative weight of each queue.

#### Command Usage

- Strict priority requires all traffic in a higher priority queue to be processed before lower priority queues are serviced.
- WRR uses a relative weighting for each queue which determines the amount of packets the switch transmits every time it services each queue before moving on to the next queue. Thus, a queue weighted 8 will be allowed to transmit up to 8 packets, after which the next lower priority queue will be serviced according to its weighting. This prevents the head-of-line blocking that can occur with strict priority queuing.

#### Command Attributes

- **WRR** - Weighted Round-Robin shares bandwidth at the egress ports by using scheduling weights with default values of 1, 2, 4, 8 for queues 0 through 3, respectively. (This is the default selection.)
- **Strict** - Services the egress queues in sequential order, transmitting all traffic in the higher priority queues before servicing lower priority queues.

**Web** – Click Priority, Queue Mode. Select Strict or WRR, then click Apply.



Figure 3-133 Queue Mode

**CLI** – The following sets the queue mode to strict priority service mode.

```
Console(config)#queue mode strict          4-306
Console(config)#exit
Console#show queue mode                    4-309
Queue mode: strict
```

#### Setting the Service Weight for Traffic Classes

This switch uses the Weighted Round Robin (WRR) algorithm to determine the frequency at which it services each priority queue. As described in “Mapping CoS Values to Egress Queues” on page 3-228, the traffic classes are mapped to one of the four egress queues provided for each port. This weight sets the limit for the number of packets the switch will transmit each time the queue is serviced, and subsequently affects the response time for software applications assigned a specific priority value.

**Note:** This switch does not allow the queue service weights to be set. The weights are fixed as 1, 2, 4, 8, for queues 0 through 3 respectively.

### Command Attributes

- **WRR Setting Table**<sup>20</sup> – Displays a list of weights for each traffic class (i.e., queue).
- **Weight Value** – Set a new weight for the selected traffic class. (Range: 1-15)

**Web** – Click Priority, Queue Scheduling.

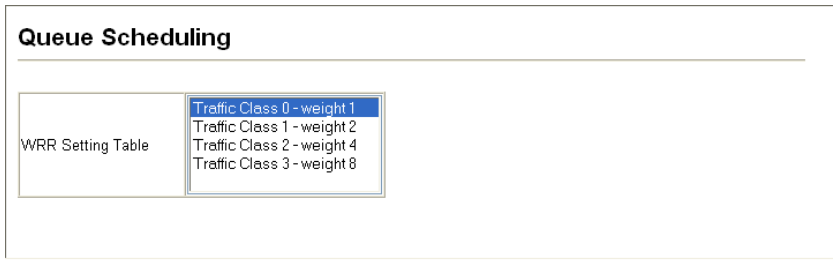

Figure 3-134 Configuring Queue Scheduling

**CLI** – The following example shows how to display the WRR weights assigned to each of the priority queues.

```

Console#show queuee bandwidth                               4-309
Queue ID  Weight
-----  -
0         1
1         2
2         4
3         8
Console
  
```

## Layer 3/4 Priority Settings

### Mapping Layer 3/4 Priorities to CoS Values

This switch supports one method of prioritizing layer 3/4 traffic to meet application requirements. Traffic priorities can be specified in the IP header of a frame, using the priority bits in the Type of Service (TOS) octet or the number of the TCP port. If the priority bits are used, the TOS octet may contain six bits for Differentiated Services Code Point (DSCP) service. When these service is enabled, the priorities are mapped to a Class of Service value by the switch, and the traffic then sent to the corresponding output queue.

Because different priority information may be contained in the traffic, this switch maps priority values to the output queues in the following manner – The precedence for priority mapping is IP DSCP Priority and then Default Port Priority.

<sup>20</sup>. CLI shows Queue ID.

### 3 Configuring the Switch

#### Enabling IP DSCP Priority

The switch allows you to enable or disable the IP DSCP priority.

#### Command Attributes

- **IP DSCP Priority Status** – The following options are:
  - **Disabled** – Disables the priority service. (Default Setting: Disabled)
  - **IP DSCP** – Maps layer 3/4 priorities using Differentiated Services Code Point Mapping.

**Web** – Click Priority, IP DSCP Priority Status. Select IP DSCP from the drop down menu, then click Apply.

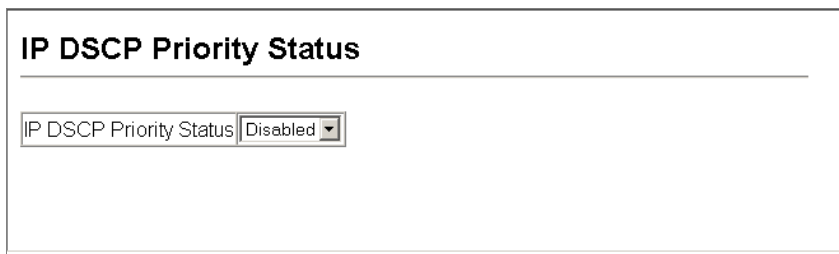

IP DSCP Priority Status

IP DSCP Priority Status

Figure 3-135 IP DSCP Priority Status

**CLI** – The following example globally enables DSCP Priority service on the switch.

```
Console(config)#map ip dscp 4-311
Console(config)#end
Console#show map ip dscp 4-312
dscp Mapping Status: Enabled

  DSCP COS
  ---- ---
    0    1
    1    0
    2    0
    3    0
  :
```

## Mapping DSCP Priority

The DSCP is six bits wide, allowing coding for up to 64 different forwarding behaviors. The DSCP retains backward compatibility with the three precedence bits so that non-DSCP compliant devices will not conflict with the DSCP mapping. Based on network policies, different kinds of traffic can be marked for different kinds of forwarding. The DSCP default values are defined in the following table. Note that all the DSCP values that are not specified are mapped to CoS value 0.

**Table 3-20 Mapping DSCP Priority Values**

IP DSCP Value	CoS Value
0	0
8	1
10, 12, 14, 16	2
18, 20, 22, 24	3
26, 28, 30, 32, 34, 36	4
38, 40, 42	5
48	6
46, 56	7

### Command Attributes

- **DSCP Priority Table** – Shows the DSCP Priority to CoS map.
- **Class of Service Value** – Maps the selected DSCP Priority value a CoS value. Note that “0” represents low priority and “7” represent high priority.

**Note:** IP DSCP settings apply to all interfaces.

**Web** – Click Priority, IP DSCP Priority. Select an entry from the DSCP table, enter a value in the Class of Service Value field, then click Apply.

### IP DSCP Priority

---

DSCP Priority Table

DSCP 0 - CoS 0
DSCP 1 - CoS 0
DSCP 2 - CoS 0
DSCP 3 - CoS 0
DSCP 4 - CoS 0
DSCP 5 - CoS 0
DSCP 6 - CoS 0

Class of Service Value (0-7)

**Figure 3-136 Mapping IP DSCP Priority Values**

### 3 Configuring the Switch

**CLI** – The following example globally enables DSCP Priority service on the switch, maps DSCP value 0 to CoS value 1 (on port 1), and then displays the DSCP Priority settings.

```
Console(config)#map ip dscp 4-311
Console(config)#interface ethernet 1/1 4-187
Console(config-if)#map ip dscp 1 cos 0 4-311
Console(config-if)#end
Console#show map ip dscp ethernet 1/1 4-312
DSCP mapping status: disabled
```

Port	DSCP	COS
Eth 1/ 1	0	0
Eth 1/ 1	1	0
Eth 1/ 1	2	0
Eth 1/ 1	3	0
:		
Eth 1/ 1	61	0
Eth 1/ 1	62	0
Eth 1/ 1	63	0

```
Console#
```

\* Mapping specific values for IP DSCP is implemented as an interface configuration command, but any changes will apply to the all interfaces on the switch.

## Quality of Service

The commands described in this section are used to configure Quality of Service (QoS) classification criteria and service policies. Differentiated Services (DiffServ) provides policy-based management mechanisms used for prioritizing network resources to meet the requirements of specific traffic types on a per hop basis. Each packet is classified upon entry into the network based on access lists, IP Precedence, DSCP values, or VLAN lists. Using access lists allows you select traffic based on Layer 2, Layer 3, or Layer 4 information contained in each packet. Based on configured network policies, different kinds of traffic can be marked for different kinds of forwarding.

All switches or routers that access the Internet rely on class information to provide the same forwarding treatment to packets in the same class. Class information can be assigned by end hosts, or switches or routers along the path. Priority can then be assigned based on a general policy, or a detailed examination of the packet. However, note that detailed examination of packets should take place close to the network edge so that core switches and routers are not overloaded.

Switches and routers along the path can use class information to prioritize the resources allocated to different traffic classes. The manner in which an individual device handles traffic in the DiffServ architecture is called per-hop behavior. All devices along a path should be configured in a consistent manner to construct a consistent end-to-end QoS solution.

**Notes:** 1. You can configure up to 16 rules per Class Map. You can also include multiple classes in a Policy Map.



2. You should create a Class Map before creating a Policy Map. Otherwise, you will not be able to select a Class Map from the Policy Rule Settings screen (see page 3-240).

## Configuring Quality of Service Parameters

To create a service policy for a specific category or ingress traffic, follow these steps:

1. Use the “Class Map” to designate a class name for a specific category of traffic.
2. Edit the rules for each class to specify a type of traffic based on an access list, a DSCP or IP Precedence value, or a VLAN.
3. Use the “Policy Map” to designate a policy name for a specific manner in which ingress traffic will be handled.
4. Add one or more classes to the Policy Map. Assign policy rules to each class by “setting” the QoS value to be assigned to the matching traffic class. The policy rule can also be configured to monitor the average flow and burst rate, and drop any traffic that exceeds the specified rate, or just reduce the DSCP service level for traffic exceeding the specified rate.
5. Use the “Service Policy” to assign a policy map to a specific interface.

### Configuring a Class Map

A class map is used for matching packets to a specified class.

#### Command Usage

- To configure a Class Map, follow these steps:
  - Open the Class Map page, and click Add Class.
  - When the Class Configuration page opens, fill in the “Class Name” field, and click Add.
  - When the Match Class Settings page opens, specify type of traffic for this class based on an access list, a DSCP or IP Precedence value, or a VLAN, and click the Add button next to the field for the selected traffic criteria. You can specify up to 16 items to match when assigning ingress traffic to a class map.
- The class map is used with a policy map (page 3-238) to create a service policy (page 3-241) for a specific interface that defines packet classification, service tagging, and bandwidth policing. Note that one or more class maps can be assigned to a policy map.

#### Command Attributes

##### *Class Map*

- **Modify Name and Description** – Configures the name and a brief description of a class map. (Range: 1-16 characters for the name; 1-64 characters for the description)
- **Edit Rules** – Opens the “Match Class Settings” page for the selected class entry. Modify the criteria used to classify ingress traffic on this page.

### 3 Configuring the Switch

- **Add Class** – Opens the “Class Configuration” page. Enter a class name and description on this page, and click Add to open the “Match Class Settings” page. Enter the criteria used to classify ingress traffic on this page.
- **Remove Class** – Removes the selected class.

#### *Class Configuration*

- **Class Name** – Name of the class map. (Range: 1-16 characters)
- **Type** – Only one match command is permitted per class map, so the match-any field refers to the criteria specified by the lone match command.
- **Description** – A brief description of a class map. (Range: 1-64 characters)
- **Add** – Adds the specified class.
- **Back** – Returns to previous page with making any changes.

#### *Match Class Settings*

- **Class Name** – List of class maps.
- **ACL List** – Name of an access control list. Any type of ACL can be specified, including standard or extended IP ACLs and MAC ACLs. (Range: 1-16 characters)
- **IP DSCP** – A DSCP value. (Range: 0-63)
- **IP Precedence** – An IP Precedence value. (Range: 0-7)
- **VLAN** – A VLAN. (Range:1-4094)
- **Add** – Adds specified criteria to the class. Up to 16 items are permitted per class.
- **Remove** – Deletes the selected criteria from the class.

**Web** – Click QoS, DiffServ, then click Add Class to create a new class, or Edit Rules to change the rules of an existing class.

**Class Map**

Modify Name & Description   Edit Rules   Add Class   Remove Class

<input type="checkbox"/>	Class Name	Type	Description
<input type="checkbox"/>	Class Name	match-any	

**Class Configuration**

Class Name:

Type:

Description:

Add   Back

**Match Class Settings**

Class Name: **classname2**

**match-any**

Remove

ACL List:  Add

IP DSCP (0-63):  Add

IP Precedence (0-7):  Add

VLAN (1-4092):  Add

**Figure 3-137** Configuring Class Maps

**CLI** - This example creates a class map call “rd\_class,” and sets it to match packets marked for DSCP service value 3.

```

Console(config)#class-map rd_class match-any           4-314
Console(config-cmap)#match ip dscp 3                 4-315
Console(config-cmap)#

```

### Creating QoS Policies

This function creates a policy map that can be attached to multiple interfaces.

#### Command Usage

- To configure a Policy Map, follow these steps:
  - Create a Class Map as described on page 3-235.
  - Open the Policy Map page, and click Add Policy.
  - When the Policy Configuration page opens, fill in the “Policy Name” field, and click Add.
  - When the Policy Rule Settings page opens, select a class name from the scroll-down list (Class Name field). Configure a policy for traffic that matches criteria defined in this class by setting the quality of service that an IP packet will receive (in the Action field), defining the maximum throughput and burst rate (in the Meter field), and the action that results from a policy violation (in the Exceed field). Then finally click Add to register the new policy.
- A policy map can contain multiple class statements that can be applied to the same interface with the Service Policy Settings (page 3-241). You can configure up to 64 policers (i.e., meters or class maps) for each of the following access list types: MAC ACL, IP ACL (including Standard ACL and Extended ACL). Also, note that the maximum number of classes that can be applied to a policy map is 16.

Policing is based on a token bucket, where bucket depth (i.e., the maximum burst before the bucket overflows) is specified by the “Burst” field, and the average rate at which tokens are removed from the bucket is specified by the “Rate” option.
- After using the policy map to define packet classification, service tagging, and bandwidth policing, it must be assigned to a specific interface by a service policy (page 3-241) to take effect.

#### Command Attributes

##### *Policy Map*

- **Modify Name and Description** – Configures the name and a brief description of a policy map. (Range: 1-16 characters for the name; 1-64 characters for the description)
- **Edit Classes** – Opens the “Policy Rule Settings” page for the selected class entry. Modify the criteria used to service ingress traffic on this page.
- **Add Policy** – Opens the “Policy Configuration” page. Enter a policy name and description on this page, and click Add to open the “Policy Rule Settings” page. Enter the criteria used to service ingress traffic on this page.
- **Remove Policy** – Deletes a specified policy.

##### *Policy Configuration*

- **Policy Name** — Name of policy map. (Range: 1-16 characters)
- **Description** – A brief description of a policy map. (Range: 1-64 characters)
- **Add** – Adds the specified policy.
- **Back** – Returns to previous page with making any changes.

### *Policy Rule Settings*

#### *- Class Settings -*

- **Class Name** – Name of class map.
- **Action** – Shows the service provided to ingress traffic by setting a CoS, DSCP, or IP Precedence value in a matching packet (as specified in Match Class Settings on page 3-235).
- **Meter** – The maximum throughput and burst rate.
  - **Rate (kbps)** – Rate in kilobits per second.
  - **Burst (byte)** – Burst in bytes.
- **Exceed Action** – Specifies whether the traffic that exceeds the specified rate will be dropped or the DSCP service level will be reduced.
- **Remove Class** – Deletes a class.

#### *- Policy Options -*

- **Class Name** – Name of class map.
- **Action** – Configures the service provided to ingress traffic by setting a CoS or IP DSCP value in a matching packet (as specified in Match Class Settings on page 3-235). (Range - CoS: 0-7, DSCP: 0-63)
- **Meter** – Check this to define the maximum throughput, burst rate, and the action that results from a policy violation.
  - **Rate (kbps)** – Rate in kilobits per second. (Range: 1-100000 kbps or maximum port speed, whichever is lower)
  - **Burst (byte)** – Burst in bytes. (Range: 64-1522)
- **Exceed** – Specifies whether the traffic that exceeds the specified rate or burst will be dropped or the DSCP service level will be reduced.
  - **Set** – Decreases DSCP priority for out of conformance traffic. (Range: 0-63).
  - **Drop** – Drops out of conformance traffic.
- **Add** – Adds the specified criteria to the policy map.

### 3 Configuring the Switch

**Web** – Click QoS, DiffServ, Policy Map to display the list of existing policy maps. To add a new policy map click Add Policy. To configure the policy rule settings click Edit Classes.

**Policy Map**

Modify Name & Description   Edit Classes   Add Policy   Remove Policy

Policy Name	Description
<input type="checkbox"/> Policy	

**Policy Configuration**

Policy Name:

Description:

Add   Back

**Policy Rule Settings**

Policy Name: **Policy 2**

Class Name	Action	Meter		Exceed Action
		Rate (bps)	Burst (byte)	
<input type="text"/>				

Remove Class

Class Name:

Action:

Meter

Rate (1-100000):  kbps

Burst (64-1522):  byte

Exceed:

Add

Figure 3-138 Configuring Policy Maps

**CLI** – This example creates a policy map called “rd-policy,” sets the average bandwidth to 1 Mbps, the burst rate to 1522 bps, and the response to reduce the DSCP value for violating packets to 0.

```

Console(config)#policy-map rd_policy#3          4-316
Console(config-pmap)#class rd_class#3         4-317
Console(config-pmap-c)#set ip dscp 4          4-318
Console(config-pmap-c)#police 100000 1522 exceed-action
  set ip dscp 0                                4-319
Console(config-pmap-c)#

```

### Attaching a Policy Map to Ingress Queues

This function binds a policy map to the ingress queue of a particular interface.

#### Command Usage

- You must first define a class map, then define a policy map, and finally bind the service policy to the required interface.
- You can only bind one policy map to an interface.
- The current firmware does not allow you to bind a policy map to an egress queue.

#### Command Attributes

- **Ports** – Specifies a port.
- **Ingress** – Applies the rule to ingress traffic.
- **Enabled** – Check this to enable a policy map on the specified port.
- **Policy Map** – Select the appropriate policy map from the scroll-down box.

**Web** – Click QoS, DiffServ, Service Policy Settings. Check Enabled and choose a Policy Map for a port from the scroll-down box, then click Apply.

Ports	Ingress
1	<input type="checkbox"/> Enabled   Policy ▾
2	<input type="checkbox"/> Enabled   Policy ▾
3	<input type="checkbox"/> Enabled   Policy ▾
4	<input type="checkbox"/> Enabled   Policy ▾
5	<input type="checkbox"/> Enabled   Policy ▾
6	<input type="checkbox"/> Enabled   Policy ▾
7	<input type="checkbox"/> Enabled   Policy ▾
8	<input type="checkbox"/> Enabled   Policy ▾
9	<input type="checkbox"/> Enabled   Policy ▾
10	<input type="checkbox"/> Enabled   Policy ▾

Figure 3-139 Service Policy Settings

**CLI** - This example applies a service policy to an ingress interface.

```

Console(config)#interface ethernet 1/5          4-187
Console(config-if)#service-policy input rd_policy#3  4-320
Console(config-if)#

```

### VoIP Traffic Configuration

When IP telephony is deployed in an enterprise network, it is recommended to isolate the Voice over IP (VoIP) network traffic from other data traffic. Traffic isolation can provide higher voice quality by preventing excessive packet delays, packet loss, and jitter. This is best achieved by assigning all VoIP traffic to a single Voice VLAN.

The use of a Voice VLAN has several advantages. It provides security by isolating the VoIP traffic from other data traffic. End-to-end QoS policies and high priority can be applied to the VoIP VLAN traffic across the network, guaranteeing the bandwidth it needs. The VLAN isolation also protects against disruptive broadcast and multicast traffic that can seriously affect voice quality.

The switch allows you to specify a Voice VLAN for the network and set a CoS priority for the VoIP traffic. VoIP traffic can be detected on switch ports by using the source MAC address of packets, or by using LLDP (IEEE 802.1AB) to discover connected VoIP devices. When VoIP traffic is detected on a configured port, the switch automatically assigns the port as a tagged member the Voice VLAN. Alternatively, switch ports can be manually configured.

#### Configuring VoIP Traffic

To configure the switch for VoIP traffic, first enable the automatic detection of VoIP devices attached to switch ports, then set the Voice VLAN ID for the network. The Voice VLAN aging time can also be set to remove a port from the Voice VLAN when VoIP traffic is no longer received on the port.

##### Command Attributes

- **Auto Detection Status** – Enables the automatic detection of VoIP traffic on switch ports. (Default: Disabled)
- **Voice VLAN ID** – Sets the Voice VLAN ID for the network. Only one Voice VLAN is supported and it must already be created on the switch. (Range: 1-4094)
- **Voice VLAN Aging Time** – The time after which a port is removed from the Voice VLAN when VoIP traffic is no longer received on the port. (Range: 5-43200 minutes; Default: 1440 minutes).

**Note:** The Voice VLAN ID cannot be modified when the global Auto Detection Status is enabled.



**Web** – Click QoS, VoIP Traffic Setting, Configuration. Enable Auto Detection, specify the Voice VLAN ID, then set the Voice VLAN Aging Time. Click Apply.

VoIP Traffic Configuration	
Auto Detection Status	<input checked="" type="checkbox"/> Enabled
Voice Vlan ID (1-4094)	1234
Voice VLAN Aging Time (5-43200)	1440

Figure 3-140 Configuring VoIP Traffic

**CLI** – This example enables VoIP traffic detection and specifies the Voice VLAN ID as 1234, then sets the VLAN aging time to 3000 seconds.

```

Console(config)#voice vlan 1234                                4-278
Console(config)#voice vlan aging 3000                        4-278
Console(config)#
  
```

## Configuring VoIP Traffic Ports

To configure ports for VoIP traffic, you need to set the mode (Auto or Manual), specify the discovery method to use, and set the traffic priority. You can also enable security filtering to ensure that only VoIP traffic is forwarded on the Voice VLAN.

### Command Attributes

- **Mode** – Specifies if the port will be added to the Voice VLAN when VoIP traffic is detected. (Default: None)
  - **None** – The Voice VLAN feature is disabled on the port. The port will not detect VoIP traffic or be added to the Voice VLAN.
  - **Auto** – The port will be added as a tagged member to the Voice VLAN when VoIP traffic is detected on the port. You must select a method for detecting VoIP traffic, either OUI or 802.1ab (LLDP). When OUI is selected, be sure to configure the MAC address ranges in the Telephony OUI list.
  - **Manual** – The Voice VLAN feature is enabled on the port, but the port must be manually added to the Voice VLAN.
- **Security** – Enables security filtering that discards any non-VoIP packets received on the port that are tagged with the voice VLAN ID. VoIP traffic is identified by source MAC addresses configured in the Telephony OUI list, or through LLDP that discovers VoIP devices attached to the switch. Packets received from non-VoIP sources are dropped. (Default: Disabled)
- **Discovery Protocol** – Selects a method to use for detecting VoIP traffic on the port. (Default: OUI)
  - **OUI** – Traffic from VoIP devices is detected by the Organizationally Unique Identifier (OUI) of the source MAC address. OUI numbers are assigned to manufacturers and form the first three octets of a device MAC address. MAC

### 3 Configuring the Switch

address OUI numbers must be configured in the Telephony OUI list so that the switch recognizes the traffic as being from a VoIP device.

- **802.1ab** – Uses LLDP to discover VoIP devices attached to the port. LLDP checks that the “telephone bit” in the system capability TLV is turned on. See “Link Layer Discovery Protocol” on page 3-212 for more information on LLDP.
- **Priority** – Defines a CoS priority for port traffic on the Voice VLAN. The priority of any received VoIP packet is overwritten with the new priority when the Voice VLAN feature is active for the port.

**Web** – Click QoS, VoIP Traffic Setting, Port Configuration. Set the mode for a VoIP traffic port, select the detection mechanism to use, and specify the VoIP traffic priority. Click Apply.

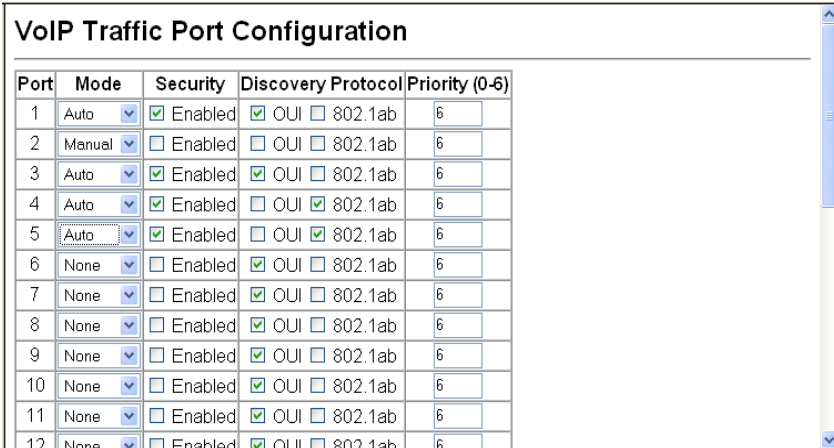

Port	Mode	Security	Discovery Protocol	Priority (0-6)
1	Auto	<input checked="" type="checkbox"/> Enabled	<input checked="" type="checkbox"/> OUI <input type="checkbox"/> 802.1ab	6
2	Manual	<input type="checkbox"/> Enabled	<input type="checkbox"/> OUI <input type="checkbox"/> 802.1ab	6
3	Auto	<input checked="" type="checkbox"/> Enabled	<input checked="" type="checkbox"/> OUI <input type="checkbox"/> 802.1ab	6
4	Auto	<input checked="" type="checkbox"/> Enabled	<input type="checkbox"/> OUI <input checked="" type="checkbox"/> 802.1ab	6
5	Auto	<input checked="" type="checkbox"/> Enabled	<input type="checkbox"/> OUI <input checked="" type="checkbox"/> 802.1ab	6
6	None	<input type="checkbox"/> Enabled	<input checked="" type="checkbox"/> OUI <input type="checkbox"/> 802.1ab	6
7	None	<input type="checkbox"/> Enabled	<input checked="" type="checkbox"/> OUI <input type="checkbox"/> 802.1ab	6
8	None	<input type="checkbox"/> Enabled	<input checked="" type="checkbox"/> OUI <input type="checkbox"/> 802.1ab	6
9	None	<input type="checkbox"/> Enabled	<input checked="" type="checkbox"/> OUI <input type="checkbox"/> 802.1ab	6
10	None	<input type="checkbox"/> Enabled	<input checked="" type="checkbox"/> OUI <input type="checkbox"/> 802.1ab	6
11	None	<input type="checkbox"/> Enabled	<input checked="" type="checkbox"/> OUI <input type="checkbox"/> 802.1ab	6
12	None	<input type="checkbox"/> Enabled	<input checked="" type="checkbox"/> OUI <input type="checkbox"/> 802.1ab	6

Figure 3-141 VoIP Traffic Port Configuration

**CLI** – This example configures VoIP traffic settings for port 2 and displays the current Voice VLAN status.

```

Console(config)#interface ethernet 1/2
Console(config-if)#switchport voice vlan auto                                4-280
Console(config-if)#switchport voice vlan security                          4-281
Console(config-if)#switchport voice vlan rule oui                          4-281
Console(config-if)#switchport voice vlan priority 5                        4-282
Console(config-if)#exit
Console#show voice vlan status                                            4-283
Global Voice VLAN Status
Voice VLAN Status      : Enabled
Voice VLAN ID         : 1234
Voice VLAN aging time : 1440 minutes

Voice VLAN Port Summary
Port      Mode      Security Rule      Priority
-----
Eth 1/ 1  Auto      Enabled OUI                6
Eth 1/ 2  Auto      Enabled OUI                5
Eth 1/ 3  Manual    Enabled OUI                5
Eth 1/ 4  Auto      Enabled OUI                6
Eth 1/ 5  Disabled  Disabled OUI                6
Eth 1/ 6  Disabled  Disabled OUI                6
Eth 1/ 7  Disabled  Disabled OUI                6
Eth 1/ 8  Disabled  Disabled OUI                6
Eth 1/ 9  Disabled  Disabled OUI                6
Eth 1/10  Disabled  Disabled OUI                6
:
```

## Configuring Telephony OUI

VoIP devices attached to the switch can be identified by the manufacturer's Organizational Unique Identifier (OUI) in the source MAC address of received packets. OUI numbers are assigned to manufacturers and form the first three octets of device MAC addresses. The MAC OUI numbers for VoIP equipment can be configured on the switch so that traffic from these devices is recognized as VoIP.

### Command Attributes

- **Telephony OUI** – Specifies a MAC address range to add to the list. Enter the MAC address in format 01-23-45-67-89-AB.
- **Mask** – Identifies a range of MAC addresses. Selecting a mask of FF-FF-FF-00-00-00 identifies all devices with the same OUI (the first three octets). Other masks restrict the MAC address range. Selecting FF-FF-FF-FF-FF-FF specifies a single MAC address. (Default: FF-FF-FF-00-00-00)
- **Description** – User-defined text that identifies the VoIP devices.

### 3 Configuring the Switch

**Web** – Click QoS, VoIP Traffic Setting, OUI Configuration. Enter a MAC address that specifies the OUI for VoIP devices in the network. Select a mask from the pull-down list to define a MAC address range. Enter a description for the devices, then click Add.

**Telephony OUI List**

**Current:**

- 00-23-34-45-56-67, FF-FF-FF-00-00-00, test
- 00-11-22-33-44-55, FF-FF-FF-FF-FF-FF, Chris

<<Add Remove

**New:**

Telephony OUI

Mask

Description

Figure 3-142 Telephony OUI List

**CLI** – This example adds an identifier to the list, then displays the current list

```
Console(config)#voice vlan mac-address 00-e0-bb-00-00-00 mask
ff-ff-ff-00-00-00 description old phones                                4-279
Console(config)#exit
Console#show voice vlan oui                                          4-283
OUIAddress      Mask      Description
00-e0-bb-00-00-00 FF-FF-FF-00-00-00 old phones
00-11-22-33-44-55 FF-FF-FF-00-00-00 new phones
00-98-76-54-32-10 FF-FF-FF-FF-FF-FF Chris' phone
Console#
```

## Multicast Filtering

Multicasting is used to support real-time applications such as videoconferencing or streaming audio. A multicast server does not have to establish a separate connection with each client. It merely broadcasts its service to the network, and any hosts that want to receive the multicast register with their local multicast switch/router. Although this approach reduces the network overhead required by a multicast server, the broadcast traffic must be carefully pruned at every multicast switch/router it passes through to ensure that traffic is only passed on to the hosts which subscribed to this service.

This switch can use Internet Group Management Protocol (IGMP) to filter multicast traffic. IGMP Snooping can be used to passively monitor or “snoop” on exchanges between attached hosts and an IGMP-enabled device, most commonly a multicast router. In this way, the switch can discover the ports that want to join a multicast group, and set its filters accordingly.

If there is no multicast router attached to the local subnet, multicast traffic and query messages may not be received by the switch. In this case (Layer 2) IGMP Query can be used to actively ask the attached hosts if they want to receive a specific multicast service. IGMP Query thereby identifies the ports containing hosts requesting to join the service and sends data out to those ports only. It then propagates the service request up to any neighboring multicast switch/router to ensure that it will continue to receive the multicast service.

The purpose of IP multicast filtering is to optimize a switched network’s performance, so multicast packets will only be forwarded to those ports containing multicast group hosts or multicast routers/switches, instead of flooding traffic to all ports in the subnet (VLAN).

You can also configure a single network-wide multicast VLAN shared by hosts residing in other standard or private VLAN groups, preserving security and data isolation “Multicast VLAN Registration” on page 3-261.

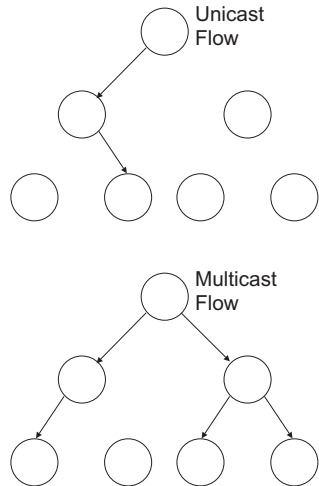

## Layer 2 IGMP (Snooping and Query)

IGMP Snooping and Query – If multicast routing is not supported on other switches in your network, you can use IGMP Snooping and Query (page 3-249) to monitor IGMP service requests passing between multicast clients and servers, and dynamically configure the switch ports which need to forward multicast traffic.

When using IGMPv3 snooping, service requests from IGMP Version 1, 2 or 3 hosts are all forwarded to the upstream router as IGMPv3 reports. The primary enhancement provided by IGMPv3 snooping is in keeping track of information about the specific multicast sources which downstream IGMPv3 hosts have requested or refused. The switch maintains information about both multicast groups and channels, where a group indicates a multicast flow for which the hosts have not requested a specific source (the only option for IGMPv1 and v2 hosts unless statically configured on the switch), and a channel indicates a flow for which the hosts have requested service from a specific source.

Only IGMPv3 hosts can request service from a specific multicast source. When downstream hosts request service from a specific source for a multicast service, these sources are all placed in the Include list, and traffic is forwarded to the hosts from each of these sources. IGMPv3 hosts may also request that service be forwarded from all sources except for those specified. In this case, traffic is filtered from sources in the Exclude list, and forwarded from all other available sources.

- Notes:**
1. When the switch is configured to use IGMPv3 snooping, the snooping version may be downgraded to version 2 or version 1, depending on the version of the IGMP query packets detected on each VLAN.
  2. IGMP snooping will not function unless a multicast router port is enabled on the switch. This can be accomplished in one of two ways. A static router port can be manually configured (see “Specifying Static Interfaces for a Multicast Router” on page 3-253). Using this method, the router port is never timed out, and will continue to function until explicitly removed. The other method relies on the switch to dynamically create multicast routing ports whenever multicast routing protocol packets or IGMP query packets are detected on a port.
  3. A maximum of up to 255 multicast entries can be maintained for IGMP snooping, and 255 entries for Multicast Routing, when both of these features are enabled. If the table’s capacity is exceeded, the IGMPv3 snooping will not support multicast source filtering, but will forward multicast traffic from all relevant sources to the requesting hosts.

Static IGMP Router Interface – If IGMP snooping cannot locate the IGMP querier, you can manually designate a known IGMP querier (i.e., a multicast router/switch) connected over the network to an interface on your switch (page 3-253). This interface will then join all the current multicast groups supported by the attached router/switch to ensure that multicast traffic is passed to all appropriate interfaces within the switch.

Static IGMP Host Interface – For multicast applications that you need to control more carefully, you can manually assign a multicast service to specific interfaces on the switch (page 3-255).

## Configuring IGMP Snooping and Query Parameters

You can configure the switch to forward multicast traffic intelligently. Based on the IGMP query and report messages, the switch forwards traffic only to the ports that request multicast traffic. This prevents the switch from broadcasting the traffic to all ports and possibly disrupting network performance.

### Command Usage

- **IGMP Snooping** – This switch can passively snoop on IGMP Query and Report packets transferred between IP multicast routers/switches and IP multicast host groups to identify the IP multicast group members. It simply monitors the IGMP packets passing through it, picks out the group registration information, and configures the multicast filters accordingly.

**Note:** Unknown multicast traffic is flooded to all ports in the VLAN for several seconds when first received. If a multicast router port exists on the VLAN, the traffic will be filtered by subjecting it to IGMP snooping. If no router port exists on the VLAN or the multicast filtering table is already full, the switch will continue flooding the traffic into the VLAN.

- **IGMP Querier** – A router, or multicast-enabled switch, can periodically ask their hosts if they want to receive multicast traffic. If there is more than one router/switch on the LAN performing IP multicasting, one of these devices is elected “querier” and assumes the role of querying the LAN for group members. It then propagates the service requests on to any upstream multicast switch/router to ensure that it will continue to receive the multicast service.

**Note:** Multicast routers use this information, along with a multicast routing protocol such as DVMRP or PIM, to support IP multicasting across the Internet.

### Command Attributes

- **IGMP Status** — When enabled, the switch will monitor network traffic to determine which hosts want to receive multicast traffic. This is also referred to as IGMP Snooping. (Default: Enabled)
- **Act as IGMP Querier** — When enabled, the switch can serve as the Querier, which is responsible for asking hosts if they want to receive multicast traffic. This feature is not supported for IGMPv3 snooping. (Default: Disabled)
- **IGMP Query Count** — Sets the maximum number of queries issued for which there has been no response before the switch takes action to drop a client from the multicast group. (Range: 2-10; Default: 2)
- **IGMP Query Interval** — Sets the frequency at which the switch sends IGMP host-query messages. (Range: 60-125 seconds; Default: 125)

### 3 Configuring the Switch

- **IGMP Report Delay** — Sets the time between receiving an IGMP Report for an IP multicast address on a port before the switch sends an IGMP Query out of that port and removes the entry from its list. (Range: 5-25 seconds; Default: 10)
- **IGMP Query Timeout** — The time the switch waits after the previous querier stops before it considers the router port (i.e., the interface which had been receiving query packets) to have expired. (Range: 300-500 seconds; Default: 300)
- **IGMP Version** — Sets the protocol version for compatibility with other devices on the network. (Range: 1-3; Default: 2)

**Notes:**

1. All systems on the subnet must support the same version.
2. Some attributes are only enabled for IGMPv2 and/or v3, including Act as IGMP Querier, IGMP Report Delay and IGMP Query Timeout.

**Web** – Click IGMP Snooping, IGMP Configuration. Adjust the IGMP settings as required, and then click Apply. (The default settings are shown below.)

IGMP Configuration	
IGMP Status	<input checked="" type="checkbox"/> Enabled
Act as IGMP Querier	<input type="checkbox"/> Enabled
IGMP Query Count (2-10)	2
IGMP Query Interval (60-125)	125 seconds
IGMP Report Delay (5-25)	10 seconds
IGMP Query Timeout (300-500)	300 seconds
IGMP Version (1,2,3)	2

Figure 3-143 IGMP Configuration



**CLI** – This example modifies the settings for multicast filtering, and then displays the current status.

```

Console(config)#ip igmp snooping                               4-323
Console(config)#ip igmp snooping querier                     4-327
Console(config)#ip igmp snooping query-count 10              4-328
Console(config)#ip igmp snooping query-interval 100          4-328
Console(config)#ip igmp snooping query-max-response-time 20  4-329
Console(config)#ip igmp snooping router-port-expire-time 300 4-330
Console(config)#ip igmp snooping version 2                   4-324
Console(config)#exit
Console#show ip igmp snooping                                 4-324
Service status:      Enabled
Querier status:      Enabled
Leave proxy status:   Disabled
Query count:         10
Query interval:      100 sec
Query max response time: 20 sec
Router port expire time: 300 sec
Immediate Leave Processing: Disabled on all VLAN
IGMP snooping version: Version 2
Console#

```

### Enabling IGMP Immediate Leave

The switch can be configured to immediately delete a member port of a multicast service if a leave packet is received at that port and the immediate-leave function is enabled for the parent VLAN. This allows the switch to remove a port from the multicast forwarding table without first having to send an IGMP group-specific query to that interface.

#### Command Usage

- If immediate leave is *not* used, a multicast router (or querier) will send a group-specific query message when an IGMPv2/v3 group leave message is received. The router/querier stops forwarding traffic for that group only if no host replies to the query within the specified timeout period. Note that the timeout period is determined by the IGMP Query Report Delay (see “Configuring IGMP Snooping and Query Parameters” on page 3-249).
- If immediate leave is enabled, the switch assumes that only one host is connected to the interface. Therefore, immediate leave should only be enabled on an interface if it is connected to only one IGMP-enabled device, either a service host or a neighbor running IGMP snooping.
- Immediate leave is only effective if IGMP snooping is enabled, and IGMPv2 or IGMPv3 snooping is used.
- Immediate leave does not apply to a port if the switch has learned that a multicast router is attached to it.
- Immediate leave can improve bandwidth usage for a network which frequently experiences many IGMP host add and leave requests.

### 3 Configuring the Switch

#### Command Attributes

- **VLAN ID** – VLAN Identifier. (Range: 1-4094).
- **Immediate Leave** – Sets the status for immediate leave on the specified VLAN. (Default: Disabled)

**Web** – Click IGMP Snooping, IGMP Immediate Leave. Select the VLAN interface to configure, set the status for immediate leave, and click Apply.



**IGMP Immediate Leave**

VLAN ID: 1

Immediate Leave  Enabled

Figure 3-144 IGMP Immediate Leave

**CLI** – This example enables IGMP immediate leave for VLAN 1 and then displays the current IGMP snooping status.

```
Console(config)#interface vlan 1
Console(config-if)#ip igmp snooping immediate-leave          4-325
Console(config-if)#end
Console#show ip igmp snooping                                4-324
  Service Status:           Enabled
  Querier Status:           Disabled
  Leave proxy status:       Enabled
  Query Count:              2
  Query Interval:           125 sec
  Query Max Response Time:  10 sec
  Router Port Expire Time:  300 sec
  Immediate Leave Processing: Enabled on VLAN      1,
  IGMP Snooping Version:    Version 2
Console#
```

#### Displaying Interfaces Attached to a Multicast Router

Multicast routers that are attached to ports on the switch use information obtained from IGMP, along with a multicast routing protocol such as DVMRP or PIM, to support IP multicasting across the Internet. These routers may be dynamically discovered by the switch or statically assigned to an interface on the switch.

You can use the Multicast Router Port Information page to display the ports on this switch attached to a neighboring multicast router/switch for each VLAN ID.

#### Command Attributes

- **VLAN ID** – ID of configured VLAN (1-4094).
- **Multicast Router List** – Multicast routers dynamically discovered by this switch or those that are statically assigned to an interface on this switch.

**Web** – Click IGMP Snooping, Multicast Router Port Information. Select the required VLAN ID from the scroll-down list to display the associated multicast routers.

**Figure 3-145** Displaying Multicast Router Port Information

**CLI** – This example shows that Port 11 has been statically configured as a port attached to a multicast router.

```

Console#show ip igmp snooping mrouter vlan 1                               4-331
  VLAN M'cast Router Port Type
  -----
    1           Eth 1/11 Static
Console#

```

### Specifying Static Interfaces for a Multicast Router

Depending on your network connections, IGMP snooping may not always be able to locate the IGMP querier. Therefore, if the IGMP querier is a known multicast router/switch connected over the network to an interface (port or trunk) on your switch, you can manually configure the interface (and a specified VLAN) to join all the current multicast groups supported by the attached router. This can ensure that multicast traffic is passed to all the appropriate interfaces within the switch.

#### Command Attributes

- **Interface** – Activates the Port or Trunk scroll down list.
- **VLAN ID** – Selects the VLAN to propagate all multicast traffic coming from the attached multicast router.
- **Port or Trunk** – Specifies the interface attached to a multicast router.

### 3 Configuring the Switch

**Web** – Click IGMP Snooping, Static Multicast Router Port Configuration. Specify the interfaces attached to a multicast router, indicate the VLAN which will forward all the corresponding multicast traffic, and then click Add. After you have finished adding interfaces to the list, click Apply.

Current:		New:	
Vlan1, Unit1 Port1		Interface	Port
<<Add		VLAN ID	1
Remove		Port	1
		Trunk	

Figure 3-146 Static Multicast Router Port Configuration

**CLI** – This example configures port 1 as a multicast router port within VLAN 1.

```
Console(config)#ip igmp snooping vlan 1 mrouter ethernet 1/1      4-331
Console(config)#exit
Console#show ip igmp snooping mrouter vlan 1                      4-331
  VLAN M'cast Router Port Type
  -----
    1           Eth 1/1  Static
Console#
```

### Displaying Port Members of Multicast Services

You can display the port members associated with a specified VLAN and multicast service.

#### Command Attributes

- **VLAN ID** – Selects the VLAN for which to display port members. (Range: 1-4094)
- **Multicast IP Address** – The IP address for a specific multicast service.
- **Multicast Group Port List** – Shows the interfaces that have already been assigned to the selected VLAN to propagate a specific multicast service.

**Web** – Click IGMP Snooping, IP Multicast Registration Table. Select a VLAN ID and the IP address for a multicast service from the scroll-down lists. The switch will display all the interfaces that are propagating this multicast service.

### IP Multicast Registration Table

---

VLAN ID:

Multicast IP Address:

Multicast Group Port List:

Unit1	Port1	User

Figure 3-147 IP Multicast Registration Table

**CLI** – This example displays all the known multicast services supported on VLAN 1, along with the ports propagating the corresponding services. The Type field shows if this entry was learned dynamically or was statically configured.

```

Console#show bridge 1 multicast vlan 1
VLAN M'cast IP addr. Member ports Type
-----
  1      224.1.1.12      Eth1/12   USER
  1      224.1.1.2.3      Eth1/12   IGMP
Console#
  
```

4-326

## Assigning Ports to Multicast Services

Multicast filtering can be dynamically configured using IGMP Snooping and IGMP Query messages as described in “Configuring IGMP snooping and Query Parameters” on page 3-133. For certain applications that require tighter control, you may need to statically configure a multicast service on the switch. First add all the ports attached to participating hosts to a common VLAN, and then assign the multicast service to that VLAN group.

### Command Usage

- Static multicast addresses are never aged out.
- When a multicast address is assigned to an interface in a specific VLAN, the corresponding traffic can only be forwarded to ports within that VLAN.

### Command Attributes

- **Interface** – Activates the Port or Trunk scroll down list.
- **VLAN ID** – Selects the VLAN to propagate all multicast traffic coming from the attached multicast router/switch. (Range: 1-4094)

### 3 Configuring the Switch

- **Multicast IP** – The IP address for a specific multicast service
- **Port or Trunk** – Specifies the interface attached to a multicast router/switch.

**Web** – Click IGMP Snooping, IGMP Member Port Table. Specify the interface attached to a multicast service (via an IGMP-enabled switch or multicast router), indicate the VLAN that will propagate the multicast service, specify the multicast IP address, and click Add. After you have completed adding ports to the member list, click Apply.

Figure 3-148 IGMP Member Port Table

**CLI** – This example assigns a multicast address to VLAN 1, and then displays all the known multicast services supported on VLAN 1.

```
Console(config)#ip igmp snooping vlan 1 static 224.1.1.12          4-323
 ethernet 1/12
Console(config)#exit
Console#show mac-address-table multicast vlan 1                   4-326
VLAN M'cast IP addr. Member ports Type
-----
 1      224.1.1.12      Eth1/12  USER
 1      224.1.2.3       Eth1/12  IGMP
Console#
```

## IGMP Filtering and Throttling

In certain switch applications, the administrator may want to control the multicast services that are available to end users. For example, an IP/TV service based on a specific subscription plan. The IGMP filtering feature fulfills this requirement by restricting access to specified multicast services on a switch port, and IGMP throttling limits the number of simultaneous multicast groups a port can join.

IGMP filtering enables you to assign a profile to a switch port that specifies multicast groups that are permitted or denied on the port. An IGMP filter profile can contain one or more, or a range of multicast addresses; but only one profile can be assigned to a port. When enabled, IGMP join reports received on the port are checked against the filter profile. If a requested multicast group is permitted, the IGMP join report is forwarded as normal. If a requested multicast group is denied, the IGMP join report is dropped.

IGMP throttling sets a maximum number of multicast groups that a port can join at the same time. When the maximum number of groups is reached on a port, the switch can take one of two actions; either “deny” or “replace”. If the action is set to deny, any new IGMP join reports will be dropped. If the action is set to replace, the switch randomly removes an existing group and replaces it with the new multicast group.

**Note:** IGMP filtering and throttling only applies to dynamically learned multicast groups. It does not apply to statically configured groups.

### Enabling IGMP Filtering

To implement IGMP filtering on the switch, you must first enable the feature globally and create IGMP profile numbers.

#### Command Attributes

- **IGMP Filter** – Enables IGMP filtering and throttling globally for the switch. (Default: Disabled)
- **IGMP Profile** – Creates IGMP profile numbers. (Range: 1-4294967295)

**Web** – Click IGMP Snooping, IGMP Filter Configuration. Create a profile group by entering a number in the text box and clicking Add. Enable the IGMP filter status, then click Apply.

## IGMP Filter Status

---

IGMP Filter  Enabled

## IGMP Profile Configuration

---

**Current:**

25

**New:**

<< Add

IGMP Profile  
{1-4294967295}

Remove

Figure 3-149 Enabling IGMP Filtering and Throttling

### 3 Configuring the Switch

**CLI** – This example enables IGMP filtering and creates a profile number. It then displays the current status and the existing profile numbers.

```
Console(config)#ip igmp filter 4-333
Console(config)#ip igmp profile 19 4-333
Console(config)#end
Console#show ip igmp profile 4-338
IGMP Profile 19
IGMP Profile 25
Console#
```

#### Configuring IGMP Filter Profiles

When you have created an IGMP profile number, you can then configure the multicast groups to filter and set the access mode.

#### Command Usage

- Each profile has only one access mode; either permit or deny.
- When the access mode is set to permit, IGMP join reports are processed when a multicast group falls within the controlled range. When the access mode is set to deny, IGMP join reports are only processed when the multicast group is not in the controlled range.

#### Command Attributes

- **Profile ID** – Selects an existing profile number to configure. After selecting an ID number, click the Query button to display the current configuration.
- **Access Mode** – Sets the access mode of the profile; either permit or deny. (Default: Deny)
- **New Multicast Address Range List** – Specifies multicast groups to include in the profile. Specify a multicast group range by entering a start and end IP address. Specify a single multicast group by entering the same IP address for the start and end of the range. Click the Add button to add a range to the current list.
- **Current Multicast Address Range List** – Lists multicast groups currently included in the profile. Select an entry and click the Remove button to delete it from the list.



**Web** – Click IGMP Snooping, IGMP Filter Profile Configuration. Select the profile number you want to configure; then click Query to display the current settings. Specify the access mode for the profile and then add multicast groups to the profile list. Click Apply.

Figure 3-150 IGMP Profile Configuration

**CLI** – This example configures profile number 19 by setting the access mode to “permit” and then specifying a range of multicast groups that a user can join. The current profile configuration is then displayed.

```

Console(config)# ip igmp profile 19                               4-333
Console(config-igmp-profile)#permit                             4-334
Console(config-igmp-profile)#range 239.1.2.3                   4-334
Console(config-igmp-profile)#range 239.2.3.1 239.2.3.200
Console(config-igmp-profile)#end
Console#show ip igmp profile 19                                  4-338
IGMP Profile 19
  permit
  range 239.1.2.3 239.1.2.3
  range 239.2.3.1 239.2.3.200
Console#

```

## Configuring IGMP Filtering and Throttling for Interfaces

Once you have configured IGMP profiles, you can assign them to interfaces on the switch. Also you can set the IGMP throttling number to limit the number of multicast groups an interface can join at the same time.

### Command Usage

- Only one profile can be assigned to an interface.
- An IGMP profile or throttling setting can also be applied to a trunk interface. When ports are configured as trunk members, the trunk uses the settings applied to the first port member in the trunk.

### 3 Configuring the Switch

- IGMP throttling sets a maximum number of multicast groups that a port can join at the same time. When the maximum number of groups is reached on a port, the switch can take one of two actions; either “deny” or “replace”. If the action is set to deny, any new IGMP join reports will be dropped. If the action is set to replace, the switch randomly removes an existing group and replaces it with the new multicast group.

#### Command Attributes

- **Profile** – Selects an existing profile number to assign to an interface.
- **Max Multicast Groups** – Sets the maximum number of multicast groups an interface can join at the same time. (Range: 0-255; Default: 255)
- **Current Multicast Groups** – Displays the current multicast groups the interface has joined.
- **Throttling Action Mode** – Sets the action to take when the maximum number of multicast groups for the interface has been exceeded. (Default: Deny)
  - **deny** - The new multicast group join report is dropped.
  - **replace** - The new multicast group replaces an existing group.
- **Throttling Status** – Indicates if the throttling action has been implemented on the interface. (Options: True or False)
- **Trunk** – Indicates if a port is a trunk member.

**Web** – Click IGMP Snooping, IGMP Filter/Throttling Port Configuration or IGMP Filter/Throttling Trunk Configuration. Select a profile to assign to an interface, then set the throttling number and action. Click Apply.

IGMP Filter and Throttling Port Configuration						
Port	Profile	Max Multicast Groups (0-256)	Current Multicast Groups	Throttling Action Mode	Throttling Status	Trunk
1	19	64	0	deny	True	
2	19	256	0	deny	False	
3	19	256	0	deny	False	
4	19	256	0	deny	False	
5	19	256	0	deny	False	
6	19	256	0	deny	False	
7	19	256	0	deny	False	
8	19	256	0	deny	False	
9	19	256	0	deny	False	
10	19	256	0	deny	False	
11	19	256	0	deny	False	
12	19	256	0	deny	False	

Figure 3-151 IGMP Filter and Throttling Port Configuration

**CLI** – This example assigns IGMP profile number 19 to port 1, and then sets the throttling number and action. The current IGMP filtering and throttling settings for the interface are then displayed.

```
Console(config)#interface ethernet 1/1 4-187
Console(config-if)#ip igmp filter 19 4-335
Console(config-if)#ip igmp max-groups 64 4-336
Console(config-if)#ip igmp max-groups action deny 4-336
Console(config-if)#end
Console#show ip igmp filter interface ethernet 1/1 4-337
Information of Eth 1/1
IGMP Profile 19
  permit
  range 239.1.2.3 239.1.2.3
  range 239.2.3.1 239.2.3.200
Console#show ip igmp throttle interface ethernet 1/1 4-338
Information of Eth 1/1
  status : TRUE
  action : deny
  max multicast groups : 64
  current multicast groups: 0
Console#
```

## Multicast VLAN Registration

Multicast VLAN Registration (MVR) is a protocol that controls access to a single network-wide VLAN most commonly used for transmitting multicast traffic (such as television channels or video-on-demand) across a service provider's network. Any multicast traffic entering an MVR VLAN is sent to all attached subscribers. This protocol can significantly reduce the processing overhead required to dynamically monitor and establish the distribution tree for a normal multicast VLAN. This makes it possible to support common multicast services over a wide part of the network without having to use any multicast routing protocol.

MVR maintains the user isolation and data security provided by VLAN segregation by passing only multicast traffic into other VLANs to which the subscribers belong. Even though common multicast streams are passed onto different VLAN groups from the MVR VLAN, users in different IEEE 802.1Q or private VLANs cannot exchange any information (except through upper-level routing services).

### 3 Configuring the Switch

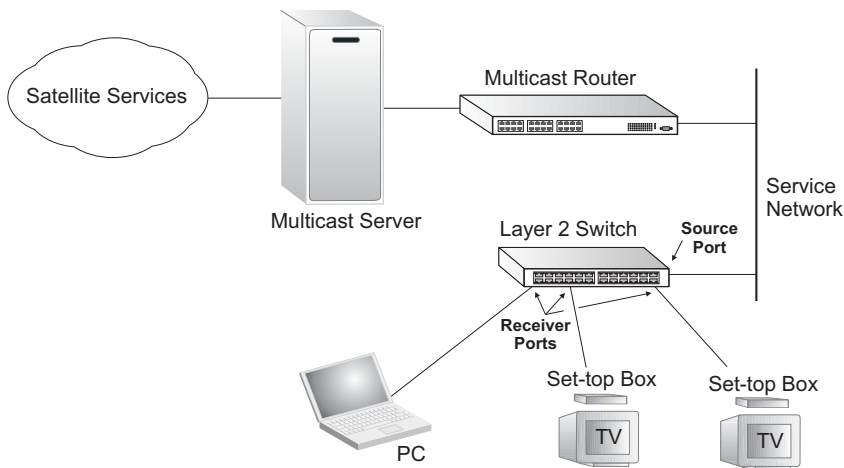

#### *General Configuration Guidelines for MVR*

1. Enable MVR globally on the switch, select the MVR VLAN, and add the multicast groups that will stream traffic to attached hosts (see “Configuring Global MVR Settings” on page 3-262).
2. Set the interfaces that will join the MVR as source ports or receiver ports (see “Configuring MVR Interface Status” on page 3-266).
3. Enable IGMP Snooping to allow a subscriber to dynamically join or leave an MVR group (see “Configuring IGMP Snooping and Query Parameters” on page 3-249). Note that only IGMP version 2 or 3 hosts can issue multicast join or leave messages.
4. For multicast streams that will run for a long term and be associated with a stable set of hosts, you can statically bind the multicast group to the participating interfaces (see “Assigning Static Multicast Groups to Interfaces” on page 3-267).

## **Configuring Global MVR Settings**

The global settings for Multicast VLAN Registration (MVR) include enabling or disabling MVR for the switch, selecting the VLAN that will serve as the sole channel for common multicast streams supported by the service provider, and assigning the multicast group address for each of these services to the MVR VLAN.

### **Command Usage**

IGMP snooping and MVR share a maximum number of 255 groups. Any multicast streams received in excess of this limitation will be flooded to all ports in the associated VLAN.

### Command Attributes

- **MVR Status** – When MVR is enabled on the switch, any multicast data associated with an MVR group is sent from all designated source ports, and to all receiver ports that have registered to receive data from that multicast group. (Default: Disabled)
- **MVR Running Status** – Indicates whether or not all necessary conditions in the MVR environment are satisfied. (Running status is true as long as MVR Status is enabled, and the specified MVR VLAN exists.)
- **MVR VLAN** – Identifier of the VLAN that serves as the channel for streaming multicast services using MVR. MVR source ports should be configured as members of the MVR VLAN (see “Adding Static Members to VLANs (VLAN Index)” on page 3-191), but MVR receiver ports should not be manually configured as members of this VLAN. (Range: 1-4094; Default: 1)
- **MVR Group IP** – IP address for an MVR multicast group. (Range: 224.0.1.0 - 239.255.255.255; Default: no groups are assigned to the MVR VLAN)  
The IP address range of 224.0.0.0 to 239.255.255.255 is used for multicast streams. MVR group addresses cannot fall within the reserved IP multicast address range of 224.0.0.x.
- **Count** – The number of contiguous MVR group addresses. (Range: 1-255; Default: 0)

**Web** – Click MVR, Configuration. Enable MVR globally on the switch, select the MVR VLAN, add the multicast groups that will stream traffic to attached hosts, and then click Apply.

### MVR Configuration

---

MVR Status	<input checked="" type="checkbox"/> Enabled
MVR Running Status	False
MVR VLAN	1 <span style="font-size: small;">▼</span>

---

**MVR Group IP List:**

<b>Current:</b>		<b>New:</b>	
(none)	<input type="button" value=" &lt;&lt; Add"/> <input type="button" value=" Remove"/>	MVR Group IP	228.1.23.1
		Count	10

Figure 3-152 MVR Global Configuration

### 3 Configuring the Switch

**CLI** – This example first enables IGMP snooping, enables MVR globally, and then configures a range of MVR group addresses.

```
Console(config)#ip igmp snooping 4-323
Console(config)#mvr 4-339
Console(config)#mvr group 228.1.23.1 10 4-339
Console(config)#
```

## Displaying MVR Interface Status

You can display information about the interfaces attached to the MVR VLAN.

### Field Attributes

- **Type** – Shows the MVR port type.
- **Oper Status** – Shows the link status.
- **MVR Status** – Shows the MVR status. MVR status for source ports is “ACTIVE” if MVR is globally enabled on the switch. MVR status for receiver ports is “ACTIVE” only if there are subscribers receiving multicast traffic from one of the MVR groups, or a multicast group has been statically assigned to an interface.
- **Immediate Leave** – Shows if immediate leave is enabled or disabled.
- **Trunk Member**<sup>21</sup> – Shows if port is a trunk member.

**Web** – Click MVR, Port or Trunk Information.

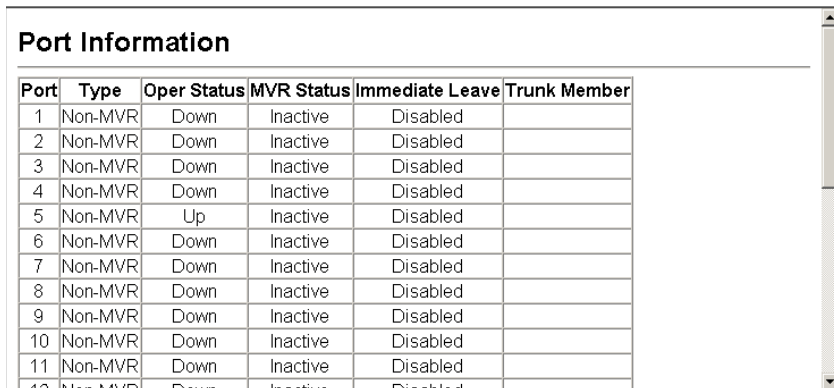

Port	Type	Oper Status	MVR Status	Immediate Leave	Trunk Member
1	Non-MVR	Down	Inactive	Disabled	
2	Non-MVR	Down	Inactive	Disabled	
3	Non-MVR	Down	Inactive	Disabled	
4	Non-MVR	Down	Inactive	Disabled	
5	Non-MVR	Up	Inactive	Disabled	
6	Non-MVR	Down	Inactive	Disabled	
7	Non-MVR	Down	Inactive	Disabled	
8	Non-MVR	Down	Inactive	Disabled	
9	Non-MVR	Down	Inactive	Disabled	
10	Non-MVR	Down	Inactive	Disabled	
11	Non-MVR	Down	Inactive	Disabled	
12	Non-MVR	Down	Inactive	Disabled	
13	Non-MVR	Down	Inactive	Disabled	

Figure 3-153 MVR Port Information

**CLI** – This example shows information about interfaces attached to the MVR VLAN.

```
Console#show mvr interface 4-342
Port      Type      Status      Immediate Leave
-----
eth1/1    SOURCE    ACTIVE/UP    Disable
eth1/2    RECEIVER  ACTIVE/UP    Disable
Console#
```

21. Port Information only.

## Displaying Port Members of Multicast Groups

You can display the multicast groups assigned to the MVR VLAN either through IGMP snooping or static configuration.

### Field Attributes

- **Group IP** – Multicast groups assigned to the MVR VLAN.
- **Group Port List** – Shows the interfaces with subscribers for multicast services provided through the MVR VLAN.

**Web** – Click MVR, Group IP Information.

### MVR Group IP Table

---

Group IP:

Group Port List:

Unit 1, Port 1

Unit 1, Port 2

Figure 3-154 MVR Group IP Information

**CLI** – This example following shows information about the interfaces associated with multicast groups assigned to the MVR VLAN.

```

Console#show mvr interface 4-342
MVR Group IP      Status  Members
-----
225.0.0.1         ACTIVE  eth1/1(d), eth1/2(s)
225.0.0.2         INACTIVE None
225.0.0.3         INACTIVE None
225.0.0.4         INACTIVE None
225.0.0.5         INACTIVE None
225.0.0.6         INACTIVE None
225.0.0.7         INACTIVE None
225.0.0.8         INACTIVE None
225.0.0.9         INACTIVE None
225.0.0.10        INACTIVE None
Console#
  
```

## Configuring MVR Interface Status

Each interface that participates in the MVR VLAN must be configured as an MVR source port or receiver port. If only one subscriber attached to an interface is receiving multicast services, you can enable the immediate leave function.

### Command Usage

- A port which is not configured as an MVR receiver or source port can use IGMP snooping to join or leave multicast groups using the standard rules for multicast filtering.
- Receiver ports can belong to different VLANs, but should not be configured as a member of the MVR VLAN. IGMP snooping can be used to allow a receiver port to dynamically join or leave multicast groups within an MVR VLAN. Multicast groups can also be statically assigned to a receiver port (see “Assigning Static Multicast Groups to Interfaces” on page 3-267). However, if a receiver port is statically configured as a member of an MVR VLAN, its MVR status will be inactive. Also, note that VLAN membership for MVR receiver ports cannot be set to trunk mode (see “Configuring VLAN Behavior for Interfaces” on page 3-194).
- One or more interfaces may be configured as MVR source ports. A source port is able to both receive and send data for multicast groups which it has joined through IGMP snooping or which have been statically assigned (see “Assigning Static Multicast Groups to Interfaces” on page 3-267).
- Immediate leave applies only to receiver ports. When enabled, the receiver port is immediately removed from the multicast group identified in the leave message. When immediate leave is disabled, the switch follows the standard rules by sending a group-specific query to the receiver port and waiting for a response to determine if there are any remaining subscribers for that multicast group before removing the port from the group list.
  - Using immediate leave can speed up leave latency, but should only be enabled on a port attached to one multicast subscriber to avoid disrupting services to other group members attached to the same interface.
  - Immediate leave does not apply to multicast groups which have been statically assigned to a port.

### Command Attributes

- **MVR Type** – The following interface types are supported:
  - Source – An uplink port that can send and receive multicast data for the groups assigned to the MVR VLAN. Note that the source port must be manually configured as a member of the MVR VLAN (see “Adding Static Members to VLANs (VLAN Index)” on page 3-191).
  - Receiver – A subscriber port that can receive multicast data sent through the MVR VLAN. Any port configured as an receiver port will be dynamically added to the MVR VLAN when it forwards an IGMP report or join message from an attached host requesting any of the designated multicast services supported by the MVR VLAN.



- Non-MVR – An interface that does not participate in the MVR VLAN. (This is the default type.)
- **Immediate Leave** – Configures the switch to immediately remove an interface from a multicast stream as soon as it receives a leave message for that group. (This option only applies to an interface configured as an MVR receiver.)
- **Trunk<sup>22</sup>** – Shows if port is a trunk member.

**Web** – Click MVR, Port or Trunk Configuration.

Port	MVR Type	Immediate Leave	Trunk
1	Non-MVR	<input type="checkbox"/> Enabled	
2	Non-MVR	<input type="checkbox"/> Enabled	
3	Non-MVR	<input type="checkbox"/> Enabled	
4	Non-MVR	<input type="checkbox"/> Enabled	
5	Non-MVR	<input type="checkbox"/> Enabled	
6	Non-MVR	<input type="checkbox"/> Enabled	
7	Non-MVR	<input type="checkbox"/> Enabled	
8	Non-MVR	<input type="checkbox"/> Enabled	
9	Non-MVR	<input type="checkbox"/> Enabled	

Figure 3-155 MVR Port Configuration

**CLI** – This example configures an MVR source port and receiver port, and then enables immediate leave on the receiver port.

```

Console(config)#interface ethernet 1/1
Console(config-if)#mvr type source                4-341
Console(config-if)#exit
Console(config)#interface ethernet 1/2
Console(config-if)#mvr type receiver              4-341
Console(config-if)#mvr immediate                  4-341
Console(config-if)#

```

## Assigning Static Multicast Groups to Interfaces

For multicast streams that will run for a long term and be associated with a stable set of hosts, you can statically bind the multicast group to the participating interfaces.

### Command Usage

- Any multicast groups that use the MVR VLAN must be statically assigned to it under the MVR Configuration menu (see “Configuring Global MVR Settings” on page 3-262).

<sup>22</sup>. Port Information only.

### 3 Configuring the Switch

- The IP address range from 224.0.0.0 to 239.255.255.255 is used for multicast streams. MVR group addresses cannot fall within the reserved IP multicast address range of 224.0.0.x.

#### Command Attributes

- **Interface** – Indicates a port or trunk.
- **Member** – Shows the IP addresses for MVR multicast groups which have been statically assigned to the selected interface.
- **Non-Member** – Shows the IP addresses for all MVR multicast groups which have not been statically assigned to the selected interface.

**Web** – Click MVR, Group Member Configuration. Select a port or trunk from the “Interface” field, and click Query to display the assigned multicast groups. Select a multicast address from the displayed lists, and click the Add or Remove button to modify the Member list.

**MVR Static Group Member**

Interface  Port 1  Trunk

Query

Member: (none) << Add Remove >> Non-Member: (none)

Figure 3-156 MVR Group Member Configuration

**CLI** – This example statically assigns a multicast group to a receiver port.

```
Console(config)#interface ethernet 1/2
Console(config-if)#mvr group 228.1.23.1
Console(config-if)#
```

4-341

## Switch Clustering

Switch Clustering is a method of grouping switches together to enable centralized management through a single unit. Switches that support clustering can be grouped together regardless of physical location or switch type, as long as they are connected to the same local network.

### Command Usage

- A switch cluster has a “Commander” unit that is used to manage all other “Member” switches in the cluster. The management station can use both Telnet and the web interface to communicate directly with the Commander through its IP address, while the Commander manages Member switches using cluster “internal” IP addresses.
- Once a switch has been configured to be a cluster Commander, it automatically discovers other cluster-enabled switches in the network. These “Candidate” switches only become cluster Members when manually selected by the administrator through the management station.
- There can be up to 100 candidates and 36 member switches in one cluster.
- A switch can only be a member of one cluster.
- After the Commander and Members have been configured, any switch in the cluster can be managed from the web agent by choosing the desired Member ID from the Cluster drop down menu. To connect to the Member switch from the Commander CLI prompt, use the **rcommand** (see page 4-76) .

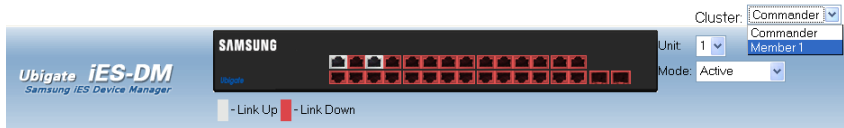

Figure 3-157 Cluster Member Choice

## Configuring General Settings for Clusters

To create a switch cluster, first be sure that clustering is enabled on the switch (the default is enabled), then set the switch as a Cluster Commander. Set a Cluster IP Pool that does not conflict with the network IP subnet. Cluster IP addresses are assigned to switches when they become Members and are used for communication between Member switches and the Commander.

### Command Attributes

- **Cluster Status** – Enables or disables clustering on the switch. (Default: Enabled)
- **Cluster Commander** – Enables or disables the switch as a cluster Commander. (Default: Disabled)
- **Role** – Indicates the current role of the switch in the cluster; either Commander, Member, or Candidate. (Default: Candidate)

### 3 Configuring the Switch

- **Cluster IP Pool** – An “internal” IP address pool that is used to assign IP addresses to Member switches in the cluster. Internal cluster IP addresses are in the form *10.x.x.member-ID*. Only the base IP address of the pool needs to be set since Member IDs can only be between 1 and 36. Note that you cannot change the cluster IP pool when the switch is currently in Commander mode. Commander mode must first be disabled. (Default: 10.254.254.1)
- **Number of Members** – The current number of Member switches in the cluster.
- **Number of Candidates** – The current number of Candidate switches discovered in the network that are available to become Members.

**Web** – Click Cluster, Configuration.

Cluster Configuration	
Cluster Status	<input checked="" type="checkbox"/> Enabled
Cluster Commander	<input checked="" type="checkbox"/> Enabled
Role	Commander
Cluster IP Pool	10.254.254.1
Number of Members	1
Number of Candidates	2

Figure 3-158 Cluster Configuration

**CLI** – This example first enables clustering on the switch, sets the switch as the cluster Commander, and then configures the cluster IP pool.

```
Console(config)#cluster 4-73
Console(config)#cluster commander 4-74
Console(config)#cluster ip-pool 10.2.3.4 4-75
Console(config)#exit
Console#show cluster 4-76
Role: commander
Interval heartbeat: 30
Heartbeat loss count: 3
Number of Members: 0
Number of Candidates: 0
Console#
```

## Configuring Cluster Members

Use the Member Configuration page to add Candidate switches to the cluster as Members.

### Command Attributes

- **Member ID** – Specify a Member ID number for the selected Candidate switch. (Range: 1-36)
- **MAC Address** – Select a discovered switch MAC address from the Candidate Table, or enter a specific MAC address of a known switch.

**Web** – Click Cluster, Member Configuration.

**Figure 3-159 Cluster Member Configuration**

**CLI** – This example creates a new cluster Member by specifying the Candidate switch MAC address and setting a Member ID.

```

Console(config)#cluster member mac-address 00-12-34-56-78-9a id 5      4-75
Console(config)#end
Console#show cluster candidates                                     4-77
Cluster Candidates:
Role           Mac              Description
-----
MEMBER TOBE   00-12-34-56-78-9a
Console#

```

## Displaying Information on Cluster Members

Use the Cluster Member Information page to display information on current cluster Member switches.

### Command Attributes

- **Member ID** – The ID number of the Member switch. (Range: 1-36)
- **Role** – Indicates the current status of the switch in the cluster.
- **IP Address** – The internal cluster IP address assigned to the Member switch.
- **MAC Address** – The MAC address of the Member switch.
- **Description** – The system description string of the Member switch.

### 3 Configuring the Switch

**Web** – Click Cluster, Member Information.

Cluster Member Information				
Member ID	Role	IP Address	MAC Address	Description
1	Active Member	10.254.254.2	00-12-CF-23-49-C0	24/48 L2/L4 IPV4/IPV6 GE Switch

**Figure 3-160 Cluster Member Information**

**CLI** – This example shows information about cluster Member switches.

```
Vty-0#show cluster members 4-77
Cluster Members:
ID: 1
Role: Active member
IP Address: 10.254.254.2
MAC Address: 00-12-cf-23-49-c0
Description: 24/48 L2/L4 IPV4/IPV6 GE Switch
Vty-0#
```

## Displaying Information on Cluster Candidates

Use the Cluster Candidate Information page to display information about discovered switches in the network that are already cluster Members or are available to become cluster Members.

### Command Attributes

- **Role** – Indicates the current status of Candidate switches in the network.
- **MAC Address** – The MAC address of the Candidate switch.
- **Description** – The system description string of the Candidate switch.

**Web** – Click Cluster, Candidate Information.

Cluster Candidate Information		
Clear cluster candidate table. <input type="button" value="Clear"/>		
Role	MAC Address	Description
Active Member	00-12-CF-23-49-C0	24/48 L2/L4 IPV4/IPV6 GE Switch
Candidate	00-12-CF-0B-47-A0	24/48 L2/L4 IPV4/IPV6 GE Switch

**Figure 3-161 Cluster Candidate Information**

**CLI** – This example shows information about cluster Candidate switches.

```
Vty-0#show cluster candidates 4-77
Cluster Candidates:
Role           Mac           Description
-----
ACTIVE MEMBER  00-12-cf-23-49-c0  24/48 L2/L4  IPV4/IPV6  GE Switch
CANDIDATE      00-12-cf-0b-47-a0  24/48 L2/L4  IPV4/IPV6  GE Switch
Vty-0#
```

## UPnP

Universal Plug and Play (UPnP) is a set of protocols that allows devices to connect seamlessly and simplifies the deployment of home and office networks. UPnP achieves this by issuing UPnP device control protocols designed upon open, Internet-based communication standards.

The first step in UPnP networking is discovery. When a device is added to the network, the UPnP discovery protocol allows that device to broadcast its services to control points on the network. Similarly, when a control point is added to the network, the UPnP discovery protocol allows that control point to search for UPnP enabled devices on the network.

Once a control point has discovered a device its next step is to learn more about the device and its capabilities by retrieving the device's description from the URL provided by the device in the discovery message. After a control point has retrieved a description of the device, it can send actions to the device's service. To do this, a control point sends a suitable control message to the control URL for the service (provided in the device description).

When a device is known to the control point, periodic event notification messages are sent. A UPnP description for a service includes a list of actions the service responds to and a list of variables that model the state of the service at run time.

If a device has a URL for presentation, then the control point can retrieve a page from this URL, load the page into a web browser, and depending on the capabilities of the page, allow a user to control the device and/or view device status.

**Note:** UPnP is currently only supported by this switch for Windows Vista, but will be supported for Windows XP in future releases.

### 3 Configuring the Switch

#### Using UPnP under Windows Vista –

To access or manage the switch with the aid of UPnP under Windows Vista, open the Network and Sharing Center, and enable Network Discovery. Then click on the node representing your local network under the Network Sharing Center. An entry for the switch will appear in the list of discovered devices as shown below. Right click on the entry for the switch, and select “View Device webpage” to access the switch’s web management interface, or select “Properties” to display a list of device attributes advertised by the switch through UPnP.

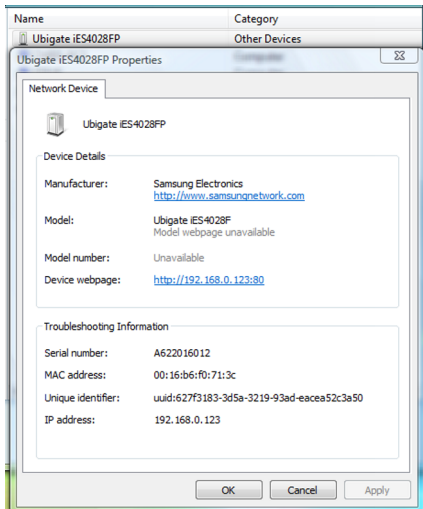

## UPnP Configuration

This page allows you to enable or disable UPnP, and to set time out values.

### Command Attributes

- **UPNP Status** – Enables/disables UPnP on the device.
- **Advertising Duration** – This sets the duration of which a device will advertise its status to the control point. (Range: 60-86400 seconds; Default: 100 seconds)
- **TTL Value** – Sets the time-to-live (TTL) value for UPnP messages transmitted by the device. (Range: 1-255; Default: 4)

**Web** – Click UPNP, Configuration and enter the desired variables.

UPNP Configuration	
UPNP Status	<input type="checkbox"/> Enabled
Advertising Duration (60-86400)	100 seconds
TTL Value(1-255)	4

Figure 3-162 UPnP Configuration



**CLI** – This example enables UPnP, sets the device advertise duration to 200 seconds, the device TTL to 6, and displays information about basic UPnP configuration.

```
Console(config)#upnp device 4-78
Console(config)#upnp device advertise duration 200 4-79
Console(config)#upnp device ttl 6 4-78
Console(config)#end
Console#sh upnp 4-79
UPnP global settings:
  Status: Enabled
  Advertise duration: 200
  TTL: 6
Console#
```

### 3 Configuring the Switch



**This page is intentionally left blank.**

# Chapter 4: Command Line Interface

---

This chapter describes how to use the Command Line Interface (CLI).

## Using the Command Line Interface

### Accessing the CLI

When accessing the management interface for the switch over a direct connection to the server's console port, or via a Telnet connection, the switch can be managed by entering command keywords and parameters at the prompt. Using the switch's command-line interface (CLI) is very similar to entering commands on a UNIX system.

### Console Connection

To access the switch through the console port, perform these steps:

1. At the console prompt, enter the user name and password. (The default user names are "admin" and "guest" with corresponding passwords of "admin" and "guest.") When the administrator user name and password is entered, the CLI displays the "Console#" prompt and enters privileged access mode (i.e., Privileged Exec). But when the guest user name and password is entered, the CLI displays the "Console>" prompt and enters normal access mode (i.e., Normal Exec).
2. Enter the necessary commands to complete your desired tasks.
3. When finished, exit the session with the "quit" or "exit" command.

After connecting to the system through the console port, the login screen displays:

```
User Access Verification
Username: admin
Password:

    CLI session with the iES4028FP is opened.
    To end the CLI session, enter [Exit].

Console#
```

## Telnet Connection

Telnet operates over the IP transport protocol. In this environment, your management station and any network device you want to manage over the network must have a valid IP address. Valid IP addresses consist of four numbers, 0 to 255, separated by periods. Each address consists of a network portion and host portion. For example, the IP address assigned to this switch, 10.1.0.1, with subnet mask 255.255.255.0, consists of a network portion (10.1.0) and a host portion (1).

**Note:** The IP address for this switch is obtained via DHCP by default.

To access the switch through a Telnet session, you must first set the IP address for the Master unit, and set the default gateway if you are managing the switch from a different IP subnet. For example,

```
Console(config)#interface vlan 1
Console(config-if)#ip address 10.1.0.254 255.255.255.0
Console(config-if)#exit
Console(config)#ip default-gateway 10.1.0.254
Console(config)#
```

If your corporate network is connected to another network outside your office or to the Internet, you need to apply for a registered IP address. However, if you are attached to an isolated network, then you can use any IP address that matches the network segment to which you are attached.

After you configure the switch with an IP address, you can open a Telnet session by performing these steps:

1. From the remote host, enter the Telnet command and the IP address of the device you want to access.
2. At the prompt, enter the user name and system password. The CLI will display the “Vty-*n*” prompt for the administrator to show that you are using privileged access mode (i.e., Privileged Exec), or “Vty-*n*>” for the guest to show that you are using normal access mode (i.e., Normal Exec), where *n* indicates the number of the current Telnet session.
3. Enter the necessary commands to complete your desired tasks.
4. When finished, exit the session with the “quit” or “exit” command.

After entering the Telnet command, the login screen displays:

```
Username: admin
Password:

    CLI session with the iES4028FP is opened.
    To end the CLI session, enter [Exit].

Vty-0#
```

**Note:** You can open up to four sessions to the device via Telnet.

## Entering Commands

This section describes how to enter CLI commands.

### Keywords and Arguments

A CLI command is a series of keywords and arguments. Keywords identify a command, and arguments specify configuration parameters. For example, in the command “show interfaces status ethernet 1/5,” **show interfaces** and **status** are keywords, **ethernet** is an argument that specifies the interface type, and **1/5** specifies the unit/port.

You can enter commands as follows:

- To enter a simple command, enter the command keyword.
- To enter multiple commands, enter each command in the required order. For example, to enable Privileged Exec command mode, and display the startup configuration, enter:

```
Console>enable  
Console#show startup-config
```

- To enter commands that require parameters, enter the required parameters after the command keyword. For example, to set a password for the administrator, enter:

```
Console(config)#username admin password 0 smith
```

### Minimum Abbreviation

The CLI will accept a minimum number of characters that uniquely identify a command. For example, the command “configure” can be entered as **con**. If an entry is ambiguous, the system will prompt for further input.

### Command Completion

If you terminate input with a Tab key, the CLI will print the remaining characters of a partial keyword up to the point of ambiguity. In the “logging history” example, typing **log** followed by a tab will result in printing the command up to “**logging**.”

### Getting Help on Commands

You can display a brief description of the help system by entering the **help** command. You can also display command syntax by using the “?” character to list keywords or parameters.

## Showing Commands

If you enter a “?” at the command prompt, the system will display the first level of keywords for the current command class (Normal Exec or Privileged Exec) or configuration class (Global, ACL, Interface, Line or VLAN Database). You can also display a list of valid keywords for a specific command. For example, the command “show ?” displays a list of possible show commands:

```
Console#show ?
access-group      Access groups
access-list       Access lists
accounting        Uses an accounting list with this name
banner           Banner info
bridge-ext        Bridge extension information
calendar          Date and time information
class-map         Displays class maps
cluster          Display cluster
debug            State of each debugging option
dot1q-tunnel      dot1q-tunnel
dot1x            802.1x content
garp             GARP properties
gvrp            GVRP interface information
history          History information
interfaces        Interface information
ip              IP information
lacp            LACP statistics
line            TTY line information
lldp           LLDP
log            Login records
logging        Logging setting
mac           MAC access list
mac-address-table Shows the MAC address table
management   Show management information
map          Maps priority
memory       Memory utilization
mvr         Shows MVR global parameters
network-access Shows the entries of the secure port.
ntp        Network Time Protocol configuration
policy-map Displays policy maps
port      Port characteristics
power     Show power
privilege Shows current privilege level
process   Device process
protocol-vlan Protocol-VLAN information
public-key Public key information
pvlan    Shows the Private VLAN information
queue    Priority queue information
radius-server RADIUS server information
reload   Shows the reload settings
running-config Information on the running configuration
snmp     Simple Network Management Protocol statistics
sntp     Simple Network Time Protocol configuration
spanning-tree Spanning-tree configuration
ssh      Secure shell server connections
startup-config Startup system configuration
system   System information
tacacs-server TACACS server settings
upnp     UPnP settings
users    Information about terminal lines
version  System hardware and software versions
```

```

vlan          Virtual LAN settings
voice         Shows the voice VLAN information
web-auth      Shows web authentication configuration
Console#show

```

The command “**show interfaces ?**” will display the following information:

```

Console#show interfaces ?
counters      Interface counters information
status        Interface status information
switchport    Interface switchport information
Console#show interfaces

```

## Partial Keyword Lookup

If you terminate a partial keyword with a question mark, alternatives that match the initial letters are provided. (Remember not to leave a space between the command and question mark.) For example “**show s?**” shows all the keywords starting with “s.”

```

Console#show s?
snmp          snmp          spanning-tree  ssh          startup-config
system
Console#show s

```

## Negating the Effect of Commands

For many configuration commands you can enter the prefix keyword “**no**” to cancel the effect of a command or reset the configuration to the default value. For example, the **logging** command will log system messages to a host server. To disable logging, specify the **no logging** command. This guide describes the negation effect for all applicable commands.

## Using Command History

The CLI maintains a history of commands that have been entered. You can scroll back through the history of commands by pressing the up arrow key. Any command displayed in the history list can be executed again, or first modified and then executed.

Using the **show history** command displays a longer list of recently executed commands.

## Understanding Command Modes

The command set is divided into Exec and Configuration classes. Exec commands generally display information on system status or clear statistical counters. Configuration commands, on the other hand, modify interface parameters or enable certain switching functions. These classes are further divided into different modes. Available commands depend on the selected mode. You can always enter a question mark “**?**” at the prompt to display a list of the commands available for the

## 4 Command Line Interface

current mode. The command classes and associated modes are displayed in the following table:

**Table 4-1 Command Modes**

Class	Mode	
Exec	Normal Privileged	
Configuration	Global*	Access Control List Class Map Interface Line Multiple Spanning Tree Policy Map Server Group VLAN Database

\* You must be in Privileged Exec mode to access the Global configuration mode.

You must be in Global Configuration mode to access any of the other configuration modes.

### Exec Commands

When you open a new console session on the switch with the user name and password “guest,” the system enters the Normal Exec command mode (or guest mode), displaying the “Console>” command prompt. Only a limited number of the commands are available in this mode. You can access all commands only from the Privileged Exec command mode (or administrator mode). To access Privilege Exec mode, open a new console session with the user name and password “admin.” The system will now display the “Console#” command prompt. You can also enter Privileged Exec mode from within Normal Exec mode, by entering the **enable** command, followed by the privileged level password “super” (page 4-102).

To enter Privileged Exec mode, enter the following user names and passwords:

```
Username: admin
Password: [admin login password]

      CLI session with the iES4028FP is opened.
      To end the CLI session, enter [Exit].

Console#
```

```
Username: guest
Password: [guest login password]

      CLI session with the iES4028FP is opened.
      To end the CLI session, enter [Exit].

Console>enable
Password: [privileged level password]
Console#
```



## Configuration Commands

Configuration commands are privileged level commands used to modify switch settings. These commands modify the running configuration only and are not saved when the switch is rebooted. To store the running configuration in non-volatile storage, use the **copy running-config startup-config** command.

The configuration commands are organized into different modes:

- Global Configuration - These commands modify the system level configuration, and include commands such as **hostname** and **snmp-server community**.
- Access Control List Configuration - These commands are used for packet filtering.
- Class Map Configuration - Creates a DiffServ class map for a specified traffic type.
- Interface Configuration - These commands modify the port configuration such as **speed-duplex** and **negotiation**.
- Line Configuration - These commands modify the console port and Telnet configuration, and include command such as **parity** and **databits**.
- Multiple Spanning Tree Configuration - These commands configure settings for the selected multiple spanning tree instance.
- Policy Map Configuration - Creates a DiffServ policy map for multiple interfaces.
- VLAN Configuration - Includes the command to create VLAN groups.

To enter the Global Configuration mode, enter the command **configure** in Privileged Exec mode. The system prompt will change to "Console(config)#" which gives you access privilege to all Global Configuration commands.

```
Console#configure
Console(config)#
```

To enter the other modes, at the configuration prompt type one of the following commands. Use the **exit** or **end** command to return to the Privileged Exec mode.

**Table 4-2 Configuration Modes**

Mode	Command	Prompt	Page
Line	line {console   vty}	Console(config-line)#	4-40
Access Control List	access-list ip standard access-list ip extended access-list mac	Console(config-std-acl) Console(config-ext-acl) Console(config-mac-acl)	4-175 4-178 4-183
Class Map	class-map	Console(config-cmap)	4-314
Interface	interface {ethernet <i>port</i>   port-channel <i>id</i>   vlan <i>id</i> }	Console(config-if)#	4-187
MSTP	spanning-tree mst-configuration	Console(config-mstp)#	4-232
Policy Map	policy-map	Console(config-pmap)	4-316
Server Group	aaa group server {radius   tacacs+}	Console(config-sg-radius)# Console(config-sg-tacacs+)	4-114
VLAN	vlan database	Console(config-vlan)	4-252

## 4 Command Line Interface

For example, you can use the following commands to enter interface configuration mode, and then return to Privileged Exec mode

```
Console(config)#interface ethernet 1/5
.
.
Console(config-if)#exit
Console(config)#
```

### Command Line Processing

Commands are not case sensitive. You can abbreviate commands and parameters as long as they contain enough letters to differentiate them from any other currently available commands or parameters. You can use the Tab key to complete partial commands, or enter a partial command followed by the “?” character to display a list of possible matches. You can also use the following editing keystrokes for command-line processing:

**Table 4-3 Command Line Processing**

Keystroke	Function
Ctrl-A	Shifts cursor to start of command line.
Ctrl-B	Shifts cursor to the left one character.
Ctrl-C	Terminates the current task and displays the command prompt.
Ctrl-E	Shifts cursor to end of command line.
Ctrl-F	Shifts cursor to the right one character.
Ctrl-K	Deletes all characters from the cursor to the end of the line.
Ctrl-L	Repeats current command line on a new line.
Ctrl-N	Enters the next command line in the history buffer.
Ctrl-P	Enters the last command.
Ctrl-R	Repeats current command line on a new line.
Ctrl-U	Deletes from the cursor to the beginning of the line.
Ctrl-W	Deletes the last word typed.
Esc-B	Moves the cursor back one word.
Esc-D	Deletes from the cursor to the end of the word.
Esc-F	Moves the cursor forward one word.
Delete key or backspace key	Erases a mistake when entering a command.

## Command Groups

The system commands can be broken down into the functional groups shown below.

**Table 4-4 Command Groups**

Command Group	Description	Page
General	Basic commands for entering privileged access mode, restarting the system, or quitting the CLI	4-10
System Management	Display and setting of system information, basic modes of operation, maximum frame size, file management, console port and telnet settings, system logs, SMTP alerts, system clock, switch clustering, and UPnP	4-16
Simple Network Management Protocol	Activates authentication failure traps; configures community access strings, and trap managers; also configures IP address filtering	4-86
Authentication	Configures user names and passwords, logon access using local or remote authentication (including AAA), management access through the web server, Telnet server and Secure Shell; as well as port security, IEEE 802.1X port access control, and restricted access based on specified IP addresses	4-100
General Security Measures	Segregates traffic for clients attached to common data ports; and prevents unauthorized access by configuring valid static or dynamic addresses, web authentication, MAC address authentication, and filtering DHCP requests and replies	4-147
Access Control List	Provides filtering for IP frames (based on address, protocol, or TCP/UDP port number or TCP control code) or non-IP frames (based on MAC address or Ethernet type)	4-175
Interface	Configures the connection parameters for all Ethernet ports, aggregated links, and VLANs	4-187
Link Aggregation	Statically groups multiple ports into a single logical trunk; configures Link Aggregation Control Protocol for port trunks	4-201
Power over Ethernet	Configures power output for connected devices	4-212
Mirror Port	Mirrors data to another port for analysis without affecting the data passing through or the performance of the monitored port	4-218
Rate Limiting	Controls the maximum rate for traffic transmitted or received on a port	4-220
Address Table	Configures the address table for filtering specified addresses, displays current entries, clears the table, or sets the aging time	4-221
Spanning Tree	Configures Spanning Tree settings for the switch	4-225
VLANs	Configures VLAN settings, and defines port membership for VLAN groups; also enables or configures private VLANs, protocol VLANs, and voice VLANs	4-247
Link Layer Discovery Protocol	Configures LLDP settings to enable information discovery about neighbor devices	4-225
Class of Service	Sets port priority for untagged frames, selects strict priority or weighted round robin, relative weight for each priority queue, also sets priority for TCP/UDP traffic types, and DSCP	4-284
Quality of Service	Configures Differentiated Services	4-313

**Table 4-4 Command Groups (Continued)**

Command Group	Description	Page
Multicast Filtering	Configures IGMP multicast filtering, query parameters, specifies ports attached to a multicast router, and enables multicast VLAN registration	4-322
IP Interface	Configures IP address for the switch	4-345

The access mode shown in the following tables is indicated by these abbreviations:

**ACL** (Access Control List Configuration)

**CM** (Class Map Configuration)

**GC** (Global Configuration)

**IC** (Interface Configuration)

**LC** (Line Configuration)

**SG** (Server Group)

**MST** (Multiple Spanning Tree)

**NE** (Normal Exec)

**PE** (Privileged Exec)

**PM** (Policy Map Configuration)

**VC** (VLAN Database Configuration)

## General Commands

**Table 4-5 General Commands**

Command	Function	Mode	Page
enable	Activates privileged mode	NE	4-11
disable	Returns to normal mode from privileged mode	PE	4-11
configure	Activates global configuration mode	PE	4-12
show history	Shows the command history buffer	NE, PE	4-12
reload	Restarts the system	PE	4-13
show reload	Displays the time remaining until a delayed reset will take place	PE	4-14
prompt	Customizes the prompt used in PE and NE mode	GC	4-14
end	Returns to Privileged Exec mode	any config. mode	4-15
exit	Returns to the previous configuration mode, or exits the CLI	any	4-15
quit	Exits a CLI session	NE, PE	4-16
help	Shows how to use help	any	NA
?	Shows options for command completion (context sensitive)	any	NA

## enable

This command activates Privileged Exec mode. In privileged mode, additional commands are available, and certain commands display additional information. See “Understanding Command Modes” on page 4-5.

### Syntax

**enable** [/level]

*level* - Privilege level to log into the device.

The device has two predefined privilege levels: 0: Normal Exec, 15: Privileged Exec. Enter level 15 to access Privileged Exec mode.

### Default Setting

Level 15

### Command Mode

Normal Exec

### Command Usage

- “super” is the default password required to change the command mode from Normal Exec to Privileged Exec. (To set this password, see the **enable password** command on page 4-102.)
- The “#” character is appended to the end of the prompt to indicate that the system is in privileged access mode.

### Example

```
Console>enable
Password: [privileged level password]
Console#
```

### Related Commands

disable (4-11)

enable password (4-102)

## disable

This command returns to Normal Exec mode from privileged mode. In normal access mode, you can only display basic information on the switch's configuration or Ethernet statistics. To gain access to all commands, you must use the privileged mode. See “Understanding Command Modes” on page 4-5.

### Default Setting

None

### Command Mode

Privileged Exec

### Command Usage

The “>” character is appended to the end of the prompt to indicate that the system is in normal access mode.

### Example

```
Console#disable  
Console>
```

### Related Commands

enable (4-11)

### configure

This command activates Global Configuration mode. You must enter this mode to modify any settings on the switch. You must also enter Global Configuration mode prior to enabling some of the other configuration modes, including Interface Configuration, Line Configuration, VLAN Database Configuration, and Multiple Spanning Tree Configuration. See “Understanding Command Modes” on page 4-5.

### Default Setting

None

### Command Mode

Privileged Exec

### Example

```
Console#configure  
Console(config)#
```

### Related Commands

end (4-15)

### show history

This command shows the contents of the command history buffer.

### Default Setting

None

### Command Mode

Normal Exec, Privileged Exec

### Command Usage

The history buffer size is fixed at 10 Execution commands and 10 Configuration commands.

## Example

In this example, the show history command lists the contents of the command history buffer:

```
Console#show history
Execution command history:
 2 config
 1 show history

Configuration command history:
 4 interface vlan 1
 3 exit
 2 interface vlan 1
 1 end

Console#
```

The **!** command repeats commands from the Execution command history buffer when you are in Normal Exec or Privileged Exec Mode, and commands from the Configuration command history buffer when you are in any of the configuration modes. In this example, the **!2** command repeats the second command in the Execution history buffer (**config**).

```
Console#!2
Console#config
Console(config)#
```

## reload

This command restarts the system. You can reboot the system immediately, or you can configure the switch to reset after a specified amount of time. Use the **cancel** keyword to cancel the next configured delayed reset.

### Syntax

**reload** [**in** {**hour** *hours* **minute** *minutes* | **minute** *minutes*} | **cancel**]

*hours* - Specifies the amount of hours to wait, combined with the minutes, before the switch resets. (Range: 0-576; Default: 0)

*minutes* - Specifies the amount of minutes to wait, combined with the hours, before the switch resets. (Range: 1-34560; Default: 0)

**cancel** - Cancels a pending delayed reset.

**Note:** When the system is restarted, it will always run the Power-On Self-Test. It will also retain all configuration information stored in non-volatile memory by the **copy running-config startup-config** command (See “copy” on page 4-35).

### Default Setting

None

### Command Mode

Privileged Exec

### Command Usage

This command resets the entire system. The switch will wait the designated amount of time before resetting. If a delayed reset has already been scheduled, then the newly configured reset will overwrite the original delay configuration. The configured delay time cannot exceed 24 days (576 hours, or 34560 minutes). If no time is specified, then the switch will reboot immediately.

### Example

This example shows how to reset the switch:

```
Console#reload
System will be restarted, continue <y/n>? y
```

### show reload

This command displays the remaining time until a pending delayed reset will take place.

### Syntax

**show reload**

### Default Setting

None

### Command Mode

Privileged Exec

### Example

This example shows how to display the remaining time until a configured delayed reset of the switch will take place:

```
Console#show reload

The switch will be rebooted at Nov 23 22:52:14 2007.
Remaining Time : 0 days, 4 hours, 31 minutes, 46 seconds.

Console#
```

### prompt

This command customizes the CLI prompt. Use the **no** form to restore the default prompt.

### Syntax

**prompt *string***  
**no prompt**

*string* - Any alphanumeric string to use for the CLI prompt. (Maximum length: 255 characters)

### Default Setting

Console



**Command Mode**

Global Configuration

**Example**

```
Console(config)#prompt RD2
RD2(config)#
```

**end**

This command returns to Privileged Exec mode.

**Default Setting**

None

**Command Mode**

Global Configuration, Interface Configuration, Line Configuration, VLAN Database Configuration, and Multiple Spanning Tree Configuration.

**Example**

This example shows how to return to the Privileged Exec mode from the Interface Configuration mode:

```
Console(config-if)#end
Console#
```

**exit**

This command returns to the previous configuration mode or exit the configuration program.

**Default Setting**

None

**Command Mode**

Any

**Example**

This example shows how to return to the Privileged Exec mode from the Global Configuration mode, and then quit the CLI session:

```
Console(config)#exit
Console#exit

Press ENTER to start session
User Access Verification

Username:
```

## quit

This command exits the configuration program.

## Default Setting

None

## Command Mode

Normal Exec, Privileged Exec

## Command Usage

The **quit** and **exit** commands can both exit the configuration program.

## Example

This example shows how to quit a CLI session:

```
Console#quit

Press ENTER to start session

User Access Verification

Username:
```

# System Management Commands

These commands are used to control system logs, passwords, user names, browser configuration options, and display or configure a variety of other system information.

**Table 4-6 System Management Commands**

Command Group	Function	Page
Device Designation	Configures information that uniquely identifies this switch	4-17
Banner Information	Configures administrative contact device identification and location	4-18
System Status	Displays system configuration, active managers, and version information	4-27
Frame Size	Enables support for jumbo frames	4-33
File Management	Manages code image or switch configuration files	4-34
Line	Sets communication parameters for the serial port, including baud rate and console time-out	4-40
Event Logging	Controls logging of error messages	4-49
SMTP Alerts	Configures SMTP email alerts	4-56
Time (System Clock)	Sets the system clock automatically via NTP/SNTP server or manually	4-59
Switch Clustering	Configures management of multiple devices via a single IP address	4-73
UPnP	Sets Universal Plug-and-Play parameters used to advertise the switch	4-77
Debug	Enables CLI debug messages	4-80
User Access	Configures the basic user names and passwords for management access	4-100
IP Filter	Configures IP addresses that are allowed management access	4-145

Table 4-6 System Management Commands (Continued)

Command Group	Function	Page
Web Server	Enables management access via a web browser	4-123
Telnet Server	Enables management access via Telnet	4-126
Secure Shell	Provides secure replacement for Telnet	4-127

## Device Designation Commands

Table 4-7 Device Designation Commands

Command	Function	Mode	Page
prompt	Customizes the prompt used in PE and NE mode	GC	4-14
hostname	Specifies the host name for the switch	GC	4-17
snmp-server contact	Sets the system contact string	GC	4-88
snmp-server location	Sets the system location string	GC	4-89

### hostname

This command specifies or modifies the host name for this device. Use the **no** form to restore the default host name.

#### Syntax

**hostname** *name*

**no hostname**

*name* - The name of this host. (Maximum length: 255 characters)

#### Default Setting

None

#### Command Mode

Global Configuration

#### Example

```
Console(config)#hostname RD#1
Console(config)#
```

## Banner Information Commands

These commands are used to configure and manage administrative information about the switch, its exact data center location, details of the electrical and network circuits that supply the switch, as well as contact information for the network administrator and system manager. This information is only available via the CLI and is automatically displayed before login as soon as a console or telnet connection has been established.

**Table 4-8 Banner Commands**

Command	Function	Mode	Page
banner configure	Configures banner information that is displayed before login	GC	4-18
banner configure company	Configures Company information that is displayed by the banner	GC	4-19
banner configure dc-power-info	Configures DC Power information that is displayed by the banner	GC	4-20
banner configure department	Configures Department information that is displayed by the banner	GC	4-21
banner configure equipment-info	Configures Equipment information that is displayed by the banner	GC	4-21
banner configure equipment-location	Configures Equipment Location information that is displayed by the banner	GC	4-22
banner configure ip-lan	Configures IP and LAN information that is displayed by the banner	GC	4-23
banner configure lp-number	Configures LP Number information that is displayed by the banner	GC	4-23
banner configure manager-info	Configures Manager contact information that is displayed by the banner	GC	4-24
banner configure mux	Configures MUX information that is displayed by the banner	GC	4-25
banner configure note	Configures miscellaneous information displayed by the banner under the Notes heading	GC	4-25
show banner	Displays all banner information	NE, PE	4-26

### banner configure

This command is used to interactively specify administrative information for this device.

#### Syntax

banner configure

#### Default Setting

None

#### Command Mode

Global Configuration

## Command Usage

The administrator can batch-input all details for the switch with one command. When the administrator finishes typing the company name and presses the enter key, the script prompts for the next piece of information, and so on, until all information has been entered. Pressing enter without inputting information at any prompt during the script's operation will leave the field empty. Spaces can be used during script mode because pressing the enter key signifies the end of data input. The delete and left-arrow keys terminate the script. Use of the backspace key during script mode is not supported. If, for example, a mistake is made in the company name, it can be corrected with the **banner configure company** command.

## Example

```
Console(config)#banner configure

Company: Samsung Corporation
Responsible department: R&D Dept
Name and telephone to Contact the management people
Manager1 name: Sr. Network Admin
    phone number: 123-555-1212
Manager2 name: Wile E. Coyote
    phone number: 123-555-1213
Manager3 name: Night-shift Net Admin / Janitor
    phone number: 123-555-1214
The physical location of the equipment.
City and street address: 12 Straight St. Motown, Zimbabwe
Information about this equipment:
Manufacturer: Samsung Networks
ID: 123_unique_id_number
Floor: 2
Row: 7
Rack: 29
Shelf in this rack: 8
Information about DC power supply.
Floor: 2
Row: 7
Rack: 25
Electrical circuit: : ec-177743209-xb
Number of LP:12
Position of the equipment in the MUX:1/23
IP LAN:192.168.1.1
Note: This is a random note about this managed switch and can contain
miscellaneous information.
Console(config)#
```

## banner configure company

This command is used to configure company information displayed in the banner. Use the **no** form to restore the default setting.

## Syntax

**banner configure company** *name*  
**no banner configure company**

*name* - The name of the company. (Maximum length: 32 characters)

## 4 Command Line Interface

### Default Setting

None

### Command Mode

Global Configuration

### Command Usage

Input strings cannot contain spaces. The **banner configure company** command interprets spaces as data input boundaries. The use of underscores ( `_` ) or other unobtrusive non-letter characters is suggested for situations where white space is necessary for clarity.

### Example

```
Console(config)#banner configure company Samsung_Corporation
Console(config)#
```

### banner configure dc-power-info

This command is use to configure DC power information displayed in the banner. Use the **no** form to restore the default setting.

### Syntax

```
banner configure dc-power-info floor floor-id row row-id rack rack-id
electrical-circuit ec-id
no banner configure dc-power-info [floor | row | rack | electrical-circuit]
```

- *floor-id* - The floor number.
- *row-id* - The row number.
- *rack-id* - The rack number.
- *ec-id* - The electrical circuit ID.

Maximum length of each parameter: 32 characters

### Default Setting

None

### Command Mode

Global Configuration

### Command Usage

Input strings cannot contain spaces. The **banner configure dc-power-info** command interprets spaces as data input boundaries. The use of underscores ( `_` ) or other unobtrusive non-letter characters is suggested for situations where white space is necessary for clarity.

### Example

```
Console(config)#banner configure floor 3 row 15 rack 24
  electrical-circuit 48v-id_3.15.24.2
Console(config)#
```

### banner configure department

This command is used to configure the department information displayed in the banner. Use the **no** form to restore the default setting.

#### Syntax

```
banner configure department dept-name
no banner configure company
```

*dept-name* - The name of the department.  
(Maximum length: 32 characters)

#### Default Setting

None

#### Command Mode

Global Configuration

#### Command Usage

Input strings cannot contain spaces. The **banner configure department** command interprets spaces as data input boundaries. The use of underscores ( `_` ) or other unobtrusive non-letter characters is suggested for situations where white space is necessary for clarity.

#### Example

```
Console(config)#banner configure department R&D
Console(config)#
```

### banner configure equipment-info

This command is used to configure the equipment information displayed in the banner. Use the **no** form to restore the default setting.

#### Syntax

```
banner configure equipment-info manufacturer-id mfr-id floor floor-id
row row-id rack rack-id shelf-rack sr-id manufacturer mfr-name
no banner configure equipment-info [floor | manufacturer |
manufacturer-id | rack | row | shelf-rack]
```

- *mfr-id* - The name of the device model number.
- *floor-id* - The floor number.
- *row-id* - The row number.
- *rack-id* - The rack number.
- *sr-id* - The shelf number in the rack.
- *mfr-name* - The name of the device manufacturer.

Maximum length of each parameter: 32 characters

#### Default Setting

None

## 4 Command Line Interface

### Command Mode

Global Configuration

### Command Usage

Input strings cannot contain spaces. The **banner configure equipment-info** command interprets spaces as data input boundaries. The use of underscores ( `_` ) or other unobtrusive non-letter characters is suggested for situations where white space is necessary for clarity.

### Example

```
Console(config)#banner configure equipment-info manufacturer-id
2852Samsung-PoE floor 3 row 10 rack 15 shelf-rack 12 manufacturer
Samsung_Corporation
Console(config)#
```

### banner configure equipment-location

This command is used to configure the equipment location information displayed in the banner. Use the **no** form to restore the default setting.

### Syntax

**banner configure equipment-location** *location*

**no banner configure equipment-location**

*location* - The address location of the device.  
(Maximum length: 32 characters)

### Default Setting

None

### Command Mode

Global Configuration

### Command Usage

Input strings cannot contain spaces. The **banner configure equipment-location** command interprets spaces as data input boundaries. The use of underscores ( `_` ) or other unobtrusive non-letter characters is suggested for situations where white space is necessary for clarity.

### Example

```
Console(config)#banner configure equipment-location
710_Network_Path,_Indianapolis
Console(config)#
```



## banner configure ip-lan

This command is used to configure the device IP address and subnet mask information displayed in the banner. Use the **no** form to restore the default setting.

### Syntax

**banner configure ip-lan** *ip-mask*

**no banner configure ip-lan**

*ip-mask* - The IP address and subnet mask of the device.  
(Maximum length: 32 characters)

### Default Setting

None

### Command Mode

Global Configuration

### Command Usage

Input strings cannot contain spaces. The **banner configure ip-lan** command interprets spaces as data input boundaries. The use of underscores ( `_` ) or other unobtrusive non-letter characters is suggested for situations where white space is necessary for clarity.

### Example

```
Console(config)#banner configure ip-lan 192.168.1.1/255.255.255.0
Console(config)#
```

## banner configure lp-number

This command is used to configure the LP number information displayed in the banner. Use the **no** form to restore the default setting.

### Syntax

**banner configure lp-number** *lp-num*

**no banner configure lp-number**

*lp-num* - The LP number. (Maximum length: 32 characters)

### Default Setting

None

### Command Mode

Global Configuration

### Command Usage

Input strings cannot contain spaces. The **banner configure lp-number** command interprets spaces as data input boundaries. The use of underscores ( `_` ) or other unobtrusive non-letter characters is suggested for situations where white space is necessary for clarity.

### Example

```
Console(config)#banner configure lp-number 12
Console(config)#
```

### banner configure manager-info

This command is used to configure the manager contact information displayed in the banner. Use the **no** form to restore the default setting.

### Syntax

```
banner configure manager-info name mgr1-name
  phone-number mgr1-number [name2 mgr2-name
  phone-number mgr2-number | name3 mgr3-name
  phone-number mgr3-number]
no banner configure manager-info [name1 | name2 | name3]
```

- *mgr1-name* - The name of the first manager.
- *mgr1-number* - The phone number of the first manager.
- *mgr2-name* - The name of the second manager.
- *mgr2-number* - The phone number of the second manager.
- *mgr3-name* - The name of the third manager.
- *mgr3-number* - The phone number of the third manager.

Maximum length of each parameter: 32 characters

### Default Setting

None

### Command Mode

Global Configuration

### Command Usage

Maximum string length for each command attribute is 32 characters. The **banner configure manager-info** command interprets spaces as data input boundaries. The use of underscores ( `_` ) or other unobtrusive non-letter characters is suggested for situations where white space is necessary for clarity.

### Example

```
Console(config)#banner configure manager-info name Albert_Einstein
  phone-number 123-555-1212 name2 Lamar phone-number 123-555-1219
Console(config)#
```

### banner configure mux

This command is used to configure the mux information displayed in the banner. Use the **no** form to restore the default setting.

#### Syntax

**banner configure mux** *muxinfo*

**no banner configure mux**

*muxinfo* - The circuit and PVC to which the switch is connected.  
(Maximum length: 32 characters)

#### Default Setting

None

#### Command Mode

Global Configuration

#### Command Usage

Input strings cannot contain spaces. The **banner configure mux** command interprets spaces as data input boundaries. The use of underscores ( `_` ) or other unobtrusive non-letter characters is suggested for situations where white space is necessary for clarity.

#### Example

```
Console(config)#banner configure mux telco-8734212kx_PVC-1/23
Console(config)#
```

### banner configure note

This command is used to configure the note displayed in the banner. Use the **no** form to restore the default setting.

#### Syntax

**banner configure note** *note-info*

**no banner configure note**

*note-info* - Miscellaneous information that does not fit the other banner categories, or any other information of importance to users of the switch CLI. (Maximum length: 150 characters)

#### Default Setting

None

#### Command Mode

Global Configuration

## 4 Command Line Interface

### Command Usage

Input strings cannot contain spaces. The **banner configure note** command interprets spaces as data input boundaries. The use of underscores ( `_` ) or other unobtrusive non-letter characters is suggested for situations where white space is necessary for clarity.

### Example

```
Console(config)#banner configure note !!!!!ROUTINE_MAINTENANCE_firmware-
upgrade_0100-0500_GMT-0500_20071022!!!!!!_20min_network_impact_expected
Console(config)#
```

### show banner

This command displays all banner information.

### Syntax

**show banner**

### Default Setting

None

### Command Mode

Normal Exec, Privileged Exec

### Example

```
Console#show banner
Samsung_Corporation
WARNING - MONITORED ACTIONS AND ACCESSES
R&D_Dept

Albert_Einstein - 123-555-1212
Wile_E._Coyote - 123-555-9876
Lamar - 123-555-3322

Station's information:
710_Network_Path,Indianapolis

Samsung_Corporation - iES4028FP
Floor / Row / Rack / Sub-Rack
7 / 10 / 15 / 6
DC power supply:
Power Source A: Floor / Row / Rack / Electrical circuit
3 / 15 / 24 / 48V-id_3.15.24.2

Number of LP: 4
Position MUX: telco-9734212kx_PVC-1/23
IP LAN: 216.241.132.3/255.255.255.0
Note:
!!!!ROUTINE_MAINTENANCE_firmware-upgrade_0100--0500_GMT-0500_20071022!!!
!!_20min_network_impact_expected
Console#
```

## System Status Commands

This section describes commands used to display system information.

**Table 4-9 System Status Commands**

Command	Function	Mode	Page
show startup-config	Displays the contents of the configuration file (stored in flash memory) that is used to start up the system	PE	4-27
show running-config	Displays the configuration data currently in use	PE	4-29
show system	Displays system information	NE, PE	4-31
show users	Shows all active console and Telnet sessions, including user name, idle time, and IP address of Telnet clients	NE, PE	4-31
show version	Displays version information for the system	NE, PE	4-32

### show startup-config

This command displays the configuration file stored in non-volatile memory that is used to start up the system.

#### Default Setting

None

#### Command Mode

Privileged Exec

#### Command Usage

- Use this command in conjunction with the **show running-config** command to compare the information in running memory to the information stored in non-volatile memory.
- This command displays settings for key command modes. Each mode group is separated by “!” symbols, and includes the configuration mode command, and corresponding commands. This command displays the following information:
  - Switch’s MAC address
  - SNTP and NTP server settings
  - 802.1Q tunnel settings
  - Power over Ethernet settings
  - Broadcast storm control settings
  - SNMP community strings
  - Users (names and access levels)
  - Event log settings
  - VLAN database (VLAN ID, name and state)
  - VLAN configuration settings for each interface
  - Multiple spanning tree instances (name and interfaces)
  - IP address configured for the switch

## 4 Command Line Interface

- Spanning tree settings
- Interface settings
- Any configured settings for the console port and Telnet

### Example

```
Console#show startup-config
building startup-config, please wait...
!<stackingDB>00</stackingDB>
!<stackingMac>01_00-16-b6-f0-6f-fd_00</stackingMac>
!
phymap 00-16-b6-f0-6f-fd
!
sntp server 0.0.0.0 0.0.0.0 0.0.0.0
!
ntp poll 16
!
no dot1q-tunnel system-tunnel-control
!
power mainpower maximum allocation 180 unit 1
!
snmp-server community public ro
snmp-server community private rw
!
username admin access-level 15
username admin password 7 21232f297a57a5a743894a0e4a801fc3
username guest access-level 0
username guest password 7 084e0343a0486ff05530df6c705c8bb4
enable password level 15 7 1b3231655cebb7a1f783eddf27d254ca
!
vlan database
  vlan 1 name DefaultVlan media ethernet state active
  vlan 4093 media ethernet state active
!
spanning-tree mst configuration
!
interface vlan 1
  ip address dhcp
!
interface ethernet 1/1
  switchport allowed vlan add 1 untagged
  switchport native vlan 1
  switchport allowed vlan add 4093 tagged
:
!
ip name-server auto
!
line console
  silent-time 0
!
line VTY
!
end
!
Console#
```

### Related Commands

show running-config (4-29)

**show running-config**

This command displays the configuration information currently in use.

**Default Setting**

None

**Command Mode**

Privileged Exec

**Command Usage**

- Use this command in conjunction with the **show startup-config** command to compare the information in running memory to the information stored in non-volatile memory.
- This command displays settings for key command modes. Each mode group is separated by “!” symbols, and includes the configuration mode command, and corresponding commands. This command displays the following information:
  - Switch’s MAC address
  - SNTP and NTP server settings
  - 802.1Q tunnel settings
  - Power over Ethernet settings
  - Broadcast storm control settings
  - SNMP community strings
  - Users (names and access levels)
  - Event log settings
  - VLAN database (VLAN ID, name and state)
  - VLAN configuration settings for each interface
  - Multiple spanning tree instances (name and interfaces)
  - IP address configured for the switch
  - Spanning tree settings
  - Interface settings
  - Any configured settings for the console port and Telnet

## Example

```
Console#show startup-config
building startup-config, please wait...
!<stackingDB>00</stackingDB>
!<stackingMac>01_00-16-b6-f0-6f-fd_00</stackingMac>
!
phymap 00-16-b6-f0-6f-fd
!
snmp server 0.0.0.0 0.0.0.0 0.0.0.0
!
ntp poll 16
!
no dot1q-tunnel system-tunnel-control
!
power mainpower maximum allocation 180 unit 1
!
snmp-server community public ro
snmp-server community private rw
!
username admin access-level 15
username admin password 7 21232f297a57a5a743894a0e4a801fc3
username guest access-level 0
username guest password 7 084e0343a0486ff05530df6c705c8bb4
enable password level 15 7 1b3231655cebb7a1f783eddf27d254ca
!
vlan database
  vlan 1 name DefaultVlan media ethernet state active
  vlan 4093 media ethernet state active
!
spanning-tree mst configuration
!
interface vlan 1
  ip address dhcp
!
interface ethernet 1/1
  switchport allowed vlan add 1 untagged
  switchport native vlan 1
  switchport allowed vlan add 4093 tagged
:
:
!
ip name-server auto
!
line console
  silent-time 0
!
line VTY
!
end
!
Console#
```

## Related Commands

show startup-config (4-27)



## show system

This command displays system information.

### Command Mode

Normal Exec, Privileged Exec

### Command Usage

- For a description of the items shown by this command, refer to “Displaying System Information” on page 3-12.
- The POST results should all display “PASS.” If any POST test indicates “FAIL,” contact your distributor for assistance.

### Example

```
Console#show system
System Description: L2 Fast Ethernet POE standalone Switch
System OID String: 1.3.6.1.4.1.236.4.1.12.1.101
System Information
System Up Time:          0 days, 0 hours, 1 minutes, and 32.18 seconds
System Name:            [NONE]
System Location:        [NONE]
System Contact:         [NONE]
MAC Address (Unit1):    00-00-35-28-10-03
Web Server:             Enabled
Web Server Port:        80
Web Secure Server:      Enabled
Web Secure Server Port: 443
Telnet Server:          Enable
Telnet Server Port:     23
Jumbo Frame:            Disabled

POST Result:
DUMMY Test 1 ..... PASS
UART Loopback Test ..... PASS
DRAM Test ..... PASS
Timer Test ..... PASS
Switch Int Loopback Test ..... PASS

Done All Pass.
Console#
```

## show users

Shows all active console and Telnet sessions, including user name, idle time, and IP address of Telnet client.

### Command Mode

Normal Exec, Privileged Exec

### Command Usage

The session used to execute this command is indicated by a “\*” symbol next to the Line (i.e., session) index number.

## Example

```
Console#show users
Username accounts:
  Username Privilege Public-Key
  -----
      admin          15      None
      guest           0      None
      steve           15      RSA

Online users:
  Line      Username Idle time (h:m:s) Remote IP addr.
  -----
  0 console   admin      0:14:14
* 1 VTY 0      admin      0:00:00   192.168.1.19
  2 SSH 1     steve      0:00:06   192.168.1.19

Web online users:
  Line      Remote IP addr Username Idle time (h:m:s).
  -----
  1 HTTP    192.168.1.19  admin      0:00:00

Console#
```

## show version

This command displays hardware and software version information for the system.

## Command Mode

Normal Exec, Privileged Exec

## Command Usage

See “Displaying Switch Hardware/Software Versions” on page 3-14 for detailed information on the items displayed by this command.

## Example

```
Console#show version
Unit1
Serial Number:          S416000937
Hardware Version:       R01
EPLD Version:           0.02
Number of Ports:        28
Main Power Status:      Up
Redundant Power Status: Not present

Agent (Master)
Unit ID:                 1
Loader Version:          1.0.0.1
Boot ROM Version:        1.0.0.10
Operation Code Version:  1.1.0.13

Console#
```

## Frame Size Commands

This section describes commands used to configure the Ethernet frame size on the switch.

Table 4-10 Frame Size Commands

Command	Function	Mode	Page
jumbo frame	Enables support for jumbo frames	GC	4-33

### jumbo frame

This command enables support for jumbo frames. Use the **no** form to disable it.

### Syntax

[no] jumbo frame

### Default Setting

Disabled

### Command Mode

Global Configuration

### Command Usage

- This switch provides more efficient throughput for large sequential data transfers by supporting jumbo frames up to 10 KB for the Gigabit Ethernet ports. Compared to standard Ethernet frames that run only up to 1.5 KB, using jumbo frames significantly reduces the per-packet overhead required to process protocol encapsulation fields.
- To use jumbo frames, both the source and destination end nodes (such as a computer or server) must support this feature. Also, when the connection is operating at full duplex, all switches in the network between the two end nodes must be able to accept the extended frame size. And for half-duplex connections, all devices in the collision domain would need to support jumbo frames.
- The current setting for jumbo frames can be displayed with the show system command (page 4-31).

### Example

```
Console(config)#jumbo frame
Console(config)#
```

## File Management Commands

### Managing Firmware

Firmware can be uploaded and downloaded to or from a TFTP server. By saving runtime code to a file on a TFTP server, that file can later be downloaded to the switch to restore operation. The switch can also be set to use new firmware without overwriting the previous version.

When downloading runtime code, the destination file name can be specified to replace the current image, or the file can be first downloaded using a different name from the current runtime code file, and then the new file set as the startup file.

### Saving or Restoring Configuration Settings

Configuration settings can be uploaded and downloaded to and from a TFTP server. The configuration file can be later downloaded to restore switch settings.

The configuration file can be downloaded under a new file name and then set as the startup file, or the current startup configuration file can be specified as the destination file to directly replace it. Note that the file "Factory\_Default\_Config.cfg" can be copied to the TFTP server, but cannot be used as the destination on the switch.

**Table 4-11 Flash/File Commands**

Command	Function	Mode	Page
copy	Copies a code image or a switch configuration to or from flash memory or a TFTP server	PE	4-35
delete	Deletes a file or code image	PE	4-37
dir	Displays a list of files in flash memory	PE	4-38
whichboot	Displays the files booted	PE	4-39
boot system	Specifies the file or image used to start up the system	GC	4-39

## copy

This command moves (upload/download) a code image or configuration file between the switch's flash memory and a TFTP server. When you save the system code or configuration settings to a file on a TFTP server, that file can later be downloaded to the switch to restore system operation. The success of the file transfer depends on the accessibility of the TFTP server and the quality of the network connection.

### Syntax

```
copy file {file | running-config | startup-config | tftp}  
copy running-config {file | startup-config | tftp}  
copy startup-config {file | running-config | tftp}  
copy tftp {file | running-config | startup-config | https-certificate |  
public-key}
```

- **file** - Keyword that allows you to copy to/from a file.
- **running-config** - Keyword that allows you to copy to/from the current running configuration.
- **startup-config** - The configuration used for system initialization.
- **tftp** - Keyword that allows you to copy to/from a TFTP server.
- **https-certificate** - Copies an HTTPS certificate from an TFTP server to the switch.
- **public-key** - Keyword that allows you to copy a SSH key from a TFTP server. ("Secure Shell Commands" on page 4-127)

### Default Setting

None

### Command Mode

Privileged Exec

### Command Usage

- The system prompts for data required to complete the copy command.
- The destination file name should not contain slashes (\ or /), the leading letter of the file name should not be a period (.), and the maximum length for file names on the TFTP server is 127 characters or 31 characters for files on the switch. (Valid characters: A-Z, a-z, 0-9, ".", "-", "\_")
- Due to the size limit of the flash memory, the switch supports only one operation code file.
- The maximum number of user-defined configuration files depends on available memory.
- You can use "Factory\_Default\_Config.cfg" as the source to copy from the factory default configuration file, but you cannot use it as the destination.
- To replace the startup configuration, you must use **startup-config** as the destination.

## 4 Command Line Interface

- The Boot ROM and Loader cannot be uploaded or downloaded from the TFTP server. You must follow the instructions in the release notes for new firmware, or contact your distributor for help.
- For information on specifying an https-certificate, see “Replacing the Default Secure-site Certificate” on page 3-78. For information on configuring the switch to use HTTPS for a secure connection, see “ip http secure-server” on page 4-124.

### Example

The following example shows how to download new firmware from a TFTP server:

```
Console#copy tftp file
TFTP server ip address: 10.1.0.19
Choose file type:
 1. config:  2. opcode: <1-2>: 2
Source file name: V1.0.0.5.bix
Destination file name: V1.0.0.5.bix
\Write to FLASH Programming.
-Write to FLASH finish.
Success.
Console#
```

The following example shows how to upload the configuration settings to a file on the TFTP server:

```
Console#copy file tftp
Choose file type:
 1. config:  2. opcode: <1-2>: 1
Source file name: startup
TFTP server ip address: 10.1.0.99
Destination file name: startup.01
TFTP completed.
Success.
Console#
```

The following example shows how to copy the running configuration to a startup file.

```
Console#copy running-config file
destination file name: startup
Write to FLASH Programming.
\Write to FLASH finish.
Success.
Console#
```

The following example shows how to download a configuration file:

```
Console#copy tftp startup-config
TFTP server ip address: 10.1.0.99
Source configuration file name: startup.01
Startup configuration file name [startup]:
Write to FLASH Programming.

\Write to FLASH finish.
Success.

Console#
```

This example shows how to copy a secure-site certificate from an TFTP server. It then reboots the switch to activate the certificate:

```
Console#copy tftp https-certificate
TFTP server ip address: 10.1.0.19
Source certificate file name: SS-certificate
Source private file name: SS-private
Private password: *****

Success.
Console#reload
System will be restarted, continue <y/n>? y
```

This example shows how to copy a public-key used by SSH from a TFTP server. Note that public key authentication via SSH is only supported for users configured locally on the switch:

```
Console#copy tftp public-key
TFTP server IP address: 192.168.1.19
Choose public key type:
 1. RSA:  2. DSA: <1-2>: 1
Source file name: steve.pub
Username: steve
TFTP Download
Success.
Write to FLASH Programming.
Success.

Console#
```

## delete

This command deletes a file or image.

### Syntax

**delete** *filename*

*filename* - Name of the configuration file or image name.

### Command Mode

Privileged Exec

## Command Usage

- If the file type is used for system startup, then this file cannot be deleted.
- “Factory\_Default\_Config.cfg” cannot be deleted.

## Example

This example shows how to delete the test2.cfg configuration file from flash memory.

```
Console#delete test2.cfg
Console#
```

## Related Commands

- dir (4-38)
- delete public-key (4-131)

## dir

This command displays a list of files in flash memory.

## Syntax

**dir** {{**boot-rom**: | **config**: | **opcode**:} [*filename*]}

The type of file or image to display includes:

- **boot-rom** - Boot ROM (or diagnostic) image file.
- **config** - Switch configuration file.
- **opcode** - Run-time operation code image file.
- *filename* - Name of the configuration file or code image.

## Default Setting

None

## Command Mode

Privileged Exec

## Command Usage

- If you enter the command **dir** without any parameters, the system displays all files.
- File information is shown below:

Table 4-12 File Directory Information

Column Heading	Description
file name	The name of the file.
file type	File types: Boot-Rom, Operation Code, and Config file.
startup	Shows if this file is used when the system is started.
size	The length of the file in bytes.



**Example**

The following example shows how to display all file information:

(byte)	File name	File type	Startup Size	
-----				
Unit1:	diag.bix	Boot-Rom Image	N	1377600
	iES4028FP_bootrom_V1.0.0.10.bix	Boot-Rom Image	Y	1398712
	iES4028FP_V1.1.0.13.bix	Operation Code	Y	3961940
	Factory_Default_Config.cfg	Config File	N	455
	startup1.cfg	Config File	Y	4667
-----				
			Total free space:	0
Console#				

**whichboot**

This command displays which files were booted when the system powered up.

**Command Mode**

Privileged Exec

**Example**

This example shows the information displayed by the **whichboot** command. See the table under the **dir** command for a description of the file information displayed by this command.

Console#	File name	File type	Startup Size	(byte)
-----				
Unit1:	iES4028FP_bootrom_V1.0.0.10.bix	Boot-Rom Image	Y	1398712
	iES4028FP_V1.1.0.13.bix	Operation Code	Y	3961940
	startup1.cfg	Config File	Y	4667
Console#				

**boot system**

This command specifies the image used to start up the system.

**Syntax**

**boot system {boot-rom| config | opcode}: filename**

The type of file or image to set as a default includes:

- **boot-rom\*** - Boot ROM.
- **config\*** - Configuration file.
- **opcode\*** - Run-time operation code.
- **filename** - Name of the configuration file or code image.

\* The colon (:) is required.

**Default Setting**

None

## Command Mode

Global Configuration

## Command Usage

- A colon (:) is required after the specified unit number and file type.
- If the file contains an error, it cannot be set as the default file.

## Example

```
Console(config)#boot system config: startup
Console(config)#
```

## Related Commands

dir (4-38)

whichboot (4-39)

## Line Commands

You can access the onboard configuration program by attaching a VT100 compatible device to the server's serial port. These commands are used to set communication parameters for the serial port or Telnet (i.e., a virtual terminal).

Table 4-13 Line Commands

Command	Function	Mode	Page
line	Identifies a specific line for configuration and starts the line configuration mode	GC	4-41
login	Enables password checking at login	LC	4-41
password	Specifies a password on a line	LC	4-42
timeout login response	Sets the interval that the system waits for a user to log into the CLI	LC	4-43
exec-timeout	Sets the interval that the command interpreter waits until user input is detected	LC	4-44
password-thresh	Sets the password intrusion threshold, which limits the number of failed logon attempts	LC	4-44
silent-time*	Sets the amount of time the management console is inaccessible after the number of unsuccessful logon attempts exceeds the threshold set by the <b>password-thresh</b> command	LC	4-45
databits*	Sets the number of data bits per character that are interpreted and generated by hardware	LC	4-46
parity*	Defines the generation of a parity bit	LC	4-46
speed*	Sets the terminal baud rate	LC	4-47
stopbits*	Sets the number of the stop bits transmitted per byte	LC	4-47
disconnect	Terminates a line connection	PE	4-48
show line	Displays a terminal line's parameters	NE, PE	4-48

\* These commands only apply to the serial port.

## line

This command identifies a specific line for configuration, and to process subsequent line configuration commands.

### Syntax

**line** {**console** | **vty**}

- **console** - Console terminal line.
- **vty** - Virtual terminal for remote console access (i.e., Telnet).

### Default Setting

There is no default line.

### Command Mode

Global Configuration

### Command Usage

Telnet is considered a virtual terminal connection and will be shown as “VTY” in screen displays such as **show users**. However, the serial communication parameters (e.g., databits) do not affect Telnet connections.

### Example

To enter console line mode, enter the following command:

```
Console(config)#line console
Console(config-line)#
```

### Related Commands

show line (4-48)  
show users (4-31)

## login

This command enables password checking at login. Use the **no** form to disable password checking and allow connections without a password.

### Syntax

**login** [**local**]  
**no login**

**local** - Selects local password checking. Authentication is based on the user name specified with the **username** command.

### Default Setting

login local

### Command Mode

Line Configuration

## Command Usage

- There are three authentication modes provided by the switch itself at login:
  - **login** selects authentication by a single global password as specified by the **password** line configuration command. When using this method, the management interface starts in Normal Exec (NE) mode.
  - **login local** selects authentication via the user name and password specified by the **username** command (i.e., default setting). When using this method, the management interface starts in Normal Exec (NE) or Privileged Exec (PE) mode, depending on the user's privilege level (0 or 15 respectively).
  - **no login** selects no authentication. When using this method, the management interface starts in Normal Exec (NE) mode.
- This command controls login authentication via the switch itself. To configure user names and passwords for remote authentication servers, you must use the RADIUS or TACACS software installed on those servers.

## Example

```
Console(config-line)#login local
Console(config-line)#
```

## Related Commands

username (4-101)  
password (4-42)

## password

This command specifies the password for a line. Use the **no** form to remove the password.

## Syntax

```
password {0 | 7} password  
no password
```

- {0 | 7} - 0 means plain password, 7 means encrypted password
- *password* - Character string that specifies the line password.  
(Maximum length: 8 characters plain text, 32 encrypted, case sensitive)

## Default Setting

No password is specified.

## Command Mode

Line Configuration

## Command Usage

- When a connection is started on a line with password protection, the system prompts for the password. If you enter the correct password, the system shows a prompt. You can use the **password-thresh** command to set the

number of times a user can enter an incorrect password before the system terminates the line connection and returns the terminal to the idle state.

- The encrypted password is required for compatibility with legacy password settings (i.e., plain text or encrypted) when reading the configuration file during system bootup or when downloading the configuration file from a TFTP server. There is no need for you to manually configure encrypted passwords.

### Example

```
Console(config-line)#password 0 secret
Console(config-line)#
```

### Related Commands

login (4-41)

password-thresh (4-44)

### timeout login response

This command sets the interval that the system waits for a user to log into the CLI. Use the **no** form to restore the default.

### Syntax

**timeout login response** [*seconds*]

**no timeout login response**

*seconds* - Integer that specifies the timeout interval.

(Range: 0 - 300 seconds; 0: disabled)

### Default Setting

- CLI: Disabled (0 seconds)
- Telnet: 600 seconds

### Command Mode

Line Configuration

### Command Usage

- If a login attempt is not detected within the timeout interval, the connection is terminated for the session.
- This command applies to both the local console and Telnet connections.
- The timeout for Telnet cannot be disabled.
- Using the command without specifying a timeout restores the default setting.

### Example

To set the timeout to two minutes, enter this command:

```
Console(config-line)#timeout login response 120
Console(config-line)#
```

## 4 Command Line Interface

### Related Commands

silent-time (4-45)  
exec-timeout (4-14)

### exec-timeout

This command sets the interval that the system waits until user input is detected. Use the **no** form to restore the default.

### Syntax

**exec-timeout** [*seconds*]  
**no exec-timeout**

*seconds* - Integer that specifies the number of seconds.  
(Range: 0-65535 seconds; 0: no timeout)

### Default Setting

CLI: No timeout  
Telnet: 10 minutes

### Command Mode

Line Configuration

### Command Usage

- If user input is detected within the timeout interval, the session is kept open; otherwise the session is terminated.
- This command applies to both the local console and Telnet connections.
- The timeout for Telnet cannot be disabled.
- Using the command without specifying a timeout restores the default setting.

### Example

To set the timeout to two minutes, enter this command:

```
Console(config-line)#exec-timeout 120  
Console(config-line)#
```

### Related Commands

silent-time (4-45)  
timeout login response (4-13)

### password-thresh

This command sets the password intrusion threshold which limits the number of failed logon attempts. Use the **no** form to remove the threshold value.

### Syntax

**password-thresh** [*threshold*]  
**no password-thresh**

*threshold* - The number of allowed password attempts.  
(Range: 1-120; 0: no threshold)

### Default Setting

The default value is three attempts.

### Command Mode

Line Configuration

### Command Usage

- When the logon attempt threshold is reached, the system interface becomes silent for a specified amount of time before allowing the next logon attempt. (Use the **silent-time** command to set this interval.) When this threshold is reached for Telnet, the Telnet logon interface shuts down.
- This command applies to both the local console and Telnet connections.

### Example

To set the password threshold to five attempts, enter this command:

```
Console(config-line)#password-thresh 5
Console(config-line)#
```

### Related Commands

silent-time (4-45)

timeout login response (4-13)

### silent-time

This command sets the amount of time the management console is inaccessible after the number of unsuccessful logon attempts exceeds the threshold set by the **password-thresh** command. Use the **no** form to remove the silent time value.

### Syntax

**silent-time** [*seconds*]  
**no silent-time**

*seconds* - The number of seconds to disable console response.  
(Range: 0-65535; 0: no silent-time)

### Default Setting

The default value is no silent-time.

### Command Mode

Line Configuration

### Example

To set the silent time to 60 seconds, enter this command:

```
Console(config-line)#silent-time 60
Console(config-line)#
```

### Related Commands

password-thresh (4-44)

### **databits**

This command sets the number of data bits per character that are interpreted and generated by the console port. Use the **no** form to restore the default value.

#### **Syntax**

**databits** {7 | 8}

**no** **databits**

- 7 - Seven data bits per character.
- 8 - Eight data bits per character.

#### **Default Setting**

8 data bits per character

#### **Command Mode**

Line Configuration

#### **Command Usage**

The **databits** command can be used to mask the high bit on input from devices that generate 7 data bits with parity. If parity is being generated, specify 7 data bits per character. If no parity is required, specify 8 data bits per character.

#### **Example**

To specify 7 data bits, enter this command:

```
Console(config-line)#databits 7
Console(config-line)#
```

#### **Related Commands**

parity (4-46)

### **parity**

This command defines the generation of a parity bit. Use the **no** form to restore the default setting.

#### **Syntax**

**parity** {none | even | odd}

**no** **parity**

- **none** - No parity
- **even** - Even parity
- **odd** - Odd parity

#### **Default Setting**

No parity

#### **Command Mode**

Line Configuration



## Command Usage

Communication protocols provided by devices such as terminals and modems often require a specific parity bit setting.

### Example

To specify no parity, enter this command:

```
Console(config-line)#parity none
Console(config-line)#
```

## speed

This command sets the terminal line's baud rate. This command sets both the transmit (to terminal) and receive (from terminal) speeds. Use the **no** form to restore the default setting.

### Syntax

**speed** *bps*

**no speed**

*bps* - Baud rate in bits per second.  
(Options: 9600, 19200, 38400 bps)

### Default Setting

9600

### Command Mode

Line Configuration

## Command Usage

Set the speed to match the baud rate of the device connected to the serial port. Some baud rates available on devices connected to the port might not be supported. The system indicates if the speed you selected is not supported.

### Example

To specify 38400 bps, enter this command:

```
Console(config-line)#speed 38400
Console(config-line)#
```

## stopbits

This command sets the number of the stop bits transmitted per byte. Use the **no** form to restore the default setting.

### Syntax

**stopbits** {1 | 2}

- 1 - One stop bit
- 2 - Two stop bits

## 4 Command Line Interface

### Default Setting

1 stop bit

### Command Mode

Line Configuration

### Example

To specify 2 stop bits, enter this command:

```
Console(config-line)#stopbits 2
Console(config-line)#
```

### disconnect

This command terminates an SSH, Telnet, or console connection.

### Syntax

**disconnect** *session-id*

*session-id* – The session identifier for an SSH, Telnet or console connection. (Range: 0-4)

### Command Mode

Privileged Exec

### Command Usage

Specifying session identifier "0" will disconnect the console connection. Specifying any other identifiers for an active session will disconnect an SSH or Telnet connection.

### Example

```
Console#disconnect 1
Console#
```

### Related Commands

show ssh (4-134)  
show users (4-31)

### show line

This command displays the terminal line's parameters.

### Syntax

**show line** [**console** | **vtty**]

- **console** - Console terminal line.
- **vtty** - Virtual terminal for remote console access (i.e., Telnet).

### Default Setting

Shows all lines

## Command Mode

Normal Exec, Privileged Exec

## Example

To show all lines, enter this command:

```

Console#show line
Console configuration:
  Password threshold: 3 times
  Interactive timeout: Disabled
  Login timeout: Disabled
  Silent time: Disabled
  Baudrate: 9600
  Databits: 8
  Parity: none
  Stopbits: 1

VTY configuration:
  Password threshold: 3 times
  Interactive timeout: 600 sec
  Login timeout: 300 sec
console#
  
```

## Event Logging Commands

This section describes commands used to configure event logging on the switch.

**Table 4-14 Event Logging Commands**

Command	Function	Mode	Page
logging on	Controls logging of error messages	GC	4-49
logging history	Limits syslog messages saved to switch memory based on severity	GC	4-50
logging host	Adds a syslog server host IP address that will receive logging messages	GC	4-51
logging facility	Sets the facility type for remote logging of syslog messages	GC	4-51
logging trap	Limits syslog messages saved to a remote server based on severity	GC	4-52
clear log	Clears messages from the logging buffer	PE	4-53
show logging	Displays the state of logging	PE	4-53
show log	Displays log messages	PE	4-55

### logging on

This command controls logging of error messages, sending debug or error messages to switch memory. The **no** form disables the logging process.

### Syntax

[no] logging on

### Default Setting

None

## Command Mode

Global Configuration

## Command Usage

The logging process controls error messages saved to switch memory or sent to remote syslog servers. You can use the **logging history** command to control the type of error messages that are stored in memory. You can use the **logging trap** command to control the type of error messages that are sent to specified syslog servers.

## Example

```
Console(config)#logging on  
Console(config)#
```

## Related Commands

logging history (4-50)

logging trap (4-52)

clear log (4-53)

## logging history

This command limits syslog messages saved to switch memory based on severity. The **no** form returns the logging of syslog messages to the default level.

## Syntax

**logging history** {flash | ram} level

**no logging history** {flash | ram}

- **flash** - Event history stored in flash memory (i.e., permanent memory).
- **ram** - Event history stored in temporary RAM (i.e., memory flushed on power reset).
- **level** - One of the levels listed below. Messages sent include the selected level down to level 0. (Range: 0-7)

Table 4-15 Logging Levels

Level	Severity Name	Description
7	debugging	Debugging messages
6	informational	Informational messages only
5	notifications	Normal but significant condition, such as cold start
4	warnings	Warning conditions (e.g., return false, unexpected return)
3	errors	Error conditions (e.g., invalid input, default used)
2	critical	Critical conditions (e.g., memory allocation, or free memory error - resource exhausted)
1	alerts	Immediate action needed
0	emergencies	System unusable

\* There are only Level 2, 5, 6 and 7 error messages for the current firmware release.

### Default Setting

Flash: errors (level 3 - 0)  
RAM: warnings (level 7 - 0)

### Command Mode

Global Configuration

### Command Usage

The message level specified for flash memory must be a higher priority (i.e., numerically lower) than that specified for RAM.

### Example

```
Console(config)#logging history ram 0
Console(config)#
```

### logging host

This command adds a syslog server host IP address that will receive logging messages. Use the **no** form to remove a syslog server host.

### Syntax

**[no] logging host** *host\_ip\_address*  
*host\_ip\_address* - The IP address of a syslog server.

### Default Setting

None

### Command Mode

Global Configuration

### Command Usage

- Use this command more than once to build up a list of host IP addresses.
- The maximum number of host IP addresses allowed is five.

### Example

```
Console(config)#logging host 10.1.0.3
Console(config)#
```

### logging facility

This command sets the facility type for remote logging of syslog messages. Use the **no** form to return the type to the default.

### Syntax

**[no] logging facility** *type*  
*type* - A number that indicates the facility used by the syslog server to dispatch log messages to an appropriate service. (Range: 16-23)

## Default Setting

23

## Command Mode

Global Configuration

## Command Usage

The command specifies the facility type tag sent in syslog messages. (See RFC 3164.) This type has no effect on the kind of messages reported by the switch. However, it may be used by the syslog server to sort messages or to store messages in the corresponding database.

## Example

```
Console(config)#logging facility 19
Console(config)#
```

## logging trap

This command enables the logging of system messages to a remote server, or limits the syslog messages saved to a remote server based on severity. Use this command without a specified level to enable remote logging. Use the **no** form to disable remote logging.

## Syntax

**logging trap** [*level*]

**no logging trap**

*level* - One of the level arguments listed below. Messages sent include the selected level up through level 0. (Refer to the table on page 4-50.)

## Default Setting

- Enabled
- Level 7 - 0

## Command Mode

Global Configuration

## Command Usage

- Using this command with a specified level enables remote logging and sets the minimum severity level to be saved.
- Using this command without a specified level also enables remote logging, but restores the minimum severity level to the default.

## Example

```
Console(config)#logging trap 4
Console(config)#
```

## clear log

This command clears messages from the log buffer.

### Syntax

**clear log** [**flash** | **ram**]

- **flash** - Event history stored in flash memory (i.e., permanent memory).
- **ram** - Event history stored in temporary RAM (i.e., memory flushed on power reset).

### Default Setting

Flash and RAM

### Command Mode

Privileged Exec

## Example

```
Console#clear log
Console#
```

## Related Commands

show logging (4-53)

## show logging

This command displays the configuration settings for logging messages to local switch memory, to an SMTP event handler, or to a remote syslog server.

### Syntax

**show logging** {**flash** | **ram** | **sendmail** | **trap**}

- **flash** - Displays settings for storing event messages in flash memory (i.e., permanent memory).
- **ram** - Displays settings for storing event messages in temporary RAM (i.e., memory flushed on power reset).
- **sendmail** - Displays settings for the SMTP event handler (page 4-58).
- **trap** - Displays settings for the trap function.

### Default Setting

None

### Command Mode

Privileged Exec

## Example

The following example shows that system logging is enabled, the message level for flash memory is “errors” (i.e., default level 3 - 0), the message level for RAM is “informational” (i.e., default level 7 - 0).

```

Console#show logging flash
Syslog logging:           Enabled
History logging in FLASH: level errors
Console#show logging ram
Syslog logging:           Enabled
History logging in RAM: level informational
Console#
    
```

**Table 4-16 show logging flash/ram - display description**

Field	Description
Syslog logging	Shows if system logging has been enabled via the <b>logging on</b> command.
History logging in FLASH	The message level(s) reported based on the <b>logging history</b> command.
History logging in RAM	The message level(s) reported based on the <b>logging history</b> command.

The following example displays settings for the trap function.

```

Console#show logging trap
Syslog logging: Enable
REMOTELOG status: disable
REMOTELOG facility type: local use 7
REMOTELOG level type: Debugging messages
REMOTELOG server IP address: 1.2.3.4
REMOTELOG server IP address: 0.0.0.0
REMOTELOG server IP address: 0.0.0.0
REMOTELOG server IP address: 0.0.0.0
REMOTELOG server IP address: 0.0.0.0
Console#
    
```

**Table 4-17 show logging trap - display description**

Field	Description
Syslog logging	Shows if system logging has been enabled via the <b>logging on</b> command.
REMOTELOG status	Shows if remote logging has been enabled via the <b>logging trap</b> command.
REMOTELOG facility type	The facility type for remote logging of syslog messages as specified in the <b>logging facility</b> command.
REMOTELOG level type	The severity threshold for syslog messages sent to a remote server as specified in the <b>logging trap</b> command.
REMOTELOG server IP address	The address of syslog servers as specified in the <b>logging host</b> command.

## Related Commands

show logging sendmail (4-58)



## show log

This command displays the system and event messages stored in memory.

### Syntax

**show log {flash | ram} [login]**

- **flash** - Event history stored in flash memory (i.e., permanent memory).
- **ram** - Event history stored in temporary RAM (i.e., memory flushed on power reset).
- **login** - Shows the login record only.

### Default Setting

None

### Command Mode

Privileged Exec

### Command Usage

This command shows the system and event messages stored in memory, including the time stamp, message level (page 4-50), program module, function, and event number.

### Example

The following example shows sample messages stored in RAM.

```
Console#show log ram
[5] 00:01:06 2001-01-01
   "STA root change notification."
   level: 6, module: 6, function: 1, and event no.: 1
[4] 00:01:00 2001-01-01
   "STA root change notification."
   level: 6, module: 6, function: 1, and event no.: 1
[3] 00:00:54 2001-01-01
   "STA root change notification."
   level: 6, module: 6, function: 1, and event no.: 1
[2] 00:00:50 2001-01-01
   "STA topology change notification."
   level: 6, module: 6, function: 1, and event no.: 1
[1] 00:00:48 2001-01-01
   "VLAN 1 link-up notification."
   level: 6, module: 6, function: 1, and event no.: 1
Console#
```

## SMTP Alert Commands

These commands configure SMTP event handling, and forwarding of alert messages to the specified SMTP servers and email recipients.

**Table 4-18 SMTP Alert Commands**

Command	Function	Mode	Page
logging sendmail host	SMTP servers to receive alert messages	GC	4-56
logging sendmail level	Severity threshold used to trigger alert messages	GC	4-57
logging sendmail source-email	Email address used for "From" field of alert messages	GC	4-57
logging sendmail destination-email	Email recipients of alert messages	GC	4-58
logging sendmail	Enables SMTP event handling	GC	4-58
show logging sendmail	Displays SMTP event handler settings	NE, PE	4-58

### logging sendmail host

This command specifies SMTP servers that will be sent alert messages. Use the **no** form to remove an SMTP server.

#### Syntax

**[no] logging sendmail host** *ip\_address*

*ip\_address* - IP address of an SMTP server that will be sent alert messages for event handling.

#### Default Setting

None

#### Command Mode

Global Configuration

#### Command Usage

- You can specify up to three SMTP servers for event handling. However, you must enter a separate command to specify each server.
- To send email alerts, the switch first opens a connection, sends all the email alerts waiting in the queue one by one, and finally closes the connection.
- To open a connection, the switch first selects the server that successfully sent mail during the last connection, or the first server configured by this command. If it fails to send mail, the switch selects the next server in the list and tries to send mail again. If it still fails, the system will repeat the process at a periodic interval. (A trap will be triggered if the switch cannot successfully open a connection.)

#### Example

```
Console(config)#logging sendmail host 192.168.1.200
Console(config)#
```

## logging sendmail level

This command sets the severity threshold used to trigger alert messages.

### Syntax

**logging sendmail level** *level*

*level* - One of the system message levels (page 4-50). Messages sent include the selected level down to level 0. (Range: 0-7; Default: 7)

### Default Setting

Level 7

### Command Mode

Global Configuration

### Command Usage

The specified level indicates an event threshold. All events at this level or higher will be sent to the configured email recipients. (For example, using Level 7 will report all events from level 7 to level 0.)

### Example

This example will send email alerts for system errors from level 4 through 0.

```
Console(config)#logging sendmail level 4
Console(config)#
```

## logging sendmail source-email

This command sets the email address used for the “From” field in alert messages. Use the **no** form to delete the source email address.

### Syntax

**[no] logging sendmail source-email** *email-address*

*email-address* - The source email address used in alert messages.  
(Range: 0-41 characters)

### Default Setting

None

### Command Mode

Global Configuration

### Command Usage

You may use an symbolic email address that identifies the switch, or the address of an administrator responsible for the switch.

### Example

This example will set the source email john@samsung.com.

```
Console(config)#logging sendmail source-email john@samsung.com
Console(config)#
```

### logging sendmail destination-email

This command specifies the email recipients of alert messages. Use the **no** form to remove a recipient.

#### Syntax

**[no] logging sendmail destination-email** *email-address*

*email-address* - The source email address used in alert messages.  
(Range: 1-41 characters)

#### Default Setting

None

#### Command Mode

Global Configuration

#### Command Usage

You can specify up to five recipients for alert messages. However, you must enter a separate command to specify each recipient.

#### Example

```
Console(config)#logging sendmail destination-email ted@this-company.com
Console(config)#
```

### logging sendmail

This command enables SMTP event handling. Use the **no** form to disable this function.

#### Syntax

**[no] logging sendmail**

#### Default Setting

Enabled

#### Command Mode

Global Configuration

#### Example

```
Console(config)#logging sendmail
Console(config)#
```

### show logging sendmail

This command displays the settings for the SMTP event handler.

#### Command Mode

Normal Exec, Privileged Exec

## Example

```

Console#show logging sendmail
SMTP servers
-----
 1. 192.168.1.200

SMTP minimum severity level: 4

SMTP destination email addresses
-----
 1. geoff@samsung.com

SMTP source email address:   john@samsung.com

SMTP status:                 Enabled
Console#

```

## Time Commands

The system clock can be dynamically set by polling a set of specified time servers (NTP or SNTP). Maintaining an accurate time on the switch enables the system log to record meaningful dates and times for event entries. If the clock is not set, the switch will only record the time from the factory default set at the last bootup.

**Table 4-19 Time Commands**

Command	Function	Mode	Page
<i>SNTP Commands</i>			
sntp client	Accepts time from specified time servers	GC	4-60
sntp server	Specifies one or more time servers	GC	4-61
sntp poll	Sets the interval at which the client polls for time	GC	4-61
show sntp	Shows current SNTP configuration settings	NE, PE	4-62
<i>NTP Commands</i>			
ntp client	Enables the NTP client for time updates from specified servers	GC	4-62
ntp server	Specifies NTP servers to poll for time updates	GC	4-63
ntp poll	Sets the interval at which the NTP client polls for time	GC	4-64
ntp authenticate	Enables authentication for NTP traffic	GC	4-64
ntp authentication-key	Configures authentication keys	GC	4-65
show ntp	Shows current NTP configuration settings	NE, PE	4-66
<i>Manual Configuration Commands</i>			
clock timezone-predefined	Sets the time zone for the switch's internal clock using predefined time zone configurations	GC	4-67
clock timezone	Manually sets the time zone for the switch's internal clock	GC	4-67
clock summertime (date)	Configures summer time (daylight savings time) for the switch's internal clock	GC	4-68
clock summertime (predefined)	Configures summer time (daylight savings time) for the switch's internal clock	GC	4-69

**Table 4-19 Time Commands (Continued)**

Command	Function	Mode	Page
clock summertime (recurring)	Configures summer time (daylight savings time) for the switch's internal clock	GC	4-70
calendar set	Sets the system date and time	PE	4-72
show calendar	Displays the current date and time setting	NE, PE	4-72

## ntp client

This command enables SNTP client requests for time synchronization from NTP or SNTP time servers specified with the **ntp servers** command. Use the **no** form to disable SNTP client requests.

### Syntax

**[no] ntp client**

### Default Setting

Disabled

### Command Mode

Global Configuration

### Command Usage

- The time acquired from time servers is used to record accurate dates and times for log events. Without SNTP, the switch only records the time starting from the factory default set at the last bootup (i.e., 00:00:00, Jan. 1, 2001).
- This command enables client time requests to time servers specified via the **ntp servers** command. It issues time synchronization requests based on the interval set via the **ntp poll** command.

### Example

```

Console(config)#ntp server 10.1.0.19
Console(config)#ntp poll 60
Console(config)#ntp client
Console(config)#end
Console#show ntp
Current time: Dec 23 02:52:44 2002
Poll interval: 60
Current mode: unicast
SNTP status: Enabled
SNTP server: 10.1.0.19 0.0.0.0 0.0.0.0
Current server: 10.1.0.19
Console#

```

### Related Commands

- ntp server (4-61)
- ntp poll (4-61)
- show ntp (4-62)

### sntp server

This command sets the IP address of the servers to which SNTP time requests are issued. Use the this command with no arguments to clear all time servers from the current list.

#### Syntax

```
sntp server [ip1 [ip2 [ip3]]]
```

*ip* - IP address of a time server (NTP or SNTP).  
(Range: 1-3 addresses)

#### Default Setting

None

#### Command Mode

Global Configuration

#### Command Usage

This command specifies time servers from which the switch will poll for time updates when set to SNTP client mode. The client will poll the time servers in the order specified until a response is received. It issues time synchronization requests based on the interval set via the **sntp poll** command.

#### Example

```
Console(config)#sntp server 10.1.0.19
```

#### Related Commands

sntp client (4-60)  
sntp poll (4-61)  
show sntp (4-62)

### sntp poll

This command sets the interval between sending time requests when the switch is set to SNTP client mode. Use the **no** form to restore to the default.

#### Syntax

```
sntp poll seconds  
no sntp poll
```

*seconds* - Interval between time requests. (Range: 16-16384 seconds)

#### Default Setting

16 seconds

#### Command Mode

Global Configuration

### Example

```
Console(config)#sntp poll 60
Console(config)#
```

### Related Commands

sntp client (4-60)

### show sntp

This command displays the current time and configuration settings for the SNTP client, and indicates whether or not the local time has been properly updated.

### Command Mode

Normal Exec, Privileged Exec

### Command Usage

This command displays the current time, the poll interval used for sending time synchronization requests, and the current SNTP mode (i.e., unicast).

### Example

```
Console#show sntp
Current time: Dec 23 05:13:28 2002
Poll interval: 16
Current mode: unicast
SNTP status : Enabled
SNTP server 137.92.140.80 0.0.0.0 0.0.0.0
Current server: 137.92.140.80
Console#
```

### ntp client

This command enables NTP client requests for time synchronization from NTP time servers specified with the **ntp servers** command. Use the **no** form to disable NTP client requests.

### Syntax

[no] ntp client

### Default Setting

Disabled

### Command Mode

Global Configuration

### Command Usage

- SNTP and NTP clients cannot be enabled at the same time. First disable the SNTP client before using this command.
- The time acquired from time servers is used to record accurate dates and times for log events. Without NTP, the switch only records the time starting from the factory default set at the last bootup (i.e., 00:00:00, Jan. 1, 2001).



- This command enables client time requests to time servers specified via the **ntp servers** command. It issues time synchronization requests based on the interval set via the **ntp poll** command.

### Example

```
Console(config)#ntp client
Console(config)#
```

### Related Commands

- sntp client (4-60)
- ntp poll (4-64)
- ntp server (4-63)

### ntp server

This command sets the IP addresses of the servers to which NTP time requests are issued. Use the **no** form of the command to clear a specific time server or all servers from the current list.

### Syntax

```
ntp server ip-address [version number] [key key-number]
no ntp server [ip-address]
```

- *ip-address* - IP address of an NTP time server.
- *number* - The NTP version number supported by the server. (Range: 1-3)
- *key-number* - The number of an authentication key to use in communications with the server. (Range: 1-65535)

### Default Setting

Version number: 3

### Command Mode

Global Configuration

### Command Usage

- This command specifies time servers that the switch will poll for time updates when set to NTP client mode. It issues time synchronization requests based on the interval set with the **ntp poll** command. The client will poll all the time servers configured, the responses received are filtered and compared to determine the most reliable and accurate time update for the switch.
- You can configure up to 50 NTP servers on the switch. Re-enter this command for each server you want to configure.
- NTP authentication is optional. If enabled with the **ntp authenticate** command, you must also configure at least one key number using the **ntp authentication-key** command.
- Use the **no** form of this command without an argument to clear all configured servers in the list.

## 4 Command Line Interface

### Example

```
Console(config)#ntp server 192.168.3.20
Console(config)#ntp server 192.168.3.21
Console(config)#ntp server 192.168.4.22 version 2
Console(config)#ntp server 192.168.5.23 version 3 key 19
Console(config)#
```

### Related Commands

- ntp client (4-62)
- ntp poll (4-64)
- show ntp (4-66)

### ntp poll

This command sets the interval between sending time requests when the switch is set to NTP client mode. Use the **no** form to restore to the default.

### Syntax

```
ntp poll seconds
no ntp poll
```

*seconds* - Interval between time requests. (Range: 16-16384 seconds)

### Default Setting

16 seconds

### Command Mode

Global Configuration

### Example

```
Console(config)#ntp poll 60
Console(config)#
```

### Related Commands

- ntp client (4-62)

### ntp authenticate

This command enables authentication for NTP client-server communications. Use the **no** form to disable authentication.

### Syntax

```
[no] ntp authenticate
```

### Default Setting

Disabled

### Command Mode

Global Configuration

## Command Usage

You can enable NTP authentication to ensure that reliable updates are received from only authorized NTP servers. The authentication keys and their associated key number must be centrally managed and manually distributed to NTP servers and clients. The key numbers and key values must match on both the server and client.

## Example

```
Console(config)#ntp authenticate
Console(config)#
```

## Related Commands

ntp authentication-key (4-65)

## ntp authentication-key

This command configures key numbers and corresponding authentication keys to use when NTP authentication is enabled. Use the **no** form of the command to clear a specific authentication key or all keys from the current list.

## Syntax

```
ntp authentication-key number md5 key
no ntp authentication-key [number]
```

- *number* - The NTP authentication key ID number. (Range: 1-65535)
- **md5** - Specifies that authentication is provided by using the message digest algorithm 5.
- *key* - An MD5 authentication key string. The key string can be up to 32 case-sensitive printable ASCII characters (no spaces).

## Default Setting

None

## Command Mode

Global Configuration

## Command Usage

- The key number specifies a key value in the NTP authentication key list. Up to 255 keys can be configured on the switch. Re-enter this command for each key you want to configure.
- Note that NTP authentication key numbers and values must match on both the server and client.
- NTP authentication is optional. When enabled with the **ntp authenticate** command, you must also configure at least one key number using this command.
- Use the **no** form of this command without an argument to clear all authentication keys in the list.

### Example

```
Console(config)#ntp authentication-key 45 md5 thisiskey45
Console(config)#
```

### Related Commands

ntp authenticate (4-64)

### show ntp

This command displays the current time and configuration settings for the NTP client, and indicates whether or not the local time has been properly updated.

### Command Mode

Normal Exec, Privileged Exec

### Command Usage

This command displays the current time, the poll interval used for sending time synchronization requests, and the current NTP mode (i.e., unicast).

### Example

```
Console#show ntp
Current time: Jan 1 02:58:58 2001
Poll interval: 16
Current mode: unicast
NTP status : Enabled      NTP Authenticate status : Enabled
Last Update NTP Server: 0.0.0.0      Port: 0
Last Update time: Dec 31 00:00:00 2000 UTC
NTP Server 192.168.3.20 version 3
NTP Server 192.168.3.21 version 3
NTP Server 192.168.3.22 version 2
NTP Server 192.168.4.50 version 3 key 30
NTP Server 192.168.5.35 version 3 key 19
NTP Authentication-Key 12 md5 156S46Q24142414222711K66N80 7
NTP Authentication-Key 19 md5 Q33O16Q6338241J022S29Q731K7 7
NTP Authentication-Key 30 md5 D2V8777I51K1132K3552L26R614104 7
NTP Authentication-Key 45 md5 3U865531O13K38FOR8 7
NTP Authentication-Key 125 md5 A48S2810327947M76 7
Console#
```

## clock timezone-predefined

This command uses predefined time zone configurations to set the time zone for the switch's internal clock. Use the **no** form to restore the default.

### Syntax

**clock timezone-predefined** *offset-city*

**no clock timezone-predefined**

- *offset* - Select the offset from GMT. (Range: GMT-0100 - GMT-1200; GMT-Greenwich-Mean-Time; GMT+0100 - GMT+1400)
- *city* - Select the city associated with the chosen GMT offset. After the offset has been entered, use the tab-complete function to display the available city options.

### Default Setting

GMT-Greenwich-Mean-Time-Dublin,Edinburgh,Lisbon,London

### Command Mode

Global Configuration

### Command Usage

This command sets the local time zone relative to the Coordinated Universal Time (UTC, formerly Greenwich Mean Time or GMT), based on the earth's prime meridian, zero degrees longitude. To display a time corresponding to your local time, you must indicate the number of hours and minutes your time zone is east (before) or west (after) of UTC.

### Example

```
Console(config)#clock timezone-predefined GMT-0930-Taiohae
Console(config)#
```

### Related Commands

show snmp (4-62)

## clock timezone

This command sets the time zone for the switch's internal clock.

### Syntax

**clock timezone** *name* **hour** *hours* **minute** *minutes* {**before-utc** | **after-utc**}

- *name* - Name of timezone, usually an acronym. (Range: 1-29 characters)
- *hours* - Number of hours before/after UTC. (Range: 0-12 hours before; 0-13 hours after)
- *minutes* - Number of minutes before/after UTC. (Range: 0-59 minutes)
- **before-utc** - Sets the local time zone before (east) of UTC.
- **after-utc** - Sets the local time zone after (west) of UTC.

## Default Setting

None

## Command Mode

Global Configuration

## Command Usage

This command sets the local time zone relative to the Coordinated Universal Time (UTC, formerly Greenwich Mean Time or GMT), based on the earth's prime meridian, zero degrees longitude. To display a time corresponding to your local time, you must indicate the number of hours and minutes your time zone is east (before) or west (after) of UTC.

## Example

```
Console(config)#clock timezone Japan hours 8 minute 0 after-UTC
Console(config)#
```

## Related Commands

show snmp (4-62)

## clock summer-time (date)

This command sets the start, end, and offset times of summer-time (daylight savings time) for the switch on a one-time basis. Use the **no** form to disable summer-time.

## Syntax

**clock summer-time** *name date b-month b-day b-year b-hour b-minute  
e-month e-day e-year e-hour e-minute offset*  
**no clock summer-time**

- *name* - Name of the time zone while summer-time is in effect, usually an acronym. (Range: 1-30 characters)
- *b-month* - The month when summer-time will begin. (Options: **january** | **february** | **march** | **april** | **may** | **june** | **july** | **august** | **september** | **october** | **november** | **december**)
- *b-day* - The day summer-time will begin. (Options: **sunday** | **monday** | **tuesday** | **wednesday** | **thursday** | **friday** | **saturday**)
- *b-year* - The year summer-time will begin.
- *b-hour* - The hour summer-time will begin. (Range: 0-23 hours)
- *b-minute* - The minute summer-time will begin. (Range: 0-59 minutes)
- *e-month* - The month when summer-time will end. (Options: **january** | **february** | **march** | **april** | **may** | **june** | **july** | **august** | **september** | **october** | **november** | **december**)
- *e-day* - The day summer-time will end. (Options: **sunday** | **monday** | **tuesday** | **wednesday** | **thursday** | **friday** | **saturday**)
- *e-year* - The year summer-time will end.
- *e-hour* - The hour summer-time will end. (Range: 0-23 hours)

- *e-minute* - The minute summer-time will end. (Range: 0-59 minutes)
- *offset* - Summer-time offset from the regular time zone, in minutes. (Range: 0-99 minutes)

### Default Setting

Disabled

### Command Mode

Global Configuration

### Command Usage

- In some countries or regions, clocks are adjusted through the summer months so that afternoons have more daylight and mornings have less. This is known as Summer Time, or Daylight Savings Time (DST). Typically, clocks are adjusted forward one hour at the start of spring and then adjusted backward in autumn.
- This command sets the summer-time time zone relative to the currently configured time zone. To specify a time corresponding to your local time when summer-time is in effect, you must indicate the number of minutes your summer-time time zone deviates from your regular time zone.

### Example

```
Console(config)#clock summer-time DEST date april 1 2007 23 23 april 23
2007 23 23 60
Console(config)#
```

### Related Commands

show sntp (4-62)

### clock summer-time (predefined)

This command configures the summer time (daylight savings time) status and settings for the switch using predefined configurations for several major regions of the world. Use the **no** form to disable summer time.

### Syntax

**clock summer-time** *name* **predefined** [**australia** | **europe** | **new-zealand** | **usa**]

**no clock summer-time**

*name* - Name of the timezone while summer time is in effect, usually an acronym. (Range: 1-30 characters)

### Default Setting

Disabled

### Command Mode

Global Configuration

## Command Usage

- In some countries or regions, clocks are adjusted through the summer months so that afternoons have more daylight and mornings have less. This is known as Summer Time, or Daylight Savings Time (DST). Typically, clocks are adjusted forward one hour at the start of spring and then adjusted backward in autumn.
- This command sets the summer-time time relative to the configured time zone. To specify the time corresponding to your local time when summer-time is in effect, select the predefined summer-time time zone appropriate for your location, or manually configure summer-time if these predefined configurations do not apply to your location (see **clock summer-time** (date) on page 4-68 or **clock summer-time** (recurring) on page 4-70).

**Table 4-20 Predefined Summer-Time Parameters**

Region	Start Time, Day, Week, & Month	End Time, Day, Week, & Month	Rel. Offset
Australia	00:00:00, Sunday, Week 5 of October	23:59:59, Sunday, Week 5 of March	60 min
Europe	00:00:00, Sunday, Week 5 of March	23:59:59, Sunday, Week 5 of October	60 min
New Zealand	00:00:00, Sunday, Week 1 of October	23:59:59, Sunday, Week 3 of March	60 min
USA	02:00:00, Sunday, Week 2 of March	02:00:00, Sunday, Week 1 of November	60 min

## Example

```
Console(config)#clock summer-time MESZ predefined europe
Console(config)#
```

## Related Commands

show sntp (4-62)

## clock summer-time (recurring)

This command allows the user to manually configure the start, end, and offset times of summer-time (daylight savings time) for the switch on a recurring basis. Use the **no** form to disable summer-time.

## Syntax

**clock summer-time** *name* **recurring** *b-week b-day b-month b-hour b-minute e-week e-day e-month e-hour e-minute offset*

**no clock summer-time**

- *name* - Name of the timezone while summer time is in effect, usually an acronym. (Range: 1-30 characters)
- *b-week* - The week of the month when summer-time will begin. (Range: 1-5)
- *b-day* - The day of the week when summer-time will begin. (Options: **sunday** | **monday** | **tuesday** | **wednesday** | **thursday** | **friday** | **saturday**)
- *b-month* - The month when summer-time will begin. (Options: **january** | **february** | **march** | **april** | **may** | **june** | **july** | **august** | **september** | **october** | **november** | **december**)



- *b-hour* - The hour when summer-time will begin. (Range: 0-23 hours)
- *b-minute* - The minute when summer-time will begin. (Range: 0-59 minutes)
- *e-week* - The week of the month when summer-time will end. (Range: 1-5)
- *e-day* - The day of the week summer-time will end. (Options: **sunday** | **monday** | **tuesday** | **wednesday** | **thursday** | **friday** | **saturday**)
- *e-month* - The month when summer-time will end. (Options: **january** | **february** | **march** | **april** | **may** | **june** | **july** | **august** | **september** | **october** | **november** | **december**)
- *e-hour* - The hour when summer-time will end. (Range: 0-23 hours)
- *e-minute* - The minute when summer-time will end. (Range: 0-59 minutes)
- *offset* - Summer-time offset from the regular time zone, in minutes. (Range: 0-99 minutes)

### Default Setting

Disabled

### Command Mode

Global Configuration

### Command Usage

- In some countries or regions, clocks are adjusted through the summer months so that afternoons have more daylight and mornings have less. This is known as Summer Time, or Daylight Savings Time (DST). Typically, clocks are adjusted forward one hour at the start of spring and then adjusted backward in autumn.
- This command sets the summer-time time zone relative to the currently configured time zone. To specify a time corresponding to your local time when summer-time is in effect, you must indicate the number of minutes your summer-time time zone deviates from your regular time zone.

### Example

```
Console(config)#clock summer-time MESZ recurring 1 friday june 23 59 3
saturday september 2 55 60
Console(config)#
```

### Related Commands

show snmp (4-62)

### calendar set

This command sets the system clock. It may be used if there is no time server on your network, or if you have not configured the switch to receive signals from a time server.

### Syntax

**calendar set** *hour min sec {day month year | month day year}*

- *hour* - Hour in 24-hour format. (Range: 0-23)
- *min* - Minute. (Range: 0-59)
- *sec* - Second. (Range: 0-59)
- *day* - Day of month. (Range: 1-31)
- *month* - **january | february | march | april | may | june | july | august | september | october | november | december**
- *year* - Year (4-digit). (Range: 2001-2100)

### Default Setting

None

### Command Mode

Privileged Exec

### Example

```
Console#calendar set 15 12 34 1 April 2004
Console#
```

### show calendar

This command displays the system clock.

### Default Setting

None

### Command Mode

Normal Exec, Privileged Exec

### Example

```
Console#show calendar
15:12:43 April 1 2004
Console#
```

## Switch Cluster Commands

Switch Clustering is a method of grouping switches together to enable centralized management through a single unit. Switches that support clustering can be grouped together regardless of physical location or switch type, as long as they are connected to the same local network.

**Table 4-21 Switch Cluster Commands**

Command	Function	Mode	Page
cluster	Configures clustering on the switch	GC	4-73
cluster commander	Configures the switch as a cluster Commander	GC	4-74
cluster ip-pool	Sets the cluster IP address pool for Members	GC	4-75
cluster member	Sets Candidate switches as cluster members	GC	4-75
rcommand	Provides configuration access to Member switches	GC	4-76
show cluster	Displays the switch clustering status	PE	4-76
show cluster members	Displays current cluster Members	PE	4-77
show cluster candidates	Displays current cluster Candidates in the network	PE	4-77

### *Using Switch Clustering*

- A switch cluster has a primary unit called the “Commander” which is used to manage all other “Member” switches in the cluster. The management station uses both Telnet and the web interface to communicate directly with the Commander through its IP address, while the Commander manages Member switches using the cluster’s “internal” IP addresses.
- Once a switch has been configured to be a cluster Commander, it automatically discovers other cluster-enabled switches in the network. These “Candidate” switches only become cluster Members when manually selected by the administrator through the management station.

**Note:** Cluster Member switches can be managed either through a Telnet connection to the Commander, or through a web management connection to the Commander.

When using a console connection, from the Commander CLI prompt, use the **rcommand** (see page 4-76) to connect to the Member switch.

### **cluster**

This command enables clustering on the switch. Use the **no** form to disable clustering.

#### **Syntax**

[no] cluster

#### **Default Setting**

Enabled

#### **Command Mode**

Global Configuration

### Command Usage

- To create a switch cluster, first be sure that clustering is enabled on the switch (the default is enabled), then set the switch as a Cluster Commander. Set a Cluster IP Pool that does not conflict with any other IP subnets in the network. Cluster IP addresses are assigned to switches when they become Members and are used for communication between Member switches and the Commander.
- Switch clusters are limited to the same Ethernet broadcast domain.
- There can be up to 100 candidates and 36 member switches in one cluster.
- A switch can only be a Member of one cluster.
- Configured switch clusters are maintained across power resets and network changes.

### Example

```
Console(config)#cluster
Console(config)#
```

### cluster commander

This command enables the switch as a cluster Commander. Use the **no** form to disable the switch as cluster Commander.

### Syntax

[no] cluster commander

### Default Setting

Disabled

### Command Mode

Global Configuration

### Command Usage

- Once a switch has been configured to be a cluster Commander, it automatically discovers other cluster-enabled switches in the network. These “Candidate” switches only become cluster Members when manually selected by the administrator through the management station.
- Cluster Member switches can be managed through a Telnet connection to the Commander. From the Commander CLI prompt, use the **rcommand id** command to connect to the Member switch.

### Example

```
Console(config)#cluster commander
Console(config)#
```

## cluster ip-pool

This command sets the cluster IP address pool. Use the **no** form to reset to the default address.

### Syntax

**cluster ip-pool** *ip-address*

**no cluster ip-pool**

*ip-address* - The base IP address for IP addresses assigned to cluster Members. The IP address must start 10.x.x.x.

### Default Setting

10.254.254.1

### Command Mode

Global Configuration

### Command Usage

- An “internal” IP address pool is used to assign IP addresses to Member switches in the cluster. Internal cluster IP addresses are in the form 10.x.x.*member-ID*. Only the base IP address of the pool needs to be set since Member IDs can only be between 1 and 36.
- Set a Cluster IP Pool that does not conflict with addresses in the network IP subnet. Cluster IP addresses are assigned to switches when they become Members and are used for communication between Member switches and the Commander.
- You cannot change the cluster IP pool when the switch is currently in Commander mode. Commander mode must first be disabled.

### Example

```
Console(config)#cluster ip-pool 10.2.3.4
Console(config)#
```

## cluster member

This command configures a Candidate switch as a cluster Member. Use the **no** form to remove a Member switch from the cluster.

### Syntax

**cluster member mac-address** *mac-address id member-id*

**no cluster member id** *member-id*

- *mac-address* - The MAC address of the Candidate switch.
- *member-id* - The ID number to assign to the Member switch. (Range: 1-36)

### Default Setting

No Members

### Command Mode

Global Configuration

## 4 Command Line Interface

### Command Usage

- The maximum number of cluster Members is 36.
- The maximum number of switch Candidates is 100.

### Example

```
Console(config)#cluster member mac-address 00-12-34-56-78-9a id 5
Console(config)#
```

### rcommand

This command provides access to a cluster Member CLI for configuration.

### Syntax

**rcommand id** *member-id*

*member-id* - The ID number of the Member switch. (Range: 1-36)

### Command Mode

Privileged Exec

### Command Usage

- This command only operates through a Telnet connection to the Commander switch. Managing cluster Members using the local console CLI on the Commander is not supported.
- There is no need to enter the username and password for access to the Member switch CLI.

### Example

```
Vty-0#rcommand id 1

CLI session with the Ubigate iES4028F is opened.
To end the CLI session, enter [Exit].

Vty-0#
```

### show cluster

This command shows the switch clustering configuration.

### Command Mode

Privileged Exec

### Example

```
Console#show cluster
Role:                commander
Interval heartbeat:  30
Heartbeat loss count: 3
Number of Members:   1
Number of Candidates: 2
Console#
```

**show cluster members**

This command shows the current switch cluster members.

**Command Mode**

Privileged Exec

**Example**

```
Console#show cluster members
Cluster Members:
ID: 1
Role: Active member
IP Address: 10.254.254.2
MAC Address: 00-12-cf-23-49-c0
Description: Ubigate iES4028FP Switch
Console#
```

**show cluster candidates**

This command shows the discovered Candidate switches in the network.

**Command Mode**

Privileged Exec

**Example**

```
Console#show cluster candidates
Cluster Candidates:
Role           Mac              Description
-----
ACTIVE MEMBER  00-12-cf-23-49-c0 Ubigate iES4028FP Switch
CANDIDATE      00-12-cf-0b-47-a0 Ubigate iES4028FP Switch
Console#
```

**UPnP Commands**

Universal Plug and Play (UPnP) is a set of protocols that allows devices to connect seamlessly and simplifies the deployment of home and office networks. UPnP achieves this by issuing UPnP device control protocols designed upon open, Internet-based communication standards.

The commands described in this section allow the switch to advertise itself as a UPnP compliant device. When discovered by a host device, basic information about this switch can be displayed, and the web management interface accessed.

**Note:** UPnP is currently only supported by this switch for Windows Vista, but will be supported for Windows XP in future releases.

Table 4-1 UPnP Commands

Command	Function	Mode	Page
upnp device	Enables/disables UPnP on the network	GC	4-78
upnp device ttl	Sets the time-to-live (TTL) value.	GC	4-78
upnp device advertise duration	Sets the advertisement duration of the device	GC	4-79
show upnp	Displays UPnP status and parameters	PE	4-79

### upnp device

This command enables UPnP on the device. Use the **no** form to disable UPnP.

#### Syntax

**[no] upnp device**

#### Default Setting

Enabled

#### Command Mode

Global Configuration

#### Command Usage

You must enable UPnP before you can configure time out settings for sending of UPnP messages.

#### Example

In the following example, UPnP is enabled on the device.

```
Console(config)#upnp device
Console(config)#
```

#### Related Commands

upnp device ttl (4-78)

upnp device advertise duration (4-79)

### upnp device ttl

This command sets the time-to-live (TTL) value for sending of UPnP messages from the device.

#### Syntax

**upnp device ttl *value***

*value* - The number of router hops a UPnP packet can travel before it is discarded. (Range:1-255)

#### Default Setting

4

#### Command Mode

Global Configuration

#### Command Usage

UPnP devices and control points must be within the local network, that is within the TTL value for multicast messages.



## Example

In the following example, the TTL is set to 6.

```
Console(config)#upnp device ttl 6
Console(config)#
```

## upnp device advertise duration

This command sets the duration for which a device will advertise its presence on the local network.

### Syntax

**upnp device advertise duration** *value*

*value* - A time out value expressed in seconds. (Range: 6-86400 seconds)

### Default Setting

100 seconds

### Command Mode

Global Configuration

## Example

In the following example, the device advertise duration is set to 200 seconds.

```
Console(config)#upnp device advertise duration 200
Console(config)#
```

## Related Commands

upnp device ttl (4-78)

## show upnp

This command displays the UPnP management status and time out settings.

### Command Mode

Privileged Exec

## Example

```
Console#show upnp
UPnP global settings:
  Status:                Enabled
  Advertise duration:    200
  TTL:                   20
Console#
```

## Debug Commands

Table 4-22 Debug Commands

Command	Function	Mode	Page
debug dot1x	Configures debug settings for IEEE 802.1X	PE	4-80
debug radius	Configures debug settings for RADIUS	PE	4-82
debug tacacs	Configures debug settings for TACACS	PE	4-84

### debug dot1x

This command configures debug settings for IEEE 802.1X authentication processes. Use the **no** form to disable debug mode for IEEE 802.1X.

### Syntax

**[no] debug dot1x**

**[all | config | database | event | packet]**

**[show {all | state-machine [pae | backend]}]**

- **all** - Sets debugging for all options (config, database, event, packet).
- **config** - Sets debugging for dot1x configuration settings.
- **database** - Sets debugging for dot1x database operations.
- **event** - Sets debugging for dot1x events.
- **packet** - Sets debugging for dot1x packets.
- **show** - Displays information about the specified debug type.
  - **all** - Displays information for all options.
  - **state-machine** - Displays information on state-machine events.
  - **backend** - Displays information for backend state-machine events.
  - **pae** - Displays information for authenticator state-machine events.

### Default Setting

Disabled

### Command Mode

Privileged Exec

### Command Usage

- Use the **debug dot1x** command without any *classification* or *feature* to enable debugging for all 802.1X authentication processes.
- Use the **debug dot1x all** command to enable debugging for all of the *classification* options (i.e., config, database, event and packet).
- Use the **debug dot1x classification show feature** command to enable debugging for the specified classification and feature. When debugging is enabled for the **config** classification, debug messages will be shown when 802.1X configuration commands are entered. When debugging is enabled for the **database** classification, debug messages will be shown when a memory operation is applied to the 802.1X authentication database. When debugging is enabled for the **event** classification, debug messages will be shown when

an 802.1X system event occurs. When debugging is enabled for the **packet** classification, debug messages will be shown when the switch sends or receives an EAPOL packet.

- Use the **debug dot1x show state-machine** command to show debug messages for all state-machine related events.

### Example

```
Console#debug dot1x packet
Console#debug dot1x show packet
Console#
```

When the debug packet option is selected, messages similar to those shown below are displayed when an EAPOL packet is sent to a supplicant.

```
01:02:03: DOT1X: pkt: Sent an EAP packet, code=req, id=1, length=5,
type=identity, identity=lxuser
01:02:03: DOT1X: pkt: Sent an EAP packet, code=req, id=1, length=22,
type=md5, name=lxuser
01:02:03: DOT1X: pkt: Sent an EAP packet, code=succ, id=1, length=4
01:02:03: DOT1X: pkt: Sent an EAP packet, code=failure, id=1, length=4
```

When the debug packet option is selected, messages similar to those shown below are displayed when an EAPOL packet is received from a supplicant.

```
01:02:03: DOT1X: pkt: Received EAP packet, code=resp, id=1, length=10,
type=identity, identity=user1
01:02:03: DOT1X: pkt: Received EAP packet, code=resp, id=1, length=29,
type=md5
01:02:03: DOT1X: pkt: Received EAP packet, code=resp, id=1, length=6,
type=nak
01:02:03: DOT1X: pkt: Received EAPOL packet, ver=1, type=eapol-start
01:02:03: DOT1X: pkt: Received EAPOL packet, ver=1, type=eapol-logoff
```

When the debug state-machine option is selected, messages similar to those shown below are displayed when a change occurs in the state-machine.

```
01:02:03: DOT1X: event/pae-sm: State changing on port=1/1 from initialize
to disconnected
01:02:03: DOT1X: event/pae-sm: State changing on port=1/1 from disconnected
to connecting
01:02:03: DOT1X: event/pae-sm: State changing on port=1/1 from connecting
to timeout
01:02:03: DOT1X: event/pae-sm: State changing on port=1/1 from connecting
to authenticating
01:02:03: DOT1X: event/pae-sm: State changing on port=1/1 from timeout to
authenticated
01:02:03: DOT1X: event/pae-sm: State changing on port=1/1 from
authenticating to held
01:02:03: DOT1X: event/pae-sm: State changing on port=1/1 from
authenticating to aborting
01:02:03: DOT1X: event/bend-sm: State changing on port=1/1 from request to
response
01:02:03: DOT1X: event/bend-sm: State changing on port=1/1 from request to
timeout
01:02:03: DOT1X: event/bend-sm: State changing on port=1/1 from response to
fail
01:02:03: DOT1X: event/bend-sm: State changing on port=1/1 from response to
success
01:02:03: DOT1X: event/bend-sm: State changing on port=1/1 from success to
idle
```

### debug radius

This command configures debug settings for RADIUS processes. Use the **no** form to disable debug mode for RADIUS.

#### Syntax

##### [no] debug radius

[all | config | database | event | packet | avpair]

[show {all | accounting | authentication | authorization}]

- **all** - Sets debugging for all options (config, database, event, packet, avpair).
- **config** - Sets debugging for RADIUS configuration settings.
- **database** - Sets debugging for RADIUS database operations.
- **event** - Sets debugging for RADIUS events.
- **packet** - Sets debugging for RADIUS packets.
- **avpair** - Sets debugging for more detailed information on RADIUS packets.
- **show** - Displays information about the specified debug type.
  - **all** - Displays information for all options.
  - **accounting** - Displays information on accounting processes.
  - **authentication** - Displays information on authentication processes.
  - **authorization** - Displays information on authorization processes.

#### Default Setting

Disabled

## Command Mode

Privileged Exec

## Command Usage

- Use the **debug radius** command without any *classification* or *feature* to enable debugging for all RADIUS processes.
- Use the **debug radius all** command to enable debugging for all of the *classification* options (i.e., config, database, event, packet and avpair).
- Use the **debug radius classification show feature** command to enable debugging for the specified classification and feature. When debugging is enabled for the **config** classification, debug messages will be shown when RADIUS configuration commands are entered. When debugging is enabled for the **database** classification, debug messages will be shown when a memory operation is applied to the RADIUS database. When debugging is enabled for the **event** classification, debug messages will be shown when a RADIUS system event occurs. When debugging is enabled for the **packet** classification, debug messages will be shown when the switch sends or receives a RADIUS packet. When debugging is enabled for the **avpair** classification, detailed debug messages will be shown when the switch sends or receives a RADIUS packet.
- Use the **debug radius show** command to show debug messages for the selected process type.

## Example

```
Console#debug radius packet
Console#debug radius show packet
Console#
```

When the debug packet option is selected, messages similar to those shown below are displayed when a RADIUS request packet is sent.

```
01:02:03: RADIUS: pkt/authen/author: Sent a request packet,
code=access-req, id=10, length=53
01:02:03: RADIUS: avpair/authen/author: user-name=user1, password=***, nas
-ip-address=192.168.1.1, nas-identifier=
01:02:03 RADIUS: avpair/authen/author: user-name=1xuser, nas-port-id=1,
nas-port
-id=1, calling-station-id=00-D0-59-18-17-E2, eap-message=0201,
nas-ip-address=19
2.168.1.2, nas-identifier=, nas-port-type=15,
message-authenticator=3030303030...
01:02:03: RADIUS: pkt/acct: Sent a request packet, code=acct-req, id=10,
length=60
01:02:03: RADIUS: avpair/acct: user-name=user1,
nas-ip-address=192.168.1.1, nas-
port-type=15, acct-session-id=0, acct-status-yyype=1, acct-authentic=1,
acct-dela
y-time=1
01:02:03: RADIUS: avpair/acct: user-name=user1,
nas-ip-address=192.168.1.1, nas-
port-type=15, acct-session-id=0, acct-status-type=1, acct-authentic=1,
acct-dela
y-time=1, terminate-cause=1
```

When the debug packet option is selected, messages similar to those shown below are displayed when a RADIUS reply packet is received.

```
01:02:03: RADIUS: pkt/authen/author: Received a reply packet, code=accept,
id=10, length=56
01:02:03 RADIUS: pkt/authen/author: Received a reply packet,
code=access-chall, i
d=179, length=75
01:02:03 RADIUS: avpair/authen/author: state=5342522D43...,
eap-message=0102, me
ssage-authenticator=8615F23E8E...
01:02:03: RADIUS: avpair/authen/author: No attribute value pair
01:02:03: RADIUS: pkt/acct: Received a reply packet, code=acct-resp, id=10,
length=20
```

### debug tacacs

This command configures debug settings for TACACS processes. Use the **no** form to disable debug mode for TACACS.

#### Syntax

##### [no] debug tacacs

[all | config | database | event | packet | avpair]

[show {all | accounting | authentication | authorization}]

- **all** - Sets debugging for all options (config, database, event, packet, avpair).
- **config** - Sets debugging for TACACS configuration settings.
- **database** - Sets debugging for TACACS database operations.
- **event** - Sets debugging for TACACS events.
- **packet** - Sets debugging for RADIUS packets.
- **avpair** - Sets debugging for more detailed information on TACACS packets.
- **show** - Displays information about the specified debug type.
  - **all** - Displays information for all options.
  - **accounting** - Displays information on accounting processes.
  - **authentication** - Displays information on authentication processes.
  - **authorization** - Displays information on authorization processes.

#### Default Setting

Disabled

#### Command Mode

Privileged Exec

#### Command Usage

- Use the **debug tacacs** command without any *classification* or *feature* to enable debugging for all TACACS processes.
- Use the **debug radius all** command to enable debugging for all of the *classification* options (i.e., config, database, event, packet and avpair).
- Use the **debug tacacs classification show feature** command to enable debugging for the specified classification and feature. When debugging is enabled for the **config** classification, debug messages will be shown when

TACACS configuration commands are entered. When debugging is enabled for the **database** classification, debug messages will be shown when a memory operation is applied to the TACACS database. When debugging is enabled for the **event** classification, debug messages will be shown when a TACACS system event occurs. When debugging is enabled for the **packet** classification, debug messages will be shown when the switch sends or receives a TACACS packet. When debugging is enabled for the **avpair** classification, detailed debug messages will be shown when the switch sends or receives a TACACS packet.

- Use the **debug tacacs show** command to show debug messages for the selected process type.

### Example

```
Console#debug tacacs packet
Console#debug tacacs show packet
Console#
```

When the debug packet option is selected, messages similar to those shown below are displayed when a TACACS authentication start packet is sent.

```
01:02:03: TACACS+: pkt/authen: Sent a start packet, ver=12.0, type=authen,
seq_no=10, flag=clear, sess_id=20
01:02:03: TACACS+: avpair/authen: act=login, priv=15, type=ascii,
service=login, user=user1, port=tty10, addr=
01:02:03: TACACS+: avpair/authen: act=login, priv=15, type=,
service=enable, user=user1, port=tty10, addr=
```

When the debug packet option is selected, messages similar to those shown below are displayed when a TACACS authentication reply packet is received.

```
01:02:03: TACACS+: pkt/authen: Received a reply packet, reply status=pass
01:02:03: TACACS+: pkt/authen: Received a reply packet, reply status=fail
01:02:03: TACACS+: pkt/authen: Received a reply packet, reply
status=getdata
01:02:03: TACACS+: pkt/authen: Received a reply packet, reply
status=getuser
01:02:03: TACACS+: pkt/authen: Received a reply packet, reply
status=getpass
01:02:03: TACACS+: pkt/authen: Received a reply packet, reply
status=restart
01:02:03: TACACS+: pkt/authen: Received a reply packet, reply status=error
01:02:03: TACACS+: pkt/authen: Received a reply packet, reply status=follow
```

When the debug packet option is selected, messages similar to those shown below are displayed when a TACACS authentication cont (control) packet is sent.

```
01:02:03: TACACS+: pkt/authen: Sent a cont packet, ver=12.0, type=authen,
seq_no=10, flag=clear, sess_id=20
01:02:03: TACACS+: avpair/authen: user=***, data=
01:02:03: TACACS+: avpair/authen: user=***, data=
```

## SNMP Commands

Controls access to this switch from management stations using the Simple Network Management Protocol (SNMP), as well as the error types sent to trap managers.

SNMP Version 3 also provides security features that cover message integrity, authentication, and encryption; as well as controlling user access to specific areas of the MIB tree. To use SNMPv3, first set an SNMP engine ID (or accept the default), specify read and write access views for the MIB tree, configure SNMP user groups with the required security model (i.e., SNMP v1, v2c or v3) and security level (i.e., authentication and privacy), and then assign SNMP users to these groups, along with their specific authentication and privacy passwords.

**Table 4-23 SNMP Commands**

Command	Function	Mode	Page
snmp-server	Enables the SNMP agent	GC	4-86
show snmp	Displays the status of SNMP communications	NE, PE	4-87
snmp-server community	Sets up the community access string to permit access to SNMP commands	GC	4-88
snmp-server contact	Sets the system contact string	GC	4-88
snmp-server location	Sets the system location string	GC	4-89
snmp-server host	Specifies the recipient of an SNMP notification operation	GC	4-90
snmp-server enable traps	Enables the device to send SNMP traps (i.e., SNMP notifications)	GC	4-92
snmp-server engine-id	Sets the SNMPv3 engine ID	GC	4-93
show snmp engine-id	Shows the SNMPv3 engine ID	PE	4-94
snmp-server view	Adds an SNMPv3 view	GC	4-94
show snmp view	Shows the SNMPv3 views	PE	4-95
snmp-server group	Adds an SNMPv3 group, mapping users to views	GC	4-96
show snmp group	Shows the SNMPv3 groups	PE	4-97
snmp-server user	Adds a user to an SNMPv3 group	GC	4-98
show snmp user	Shows the SNMPv3 users	PE	4-99

### snmp-server

This command enables the SNMPv3 engine and services for all management clients (i.e., versions 1, 2c, 3). Use the **no** form to disable the server.

#### Syntax

[no] snmp-server

#### Default Setting

Enabled

#### Command Mode

Global Configuration



## Example

```
Console(config)#snmp-server
Console(config)#
```

## show snmp

This command can be used to check the status of SNMP communications.

## Default Setting

None

## Command Mode

Normal Exec, Privileged Exec

## Command Usage

This command provides information on the community access strings, counter information for SNMP input and output protocol data units, and whether or not SNMP logging has been enabled with the **snmp-server enable traps** command.

## Example

```
Console#show snmp
SNMP Agent: enabled

SNMP traps:
  Authentication: enable
  Link-up-down: enable

SNMP communities:
  1. private, and the privilege is read-write
  2. public, and the privilege is read-only

0 SNMP packets input
  0 Bad SNMP version errors
  0 Unknown community name
  0 Illegal operation for community name supplied
  0 Encoding errors
  0 Number of requested variables
  0 Number of altered variables
  0 Get-request PDUs
  0 Get-next PDUs
  0 Set-request PDUs
0 SNMP packets output
  0 Too big errors
  0 No such name errors
  0 Bad values errors
  0 General errors
  0 Response PDUs
  0 Trap PDUs

SNMP logging: disabled
Console#
```

### snmp-server community

This command defines the SNMP v1 and v2c community access string. Use the **no** form to remove the specified community string.

#### Syntax

**snmp-server community** *string* [ro|rw]  
**no snmp-server community** *string*

- *string* - Community string that acts like a password and permits access to the SNMP protocol. (Maximum length: 32 characters, case sensitive; Maximum number of strings: 5)
- **ro** - Specifies read-only access. Authorized management stations are only able to retrieve MIB objects.
- **rw** - Specifies read/write access. Authorized management stations are able to both retrieve and modify MIB objects.

#### Default Setting

- **public** - Read-only access. Authorized management stations are only able to retrieve MIB objects.
- **private** - Read/write access. Authorized management stations are able to both retrieve and modify MIB objects.

#### Command Mode

Global Configuration

#### Example

```
Console(config)#snmp-server community alpha rw
Console(config)#
```

### snmp-server contact

This command sets the system contact string. Use the **no** form to remove the system contact information.

#### Syntax

**snmp-server contact** *string*  
**no snmp-server contact**

*string* - String that describes the system contact information.  
(Maximum length: 255 characters)

#### Default Setting

None

#### Command Mode

Global Configuration

#### Example

```
Console(config)#snmp-server contact Paul
Console(config)#
```

**Related Commands**

snmp-server location (4-89)

**snmp-server location**

This command sets the system location string. Use the **no** form to remove the location string.

**Syntax**

**snmp-server location** *text*

**no snmp-server location**

*text* - String that describes the system location.

(Maximum length: 255 characters)

**Default Setting**

None

**Command Mode**

Global Configuration

**Example**

```
Console(config)#snmp-server location WC-19
Console(config)#
```

**Related Commands**

snmp-server contact (4-88)

### snmp-server host

This command specifies the recipient of a Simple Network Management Protocol notification operation. Use the **no** form to remove the specified host.

#### Syntax

```
snmp-server host host-addr [inform [retry retries | timeout seconds]]  
community-string [version {1 | 2c | 3 {auth | noauth | priv}] [udp-port port]]  
no snmp-server host host-addr
```

- *host-addr* - Internet address of the host (the targeted recipient). (Maximum host addresses: 5 trap destination IP address entries)
- **inform** - Notifications are sent as inform messages. Note that this option is only available for version 2c and 3 hosts. (Default: traps are used)
  - *retries* - The maximum number of times to resend an inform message if the recipient does not acknowledge receipt. (Range: 0-255; Default: 3)
  - *seconds* - The number of seconds to wait for an acknowledgment before resending an inform message. (Range: 0-2147483647 centiseconds; Default: 1500 centiseconds)
- *community-string* - Password-like community string sent with the notification operation to SNMP V1 and V2c hosts. Although you can set this string using the **snmp-server host** command by itself, we recommend that you define this string using the **snmp-server community** command prior to using the **snmp-server host** command. (Maximum length: 32 characters)
- **version** - Specifies whether to send notifications as SNMP Version 1, 2c or 3 traps. (Range: 1, 2c, 3; Default: 1)
  - **auth** | **noauth** | **priv** - This group uses SNMPv3 with authentication, no authentication, or with authentication and privacy. See “Simple Network Management Protocol” on page 3-40 for further information about these authentication and encryption options.
- *port* - Host UDP port to use. (Range: 1-65535; Default: 162)

#### Default Setting

- Host Address: None
- Notification Type: Traps
- SNMP Version: 1
- UDP Port: 162

#### Command Mode

Global Configuration

#### Command Usage

- If you do not enter an **snmp-server host** command, no notifications are sent. In order to configure the switch to send SNMP notifications, you must enter at least one **snmp-server host** command. In order to enable multiple hosts, you must issue a separate **snmp-server host** command for each host.
- The **snmp-server host** command is used in conjunction with the **snmp-server enable traps** command. Use the **snmp-server enable traps**

command to enable the sending of traps or informs and to specify which SNMP notifications are sent globally. For a host to receive notifications, at least one **snmp-server enable traps** command and the **snmp-server host** command for that host must be enabled.

- Some notification types cannot be controlled with the **snmp-server enable traps** command. For example, some notification types are always enabled.
- Notifications are issued by the switch as trap messages by default. The recipient of a trap message does not send a response to the switch. Traps are therefore not as reliable as inform messages, which include a request for acknowledgement of receipt. Informs can be used to ensure that critical information is received by the host. However, note that informs consume more system resources because they must be kept in memory until a response is received. Informs also add to network traffic. You should consider these effects when deciding whether to issue notifications as traps or informs.

To send an inform to a SNMPv2c host, complete these steps:

1. Enable the SNMP agent (page 4-86).
2. Allow the switch to send SNMP traps; i.e., notifications (page 4-92).
3. Specify the target host that will receive inform messages with the **snmp-server host** command as described in this section.
4. Create a view with the required notification messages (page 4-94).
5. Create a group that includes the required notify view (page 4-96).

To send an inform to a SNMPv3 host, complete these steps:

1. Enable the SNMP agent (page 4-86).
  2. Allow the switch to send SNMP traps; i.e., notifications (page 4-92).
  3. Specify the target host that will receive inform messages with the **snmp-server host** command as described in this section.
  4. Create a view with the required notification messages (page 4-94).
  5. Create a group that includes the required notify view (page 4-96).
  6. Specify a remote engine ID where the user resides (page 4-93).
  7. Then configure a remote user (page 4-98).
- The switch can send SNMP Version 1, 2c or 3 notifications to a host IP address, depending on the SNMP version that the management station supports. If the **snmp-server host** command does not specify the SNMP version, the default is to send SNMP version 1 notifications.
  - If you specify an SNMP Version 3 host, then the community string is interpreted as an SNMP user name. If you use the V3 “auth” or “priv” options, the user name must first be defined with the **snmp-server user** command. Otherwise, the authentication password and/or privacy password will not exist, and the switch will not authorize SNMP access for the host. However, if you specify a V3 host with the “noauth” option, an SNMP user account will be generated, and the switch will authorize SNMP access for the host.

### Example

```
Console(config)#snmp-server host 10.1.19.23 batman
Console(config)#
```

## Related Commands

snmp-server enable traps (4-92)

## snmp-server enable traps

This command enables this device to send Simple Network Management Protocol traps or informs (i.e., SNMP notifications). Use the **no** form to disable SNMP notifications.

## Syntax

[no] **snmp-server enable traps** [authentication | link-up-down]

- **authentication** - Keyword to issue authentication failure notifications.
- **link-up-down** - Keyword to issue link-up or link-down notifications.

## Default Setting

Issue authentication and link-up-down traps.

## Command Mode

Global Configuration

## Command Usage

- If you do not enter an **snmp-server enable traps** command, no notifications controlled by this command are sent. In order to configure this device to send SNMP notifications, you must enter at least one **snmp-server enable traps** command. If you enter the command with no keywords, both authentication and link-up-down notifications are enabled. If you enter the command with a keyword, only the notification type related to that keyword is enabled.
- The **snmp-server enable traps** command is used in conjunction with the **snmp-server host** command. Use the **snmp-server host** command to specify which host or hosts receive SNMP notifications. In order to send notifications, you must configure at least one **snmp-server host** command.
- The authentication, link-up, and link-down traps are legacy notifications, and therefore when used for SNMP Version 3 hosts, they must be enabled in conjunction with the corresponding entries in the Notify View assigned by the **snmp-server group** command (page 4-96).

## Example

```
Console(config)#snmp-server enable traps link-up-down
Console(config)#
```

## Related Commands

snmp-server host (4-90)

## snmp-server engine-id

This command configures an identification string for the SNMPv3 engine. Use the **no** form to restore the default.

### Syntax

```
snmp-server engine-id {local | remote {ip-address}} engineid-string  
no snmp-server engine-id {local | remote {ip-address}}
```

- **local** - Specifies the SNMP engine on this switch.
- **remote** - Specifies an SNMP engine on a remote device.
- *ip-address* - The Internet address of the remote device.
- *engineid-string* - String identifying the engine ID.  
(Range: 10-64 hexadecimal characters representing 5-32 octets)

### Default Setting

A unique engine ID is automatically generated by the switch based on its MAC address.

### Command Mode

Global Configuration

### Command Usage

- An SNMP engine is an independent SNMP agent that resides either on this switch or on a remote device. This engine protects against message replay, delay, and redirection. The engine ID is also used in combination with user passwords to generate the security keys for authenticating and encrypting SNMPv3 packets.
- A remote engine ID is required when using SNMPv3 informs. (See **snmp-server host** on page 4-90.) The remote engine ID is used to compute the security digest for authenticating and encrypting packets sent to a user on the remote host. SNMP passwords are localized using the engine ID of the authoritative agent. For informs, the authoritative SNMP agent is the remote agent. You therefore need to configure the remote agent's SNMP engine ID before you can send proxy requests or informs to it.
- Trailing zeroes need not be entered to uniquely specify a engine ID. In other words, the value "123456789" is equivalent to "1234567890" because a trailing zero will be added to fill in the last octet if an odd number of hexadecimal characters is specified.
- A local engine ID is automatically generated that is unique to the switch. This is referred to as the default engine ID. If the local engine ID is deleted or changed, all SNMP users will be cleared. You will need to reconfigure all existing users (page 4-98).

### Example

```
Console(config)#snmp-server engine-id local 123456789  
Console(config)#snmp-server engineID remote 987654321 192.168.1.19  
Console(config)#
```

## Related Commands

snmp-server host (4-90)

## show snmp engine-id

This command shows the SNMP engine ID.

## Command Mode

Privileged Exec

## Example

This example shows the default engine ID.

```
Console#show snmp engine-id
Local SNMP engineID: 8000002a8000000000e8666672
Local SNMP engineBoots: 1

Remote SNMP engineID                               IP address
80000000030004e2b316c54321                         192.168.1.19
Console#
```

Table 4-24 show snmp engine-id - display description

Field	Description
Local SNMP engineID	String identifying the engine ID.
Local SNMP engineBoots	The number of times that the engine has (re-)initialized since the snmp EngineID was last configured.
Remote SNMP engineID	String identifying an engine ID on a remote device.
IP address	IP address of the device containing the corresponding remote SNMP engine.

## snmp-server view

This command adds an SNMP view which controls user access to the MIB. Use the **no** form to remove an SNMP view.

## Syntax

**snmp-server view** *view-name oid-tree* {**included** | **excluded**}

**no snmp-server view** *view-name*

- *view-name* - Name of an SNMP view. (Range: 1-64 characters)
- *oid-tree* - Object identifier of a branch within the MIB tree. Wild cards can be used to mask a specific portion of the OID string. (Refer to the examples.)
- **included** - Defines an included view.
- **excluded** - Defines an excluded view.

## Default Setting

defaultview (includes access to the entire MIB tree)

## Command Mode

Global Configuration



## Command Usage

- Views are used in the **snmp-server group** command to restrict user access to specified portions of the MIB tree.
- The predefined view “defaultview” includes access to the entire MIB tree.

## Examples

This view includes MIB-2.

```
Console(config)#snmp-server view mib-2 1.3.6.1.2.1 included
Console(config)#
```

This view includes the MIB-2 interfaces table, ifDescr. The wild card is used to select all the index values in this table.

```
Console(config)#snmp-server view ifEntry.2 1.3.6.1.2.1.2.2.1.*.2 included
Console(config)#
```

This view includes the MIB-2 interfaces table, and the mask selects all index entries.

```
Console(config)#snmp-server view ifEntry.a 1.3.6.1.2.1.2.2.1.1.* included
Console(config)#
```

## show snmp view

This command shows information on the SNMP views.

## Command Mode

Privileged Exec

## Example

```
Console#show snmp view
View Name: mib-2
Subtree OID: 1.2.2.3.6.2.1
View Type: included
Storage Type: permanent
Row Status: active

View Name: defaultview
Subtree OID: 1
View Type: included
Storage Type: volatile
Row Status: active

Console#
```

**Table 4-25 show snmp view - display description**

Field	Description
View Name	Name of an SNMP view.
Subtree OID	A branch in the MIB tree.
View Type	Indicates if the view is included or excluded.
Storage Type	The storage type for this entry.
Row Status	The row status of this entry.

### snmp-server group

This command adds an SNMP group, mapping SNMP users to SNMP views. Use the **no** form to remove an SNMP group.

#### Syntax

```
snmp-server group groupname {v1 | v2c | v3 {auth | noauth | priv}}  
[read readview] [write writeview] [notify notifyview]  
no snmp-server group groupname
```

- *groupname* - Name of an SNMP group. (Range: 1-32 characters)
- **v1** | **v2c** | **v3** - Use SNMP version 1, 2c or 3.
- **auth** | **noauth** | **priv** - This group uses SNMPv3 with authentication, no authentication, or with authentication and privacy. See “Simple Network Management Protocol” on page 3-40 for further information about these authentication and encryption options.
- *readview* - Defines the view for read access. (1-64 characters)
- *writeview* - Defines the view for write access. (1-64 characters)
- *notifyview* - Defines the view for notifications. (1-64 characters)

#### Default Setting

- Default groups: *public*<sup>23</sup> (read only), *private*<sup>24</sup> (read/write)
- *readview* - Every object belonging to the Internet OID space (1.3.6.1).
- *writeview* - Nothing is defined.
- *notifyview* - Nothing is defined.

#### Command Mode

Global Configuration

#### Command Usage

- A group sets the access policy for the assigned users.
- When authentication is selected, the MD5 or SHA algorithm is used as specified in the **snmp-server user** command.
- When privacy is selected, the DES 56-bit algorithm is used for data encryption.
- Note that the authentication, link-up and link-down messages are legacy traps and must therefore be enabled in conjunction with the **snmp-server enable traps** command (page 4-92).

#### Example

```
Console(config)#snmp-server group r&d v3 auth write daily  
Console(config)#
```

---

23. No view is defined.

24. Maps to the defaultview.

## show snmp group

Four default groups are provided – SNMPv1 read-only access and read/write access, and SNMPv2c read-only access and read/write access.

### Command Mode

Privileged Exec

### Example

```
Console#show snmp group
Group Name: r&d
Security Model: v3
Read View: defaultview
Write View: daily
Notify View: none
Storage Type: permanent
Row Status: active

Group Name: public
Security Model: v1
Read View: defaultview
Write View: none
Notify View: none
Storage Type: volatile
Row Status: active

Group Name: public
Security Model: v2c
Read View: defaultview
Write View: none
Notify View: none
Storage Type: volatile
Row Status: active

Group Name: private
Security Model: v1
Read View: defaultview
Write View: defaultview
Notify View: none
Storage Type: volatile
Row Status: active

Group Name: private
Security Model: v2c
Read View: defaultview
Write View: defaultview
Notify View: none
Storage Type: volatile
Row Status: active
Console#
```

**Table 4-26 show snmp group - display description**

Field	Description
groupname	Name of an SNMP group.
security model	The SNMP version.
readview	The associated read view.
writeview	The associated write view.
notifyview	The associated notify view.
storage-type	The storage type for this entry.
Row Status	The row status of this entry.

## snmp-server user

This command adds a user to an SNMP group, restricting the user to a specific SNMP Read, Write, or Notify View. Use the **no** form to remove a user from an SNMP group.

### Syntax

```
snmp-server user username groupname [remote ip-address] {v1 | v2c | v3
[encrypted] [auth {md5 | sha} auth-password [priv des56 priv-password]}
no snmp-server user username {v1 | v2c | v3 | remote}
```

- *username* - Name of user connecting to the SNMP agent.  
(Range: 1-32 characters)
- *groupname* - Name of an SNMP group to which the user is assigned.  
(Range: 1-32 characters)
- **remote** - Specifies an SNMP engine on a remote device.
- *ip-address* - The Internet address of the remote device.
- **v1** | **v2c** | **v3** - Use SNMP version 1, 2c or 3.
- **encrypted** - Accepts the password as encrypted input.
- **auth** - Uses SNMPv3 with authentication.
- **md5** | **sha** - Uses MD5 or SHA authentication.
- *auth-password* - Authentication password. Enter as plain text if the **encrypted** option is not used. Otherwise, enter an encrypted password. (A minimum of eight characters is required.)
- **priv des56** - Uses SNMPv3 with privacy with DES56 encryption.
- *priv-password* - Privacy password. Enter as plain text if the **encrypted** option is not used. Otherwise, enter an encrypted password.

### Default Setting

None

### Command Mode

Global Configuration

## Command Usage

- The SNMP engine ID is used to compute the authentication/privacy digests from the password. You should therefore configure the engine ID with the **snmp-server engine-id** command before using this configuration command.
- Before you configure a remote user, use the **snmp-server engine-id** command (page 4-93) to specify the engine ID for the remote device where the user resides. Then use the **snmp-server user** command to specify the user and the IP address for the remote device where the user resides. The remote agent's SNMP engine ID is used to compute authentication/privacy digests from the user's password. If the remote engine ID is not first configured, the **snmp-server user** command specifying a remote user will fail.
- SNMP passwords are localized using the engine ID of the authoritative agent. For informs, the authoritative SNMP agent is the remote agent. You therefore need to configure the remote agent's SNMP engine ID before you can send proxy requests or informs to it.

## Example

```
Console(config)#snmp-server user steve group r&d v3 auth md5 greenpeace
priv des56 einstien
Console(config)#snmp-server user mark group r&d remote 192.168.1.19 v3
auth md5 greenpeace priv des56 einstien
Console(config)#
```

## show snmp user

This command shows information on SNMP users.

## Command Mode

Privileged Exec

## Example

```
Console#show snmp user
EngineId: 800000ca030030f1df9ca00000
User Name: steve
Authentication Protocol: md5
Privacy Protocol: des56
Storage Type: nonvolatile
Row Status: active

SNMP remote user
EngineId: 80000000030004e2b316c54321
User Name: mark
Authentication Protocol: mdt
Privacy Protocol: des56
Storage Type: nonvolatile
Row Status: active

Console#
```

**Table 4-27 show snmp user - display description**

Field	Description
Engineld	String identifying the engine ID.
User Name	Name of user connecting to the SNMP agent.
Authentication Protocol	The authentication protocol used with SNMPv3.
Privacy Protocol	The privacy protocol used with SNMPv3.
Storage Type	The storage type for this entry.
Row Status	The row status of this entry.
SNMP remote user	A user associated with an SNMP engine on a remote device.

## Authentication Commands

You can configure this switch to authenticate users logging into the system for management access using local or RADIUS authentication methods. You can also enable port-based authentication for network client access using IEEE 802.1X.

**Table 4-28 Authentication Commands**

Command Group	Function	Page
User Accounts	Configures the basic user names and passwords for management access	4-100
Authentication Sequence	Defines logon authentication method and precedence	4-103
RADIUS Client	Configures settings for authentication via a RADIUS server	4-105
TACACS+ Client	Configures settings for authentication via a TACACS+ server	4-109
AAA	Configures authentication, authorization, and accounting for network access	4-114
Web Server	Enables management access via a web browser	4-123
Telnet Server	Enables management access via Telnet	4-126
Secure Shell	Provides secure replacement for Telnet	4-127
Port Authentication	Configures host authentication on specific ports using 802.1X	4-136
Management IP Filter	Configures IP addresses that are allowed management access	4-145

## User Account Commands

The basic commands required for management access are listed in this section. This switch also includes other options for password checking via the console or a Telnet connection (page 4-40), user authentication via a remote authentication server (page 4-100), and host access authentication for specific ports (page 4-136).

**Table 4-29 User Access Commands**

Command	Function	Mode	Page
username	Establishes a user name-based authentication system at login	GC	4-101
enable password	Sets a password to control access to the Privileged Exec level	GC	4-102

## username

This command adds named users, requires authentication at login, specifies or changes a user's password (or specify that no password is required), or specifies or changes a user's access level. Use the **no** form to remove a user name.

### Syntax

```
username name {access-level level | nopassword |
password {0 | 7} password}
no username name
```

- ***name*** - The name of the user.  
(Maximum length: 8 characters, case sensitive. Maximum users: 16)
- **access-level *level*** - Specifies the user level.  
The device has two predefined privilege levels:  
**0**: Normal Exec, **15**: Privileged Exec.
- **nopassword** - No password is required for this user to log in.
- **{0 | 7}** - 0 means plain password, 7 means encrypted password.
- **password *password*** - The authentication password for the user.  
(Maximum length: 8 characters plain text, 32 encrypted, case sensitive)

### Default Setting

- The default access level is Normal Exec.
- The factory defaults for the user names and passwords are:

Table 4-30 Default Login Settings

username	access-level	password
guest	0	guest
admin	15	admin

### Command Mode

Global Configuration

### Command Usage

The encrypted password is required for compatibility with legacy password settings (i.e., plain text or encrypted) when reading the configuration file during system bootup or when downloading the configuration file from a TFTP server. There is no need for you to manually configure encrypted passwords.

### Example

This example shows how to set the access level and password for a user.

```
Console(config)#username bob access-level 15
Console(config)#username bob password 0 smith
Console(config)#
```

### enable password

After initially logging onto the system, you should set the Privileged Exec password. Remember to record it in a safe place. This command controls access to the Privileged Exec level from the Normal Exec level. Use the **no** form to reset the default password.

### Syntax

**enable password** [*level level*] {**0** | **7**} *password*

**no enable password** [*level level*]

- **level level** - Level 15 for Privileged Exec. (Levels 0-14 are not used.)
- {**0** | **7**} - 0 means plain password, 7 means encrypted password.
- *password* - password for this privilege level.  
(Maximum length: 8 characters plain text, 32 encrypted, case sensitive)

### Default Setting

- The default is level 15.
- The default password is "super"

### Command Mode

Global Configuration

### Command Usage

- You cannot set a null password. You will have to enter a password to change the command mode from Normal Exec to Privileged Exec with the **enable** command (page 4-11).
- The encrypted password is required for compatibility with legacy password settings (i.e., plain text or encrypted) when reading the configuration file during system bootup or when downloading the configuration file from a TFTP server. There is no need for you to manually configure encrypted passwords.

### Example

```
Console(config)#enable password level 15 0 admin
Console(config)#
```

### Related Commands

enable (4-11)  
authentication enable (4-104)



## Authentication Sequence

Three authentication methods can be specified to authenticate users logging into the system for management access. The commands in this section can be used to define the authentication method and sequence.

Table 4-31 Authentication Sequence

Command	Function	Mode	Page
authentication login	Defines logon authentication method and precedence	GC	4-103
authentication enable	Defines the authentication method and precedence for command mode change	GC	4-104

### authentication login

This command defines the login authentication method and precedence. Use the **no** form to restore the default.

#### Syntax

**authentication login** {[local] [radius] [tacacs]}  
**no authentication login**

- **local** - Use local password.
- **radius** - Use RADIUS server password.
- **tacacs** - Use TACACS server password.

#### Default Setting

Local

#### Command Mode

Global Configuration

#### Command Usage

- RADIUS uses UDP while TACACS+ uses TCP. UDP only offers best effort delivery, while TCP offers a connection-oriented transport. Also, note that RADIUS encrypts only the password in the access-request packet from the client to the server, while TACACS+ encrypts the entire body of the packet.
- RADIUS and TACACS+ logon authentication assigns a specific privilege level for each user name and password pair. The user name, password, and privilege level must be configured on the authentication server.
- You can specify three authentication methods in a single command to indicate the authentication sequence. For example, if you enter "**authentication login radius tacacs local**," the user name and password on the RADIUS server is verified first. If the RADIUS server is not available, then authentication is attempted on the TACACS+ server. If the TACACS+ server is not available, the local user name and password is checked.

#### Example

```
Console(config)#authentication login radius
Console(config)#
```

### Related Commands

username - for setting the local user names and passwords (4-101)

### authentication enable

This command defines the authentication method and precedence to use when changing from Exec command mode to Privileged Exec command mode with the **enable** command (see page 4-11). Use the **no** form to restore the default.

### Syntax

**authentication enable** {[local] [radius] [tacacs]}  
**no authentication enable**

- **local** - Use local password only.
- **radius** - Use RADIUS server password only.
- **tacacs** - Use TACACS server password.

### Default Setting

Local

### Command Mode

Global Configuration

### Command Usage

- RADIUS uses UDP while TACACS+ uses TCP. UDP only offers best effort delivery, while TCP offers a connection-oriented transport. Also, note that RADIUS encrypts only the password in the access-request packet from the client to the server, while TACACS+ encrypts the entire body of the packet.
- RADIUS and TACACS+ logon authentication assigns a specific privilege level for each user name and password pair. The user name, password, and privilege level must be configured on the authentication server.
- You can specify three authentication methods in a single command to indicate the authentication sequence. For example, if you enter "**authentication enable radius tacacs local**," the user name and password on the RADIUS server is verified first. If the RADIUS server is not available, then authentication is attempted on the TACACS+ server. If the TACACS+ server is not available, the local user name and password is checked.

### Example

```
Console(config)#authentication enable radius
Console(config)#
```

### Related Commands

enable password - sets the password for changing command modes (4-102)

## RADIUS Client

Remote Authentication Dial-in User Service (RADIUS) is a logon authentication protocol that uses software running on a central server to control access to RADIUS-aware devices on the network. An authentication server contains a database of multiple user name/password pairs with associated privilege levels for each user or group that require management access to a switch.

Table 4-32 RADIUS Client Commands

Command	Function	Mode	Page
radius-server host	Specifies the RADIUS server	GC	4-105
radius-server auth-port	Sets the RADIUS server network port	GC	4-106
radius-server acct-port	Sets the RADIUS server network port	GC	4-106
radius-server attribute 4	Sets the RADIUS NAS IP address	GC	4-107
radius-server key	Sets the RADIUS encryption key	GC	4-107
radius-server retransmit	Sets the number of retries	GC	4-108
radius-server timeout	Sets the interval between sending authentication requests	GC	4-108
show radius-server	Shows the current RADIUS settings	PE	4-109

### radius-server host

This command specifies primary and backup RADIUS servers and authentication parameters that apply to each server. Use the **no** form to restore the default values.

#### Syntax

```
[no] radius-server index host {host_ip_address} [auth-port auth_port]
[acct-port acct_port] [timeout timeout] [retransmit retransmit] [key key]
```

- *index* - Allows you to specify up to five servers. These servers are queried in sequence until a server responds or the retransmit period expires.
- *host\_ip\_address* - IP address of server.
- *auth\_port* - RADIUS server UDP port used for authentication messages. (Range: 1-65535)
- *acct\_port* - RADIUS server UDP port used for accounting messages. (Range: 1-65535)
- *timeout* - Number of seconds the switch waits for a reply before resending a request. (Range: 1-65535)
- *retransmit* - Number of times the switch will try to authenticate logon access via the RADIUS server. (Range: 1-30)
- *key* - Encryption key used to authenticate logon access for client. Do not use blank spaces in the string. (Maximum length: 26 characters)

#### Default Setting

- **auth-port** - 1812
- **acct-port** - 1813
- **timeout** - 5 seconds
- **retransmit** - 2

## 4 Command Line Interface

### Command Mode

Global Configuration

### Example

```
Console(config)#radius-server 1 host 192.168.1.20 auth-port 181 timeout  
10 retransmit 5 key green  
Console(config)#
```

### radius-server auth-port

This command sets the RADIUS server network port for authentication messages. Use the **no** form to restore the default.

### Syntax

**radius-server auth-port** *port\_number*  
**no radius-server auth-port**

*port\_number* - RADIUS server UDP port used for authentication messages. (Range: 1-65535)

### Default Setting

1812

### Command Mode

Global Configuration

### Example

```
Console(config)#radius-server port 181  
Console(config)#
```

### radius-server acct-port

This command sets the RADIUS server network port for accounting messages. Use the **no** form to restore the default.

### Syntax

**radius-server acct-port** *port\_number*  
**no radius-server acct-port**

*port\_number* - RADIUS server UDP port used for accounting messages. (Range: 1-65535)

### Default Setting

1813

### Command Mode

Global Configuration

### Example

```
Console(config)#radius-server acct-port 181  
Console(config)#
```

### radius-server attribute 4

This command sets the IP address of the Network Access Server (NAS) to use in the attribute 4 address field in packets sent to the RADIUS server. Use the **no** form to restore the default setting.

#### Syntax

```
radius-server attribute 4 nas_ip_address  
no radius-server attribute 4
```

*nas\_ip\_address* - The IP address of the NAS.

#### Default Setting

The IP address of the interface that connects the switch to the RADIUS server.

#### Command Mode

Global Configuration

#### Command Usage

- The IP address of the interface connecting the switch (i.e., the NAS) to the RADIUS server is used in the IP headers of RADIUS packets sent to the server. This address is also used by default in the attribute 4 field inside of RADIUS packets sent to the server.
- It may be necessary for certain AAA processes to configure the attribute 4 field to an address other than that of the switch's connecting interface. However, setting this field to an address other than that of the actual interface connecting the switch to the RADIUS server will not affect the IP address used inside the IP headers of RADIUS packets sent from the switch.
- Some AAA clients may try to change the attribute 4 address. Using the **radius-server attribute 4** command prevents these clients from changing this address.

#### Example

```
Console(config)#radius-server attribute 4 192.168.1.1  
Console(config)#
```

### radius-server key

This command sets the RADIUS encryption key. Use the **no** form to restore the default.

#### Syntax

```
radius-server key key_string  
no radius-server key
```

*key\_string* - Encryption key used to authenticate logon access for client.  
Do not use blank spaces in the string. (Maximum length: 48 characters)

#### Default Setting

None

## 4 Command Line Interface

### Command Mode

Global Configuration

### Example

```
Console(config)#radius-server key green
Console(config)#
```

### radius-server retransmit

This command sets the number of retries. Use the **no** form to restore the default.

### Syntax

**radius-server retransmit** *number\_of\_retries*

**no radius-server retransmit**

*number\_of\_retries* - Number of times the switch will try to authenticate logon access via the RADIUS server. (Range: 1-30)

### Default Setting

2

### Command Mode

Global Configuration

### Example

```
Console(config)#radius-server retransmit 5
Console(config)#
```

### radius-server timeout

This command sets the interval between transmitting authentication requests to the RADIUS server. Use the **no** form to restore the default.

### Syntax

**radius-server timeout** *number\_of\_seconds*

**no radius-server timeout**

*number\_of\_seconds* - Number of seconds the switch waits for a reply before resending a request. (Range: 1-65535)

### Default Setting

5

### Command Mode

Global Configuration

### Example

```
Console(config)#radius-server timeout 10
Console(config)#
```

**show radius-server**

This command displays the current settings for the RADIUS server.

**Default Setting**

None

**Command Mode**

Privileged Exec

**Example**

```

Console#show radius-server

Remote RADIUS Server Configuration:

Global Settings:
  Authentication Port : 1812
  Accounting Port    : 1813
  Retransmit Times   : 2
  Request Timeout    : 5 seconds

Attributes:
  NAS-IP-Address (4) : 192.168.1.1

Server 1:
  Server IP Address  : 10.1.2.3
  Authentication Port : 1812
  Accounting Port    : 1813
  Retransmit Times   : 2
  Request Timeout    : 5 seconds

Radius server group:
  Group Name          Member Index
  -----
  radius              1
Console#

```

**TACACS+ Client**

Terminal Access Controller Access Control System (TACACS+) is a logon authentication protocol that uses software running on a central server to control access to TACACS-aware devices on the network. An authentication server contains a database of multiple user name/password pairs with associated privilege levels for each user or group that require management access to a switch.

**Table 4-33 TACACS Commands**

Command	Function	Mode	Page
tacacs-server host	Specifies the TACACS+ server	GC	4-110
tacacs-server port	Specifies the TACACS+ server network port	GC	4-110
tacacs-server key	Sets the TACACS+ encryption key	GC	4-111
tacacs-server retransmit	Sets the number of retries	GC	4-111
tacacs-server timeout	Sets the interval before resending an authentication request	GC	4-112
show tacacs-server	Shows the current TACACS+ settings	GC	4-113

### **tacacs-server host**

This command specifies a TACACS+ server. Use the **no** form to restore the default.

#### **Syntax**

```
[no] tacacs-server index host [host_ip_address] [port port_number]  
[timeout timeout] [retransmit retransmit] [key key]
```

- *index* - Specifies the index number of the server. (Range: 1)
- *host\_ip\_address* - IP address of the server.
- *port\_number* - The TACACS+ server TCP port used for authentication messages. (Range: 1-65535)
- *timeout* - Number of seconds the switch waits for a reply before resending a request. (Range: 1-540 seconds)
- *retransmit* - Number of times the switch will resend an authentication request to the TACACS+ server. (Range: 1-30)
- *key* - Encryption key used to authenticate logon access for client. Do not use blank spaces in the string. (Maximum length: 26 characters)

#### **Default Setting**

- **port** - 49
- **timeout** - 5 seconds
- **retransmit** - 2

#### **Command Mode**

Global Configuration

#### **Example**

```
Console(config)#tacacs-server host 192.168.1.25  
Console(config)#
```

### **tacacs-server port**

This command specifies the TACACS+ server network port. Use the **no** form to restore the default.

#### **Syntax**

```
tacacs-server port port_number  
no tacacs-server port
```

*port\_number* - TACACS+ server TCP port used for authentication messages. (Range: 1-65535)

#### **Default Setting**

49

#### **Command Mode**

Global Configuration



## Example

```
Console(config)#tacacs-server port 181
Console(config)#
```

## tacacs-server key

This command sets the TACACS+ encryption key. Use the **no** form to restore the default.

### Syntax

**tacacs-server key** *key\_string*  
**no tacacs-server key**

*key\_string* - Encryption key used to authenticate logon access for the client. Do not use blank spaces in the string.  
(Maximum length: 48 characters)

### Default Setting

None

### Command Mode

Global Configuration

## Example

```
Console(config)#tacacs-server key green
Console(config)#
```

## tacacs-server retransmit

This command sets the number of retries. Use the **no** form to restore the default.

### Syntax

**tacacs-server retransmit** *number\_of\_retries*  
**no tacacs-server retransmit**

*number\_of\_retries* - Number of times the switch will try to authenticate logon access via the TACACS+ server. (Range: 1-30)

### Default Setting

2

### Command Mode

Global Configuration

## Example

```
Console(config)#tacacs-server retransmit 5
Console(config)#
```

## 4 Command Line Interface

### **tacacs-server timeout**

This command sets the interval between transmitting authentication requests to the TACACS+ server. Use the **no** form to restore the default.

#### **Syntax**

**tacacs-server timeout** *number\_of\_seconds*

**no tacacs-server timeout**

*number\_of\_seconds* - Number of seconds the switch waits for a reply before resending a request. (Range: 1-540)

#### **Default Setting**

5 seconds

#### **Command Mode**

Global Configuration

#### **Example**

```
Console(config)#tacacs-server timeout 10
Console(config)#
```

**show tacacs-server**

This command displays the current settings for the TACACS+ server.

**Default Setting**

None

**Command Mode**

Privileged Exec

**Example**

```
Console#show tacacs-server

Remote TACACS+ server configuration:

Global Settings:
Communication Key with TACACS+ Server:
Server Port Number:                49
Retransmit Times :                  2
Request Times :                     5

Server 1:
Server IP address:                  192.168.1.25
Communication key with TACACS+ server:
Server port number:                 49
Retransmit Times :                  2
Request Times :                     5

Tacacs server group:
Group Name          Member Index
-----
tacacs+             1

Console#
```

## AAA Commands

The Authentication, authorization, and accounting (AAA) feature provides the main framework for configuring access control on the switch. The AAA functions require the use of configured RADIUS or TACACS+ servers in the network.

Table 4-1 AAA Commands

Command	Function	Mode	Page
aaa group server	Groups security servers in to defined lists	GC	4-114
server	Configures the IP address of a server in a group list	SG	4-115
aaa accounting dot1x	Enables accounting of 802.1X services	GC	4-116
aaa accounting exec	Enables accounting of Exec services	GC	4-117
aaa accounting commands	Enables accounting of Exec mode commands	GC	4-118
aaa accounting update	Enables periodic updates to be sent to the accounting server	GC	4-119
accounting dot1x	Applies an accounting method to an interface for 802.1X service requests	IC	4-119
accounting exec	Applies an accounting method to local console, Telnet or SSH connections	Line	4-120
accounting commands	Applies an accounting method to CLI commands entered by a user	Line	4-120
aaa authorization exec	Enables authorization of Exec sessions	GC	4-121
authorization exec	Applies an authorization method to local console, Telnet or SSH connections	Line	4-122
show accounting	Displays all accounting information	PE	4-122

### aaa group server

Use this command to name a group of security server hosts and enter Server Group Configuration mode for the specified group. To remove a server group from the configuration list, enter the **no** form of this command.

#### Syntax

[no] **aaa group server** {radius | tacacs+} *group-name*

- **radius** - Defines a RADIUS server group.
- **tacacs+** - Defines a TACACS+ server group.
- *group-name* - A text string that names a security server group.  
(Range: 1-7 characters)

#### Default Setting

None

#### Command Mode

Global Configuration

## Example

```
Console(config)#aaa group server radius tps
Console(config-sg-radius)#
```

### server

This command adds a security server to an AAA server group. Use the **no** form to remove the associated server from the group.

### Syntax

**[no] server** {*index* | *ip-address*}

- *index* - Specifies a server index and the sequence to use for the group. (Range: RADIUS 1-5, TACACS+ 1)
- *ip-address* - Specifies the host IP address of a server.

### Default Setting

None

### Command Mode

Server Group Configuration

### Command Usage

- When specifying the index for a RADIUS server, that server index must already be defined by the **radius-server host** command (see page 4-105).
- When specifying the index for a TACACS+ server, that server index must already be defined by the **tacacs-server host** command (see page 4-110).

## Example

```
Console(config)#aaa group server radius tps
Console(config-sg-radius)#server 10.2.68.120
Console(config-sg-radius)#
```

### aaa accounting dot1x

This command enables the accounting of requested 802.1X services for network access. Use the **no** form to disable the accounting service.

#### Syntax

```
aaa accounting dot1x {default | method-name} start-stop group {radius |  
tacacs+ |server-group}  
no aaa accounting dot1x {default | method-name}
```

- **default** - Specifies the default accounting method for service requests.
- *method-name* - Specifies an accounting method for service requests. (Range: 1-255 characters)
- **start-stop** - Records accounting from starting point and stopping point.
- **group** - Specifies the server group to use.
  - **radius** - Specifies all RADIUS hosts configure with the **radius-server host** command described on page 4-105.
  - **tacacs+** - Specifies all TACACS+ hosts configure with the **tacacs-server host** command described on page 4-110.
  - *server-group* - Specifies the name of a server group configured with the **aaa group server** command described on 4-114. (Range: 1-255 characters)

#### Default Setting

Accounting is not enabled  
No servers are specified

#### Command Mode

Global Configuration

#### Command Usage

Note that the **default** and *method-name* fields are only used to describe the accounting method(s) configured on the specified RADIUS or TACACS+ servers, and do not actually send any information to the servers about the methods to use.

#### Example

```
Console(config)#aaa accounting dot1x default start-stop group radius  
Console(config)#
```

### aaa accounting exec

This command enables the accounting of requested Exec services for network access. Use the **no** form to disable the accounting service.

#### Syntax

```
aaa accounting exec {default | method-name} start-stop group {radius |  
tacacs+ | server-group}  
no aaa accounting exec {default | method-name}
```

- **default** - Specifies the default accounting method for service requests.
- *method-name* - Specifies an accounting method for service requests. (Range: 1-255 characters)
- **start-stop** - Records accounting from starting point and stopping point.
- **group** - Specifies the server group to use.
  - **radius** - Specifies all RADIUS hosts configure with the **radius-server host** command described on page 4-105.
  - **tacacs+** - Specifies all TACACS+ hosts configure with the **tacacs-server host** command described on page 4-110.
  - *server-group* - Specifies the name of a server group configured with the **aaa group server** command described on 4-114. (Range: 1-255 characters)

#### Default Setting

Accounting is not enabled  
No servers are specified

#### Command Mode

Global Configuration

#### Command Usage

- This command runs accounting for Exec service requests for the local console and Telnet connections.
- Note that the **default** and *method-name* fields are only used to describe the accounting method(s) configured on the specified RADIUS or TACACS+ servers, and do not actually send any information to the servers about the methods to use.

#### Example

```
Console(config)#aaa accounting exec default start-stop group tacacs+  
Console(config)#
```

## aaa accounting commands

This command enables the accounting of Exec mode commands. Use the **no** form to disable the accounting service.

### Syntax

**aaa accounting commands** *level* {**default** | *method-name*} **start-stop group** {**tacacs+** | *server-group*}

**no aaa accounting commands** *level* {**default** | *method-name*}

- *level* - The privilege level for executing commands. (Range: 0-15)
- **default** - Specifies the default accounting method for service requests.
- *method-name* - Specifies an accounting method for service requests. (Range: 1-255 characters)
- **start-stop** - Records accounting from starting point and stopping point.
- **group** - Specifies the server group to use.
  - **tacacs+** - Specifies all TACACS+ hosts configure with the **tacacs-server host** command described on page 4-110.
  - *server-group* - Specifies the name of a server group configured with the **aaa group server** command described on 4-114. (Range: 1-255 characters)

### Default Setting

Accounting is not enabled  
No servers are specified

### Command Mode

Global Configuration

### Command Usage

- The accounting of Exec mode commands is only supported by TACACS+ servers.
- Note that the **default** and *method-name* fields are only used to describe the accounting method(s) configured on the specified TACACS+ server, and do not actually send any information to the server about the methods to use.

### Example

```
Console(config)#aaa accounting commands 15 default start-stop group
tacacs+
Console(config)#
```



### aaa accounting update

This command enables the sending of periodic updates to the accounting server. Use the **no** form to disable accounting updates.

#### Syntax

**aaa accounting update** [*periodic interval*]

**no aaa accounting update**

*interval* - Sends an interim accounting record to the server at this interval.  
(Range: 1-2147483647 minutes)

#### Default Setting

1 minute

#### Command Mode

Global Configuration

#### Command Usage

- When accounting updates are enabled, the switch issues periodic interim accounting records for all users on the system.
- Using the command without specifying an interim interval enables updates, but does not change the current interval setting.

#### Example

```
Console(config)#aaa accounting update periodic 30
Console(config)#
```

### accounting dot1x

This command applies an accounting method for 802.1X service requests on an interface. Use the **no** form to disable accounting on the interface.

#### Syntax

**accounting dot1x** {**default** | *list-name*}

**no accounting dot1x**

- **default** - Specifies the default method list created with the **aaa accounting dot1x** command (page 4-116).
- *list-name* - Specifies a method list created with the **aaa accounting dot1x** command.

#### Default Setting

None

#### Command Mode

Interface Configuration

### Example

```
Console(config)#interface ethernet 1/2
Console(config-if)#accounting dot1x tps
Console(config-if)#
```

### accounting exec

This command applies an accounting method to local console or Telnet connections. Use the **no** form to disable accounting on the line.

### Syntax

**accounting exec** {**default** | *list-name*}  
**no accounting exec**

- **default** - Specifies the default method list created with the **aaa accounting exec** command (page 4-117).
- *list-name* - Specifies a method list created with the **aaa accounting exec** command.

### Default Setting

None

### Command Mode

Line Configuration

### Example

```
Console(config)#line console
Console(config-line)#accounting exec tps
Console(config-line)#exit
Console(config)#line vty
Console(config-line)#accounting exec default
Console(config-line)#
```

### accounting commands

This command applies an accounting method to entered CLI commands. Use the **no** form to disable accounting for entered commands.

### Syntax

**accounting commands** *level* {**default** | *list-name*}  
**no accounting commands** *level*

- *level* - The privilege level for executing commands. (Range: 0-15)
- **default** - Specifies the default method list created with the **aaa accounting commands** command (page 4-118).
- *list-name* - Specifies a method list created with the **aaa accounting commands** command.

### Default Setting

None

## Command Mode

Line Configuration

### Example

```
Console(config)#line console
Console(config-line)#accounting commands 15 default
Console(config-line)#
```

## aaa authorization exec

This command enables the authorization for Exec access. Use the **no** form to disable the authorization service.

### Syntax

```
aaa authorization exec {default | method-name} group {tacacs+
| server-group}
no aaa authorization exec {default | method-name}
```

- **default** - Specifies the default authorization method for Exec access.
- *method-name* - Specifies an authorization method for Exec access. (Range: 1-255 characters)
- **group** - Specifies the server group to use.
  - **tacacs+** - Specifies all TACACS+ hosts configure with the **tacacs-server host** command described on page 4-110.
  - *server-group* - Specifies the name of a server group configured with the **aaa group server** command described on 4-114. (Range: 1-255 characters)

### Default Setting

Authorization is not enabled  
No servers are specified

## Command Mode

Global Configuration

### Command Usage

- This command performs authorization to determine if a user is allowed to run an Exec shell.
- AAA authentication must be enabled before authorization is enabled.
- If this command is issued without a specified named method, the default method list is applied to all interfaces or lines (where this authorization type applies), except those that have a named method explicitly defined.

### Example

```
Console(config)#aaa authorization exec default group tacacs+
Console(config)#
```

### authorization exec

This command applies an authorization method to local console or Telnet connections. Use the **no** form to disable authorization on the line.

#### Syntax

```
authorization exec {default | list-name}  
no authorization exec
```

- **default** - Specifies the default method list created with the **aaa authorization exec** command (page 4-121).
- *list-name* - Specifies a method list created with the **aaa authorization exec** command.

#### Default Setting

None

#### Command Mode

Line Configuration

#### Example

```
Console(config)#line console  
Console(config-line)#authorization exec tps  
Console(config-line)#exit  
Console(config)#line vty  
Console(config-line)#authorization exec default  
Console(config-line)#
```

### show accounting

This command displays the current accounting settings per function and per port.

#### Syntax

```
show accounting [commands [level]] |  
[[dot1x [statistics [username user-name | interface interface]] |  
exec [statistics] | statistics]
```

- **commands** - Displays accounting information for CLI commands.
- *level* - Displays accounting information for CLI commands entered at the specified privilege level. (Range: 0-15)
- **dot1x** - Displays dot1x accounting information.
- **exec** - Displays Exec accounting records.
- **statistics** - Displays accounting records.
- *user-name* - Displays accounting records for a specified user name.
- *interface*
  - **ethernet *unit/port***
    - *unit* - Stack unit. (Range: 1)
    - *port* - Port number. (Range: 1-28)

#### Default Setting

None

**Command Mode**

Privileged Exec

**Example**

```

Console#show accounting
Accounting type: dot1x
  Method list: default
  Group list: radius
  Interface:

  Method list: tps
  Group list: radius
  Interface: eth 1/2

Accounting type: Exec
  Method list: default
  Group list: radius
  Interface: vty

Console#

```

**Web Server Commands**

This section describes commands used to configure web browser management access to the switch.

**Table 4-34 Web Server Commands**

Command	Function	Mode	Page
ip http port	Specifies the port to be used by the web browser interface	GC	4-123
ip http server	Allows the switch to be monitored or configured from a browser	GC	4-124
ip http secure-server	Enables HTTPS for encrypted communications	GC	4-124
ip http secure-port	Specifies the UDP port number for HTTPS	GC	4-125

**ip http port**

This command specifies the TCP port number used by the web browser interface. Use the **no** form to use the default port.

**Syntax**

```

ip http port port-number
no ip http port

```

*port-number* - The TCP port to be used by the browser interface.  
(Range: 1-65535)

**Default Setting**

80

**Command Mode**

Global Configuration

### Example

```
Console(config)#ip http port 769
Console(config)#
```

### Related Commands

ip http server (4-124)

### ip http server

This command allows this device to be monitored or configured from a browser. Use the **no** form to disable this function.

### Syntax

**[no] ip http server**

### Default Setting

Enabled

### Command Mode

Global Configuration

### Example

```
Console(config)#ip http server
Console(config)#
```

### Related Commands

ip http port (4-123)

### ip http secure-server

This command enables the secure hypertext transfer protocol (HTTPS) over the Secure Socket Layer (SSL), providing secure access (i.e., an encrypted connection) to the switch's web interface. Use the **no** form to disable this function.

### Syntax

**[no] ip http secure-server**

### Default Setting

Enabled

### Command Mode

Global Configuration

### Command Usage

- Both HTTP and HTTPS service can be enabled independently on the switch. However, you cannot configure the HTTP and HTTPS servers to use the same UDP port.
- If you enable HTTPS, you must indicate this in the URL that you specify in your browser: **https://device[:port\_number]**

- When you start HTTPS, the connection is established in this way:
  - The client authenticates the server using the server's digital certificate.
  - The client and server negotiate a set of security protocols to use for the connection.
  - The client and server generate session keys for encrypting and decrypting data.
- The client and server establish a secure encrypted connection.  
A padlock icon should appear in the status bar for Internet Explorer 5.x or above, Netscape 6.2 or above, and Mozilla Firefox 2.0.0.0 or above.
- The following web browsers and operating systems currently support HTTPS:

Table 4-35 HTTPS System Support

Web Browser	Operating System
Internet Explorer 5.0 or later	Windows 98, Windows NT (with service pack 6a), Windows 2000, Windows XP
Netscape 6.2 or later	Windows 98, Windows NT (with service pack 6a), Windows 2000, Windows XP, Solaris 2.6
Mozilla Firefox 2.0.0.0 or later	Windows 2000, Windows XP, Linux

- To specify a secure-site certificate, see “Replacing the Default Secure-site Certificate” on page 3-78. Also refer to the **copy** command on page 4-35.

### Example

```
Console(config)#ip http secure-server
Console(config)#
```

### Related Commands

- `ip http secure-port` (4-125)
- `copy tftp https-certificate` (4-35)

### ip http secure-port

This command specifies the UDP port number used for HTTPS connection to the switch's web interface. Use the **no** form to restore the default port.

#### Syntax

- `ip http secure-port port_number`
- `no ip http secure-port`

*port\_number* – The UDP port used for HTTPS.  
(Range: 1-65535)

#### Default Setting

443

#### Command Mode

Global Configuration

## Command Usage

- You cannot configure the HTTP and HTTPS servers to use the same port.
- If you change the HTTPS port number, clients attempting to connect to the HTTPS server must specify the port number in the URL, in this format:  
`https://device:port_number`

## Example

```
Console(config)#ip http secure-port 1000
Console(config)#
```

## Related Commands

`ip http secure-server (4-124)`

## Telnet Server Commands

Table 4-36 Telnet Server Commands

Command	Function	Mode	Page
<code>ip telnet server</code>	Allows the switch to be monitored or configured from Telnet; also specifies the port to be used by the Telnet interface	GC	4-124

### ip telnet server

This command allows this device to be monitored or configured from Telnet. It also specifies the TCP port number used by the Telnet interface. Use the **no** form without the “port” keyword to disable this function. Use the **no** from with the “port” keyword to use the default port.

### Syntax

```
ip telnet server [port port-number]  
no telnet server [port]
```

- **port** - The TCP port used by the Telnet interface.
- *port-number* - The TCP port number to be used by the browser interface. (Range: 1-65535)

### Default Setting

- Server: Enabled
- Server Port: 23

### Command Mode

Global Configuration

### Example

```
Console(config)#ip telnet server
Console(config)#ip telnet server port 123
Console(config)#
```



## Secure Shell Commands

This section describes the commands used to configure the SSH server. However, note that you also need to install a SSH client on the management station when using this protocol to configure the switch.

**Note:** The switch supports both SSH Version 1.5 and 2.0.

**Table 4-37 SSH Commands**

Command	Function	Mode	Page
ip ssh server	Enables the SSH server on the switch	GC	4-129
ip ssh timeout	Specifies the authentication timeout for the SSH server	GC	4-130
ip ssh authentication-retries	Specifies the number of retries allowed by a client	GC	4-130
ip ssh server-key size	Sets the SSH server key size	GC	4-131
copy tftp public-key	Copies the user's public key from a TFTP server to the switch	PE	4-35
delete public-key	Deletes the public key for the specified user	PE	4-131
ip ssh crypto host-key generate	Generates the host key	PE	4-132
ip ssh crypto zeroize	Clear the host key from RAM	PE	4-132
ip ssh save host-key	Saves the host key from RAM to flash memory	PE	4-133
disconnect	Terminates a line connection	PE	4-48
show ip ssh	Displays the status of the SSH server and the configured values for authentication timeout and retries	PE	4-133
show ssh	Displays the status of current SSH sessions	PE	4-134
show public-key	Shows the public key for the specified user or for the host	PE	4-135
show users	Shows SSH users, including privilege level and public key type	PE	4-31

### Configuration Guidelines

The SSH server on this switch supports both password and public key authentication. If password authentication is specified by the SSH client, then the password can be authenticated either locally or via a RADIUS or TACACS+ remote authentication server, as specified by the **authentication login** command on page 4-103. If public key authentication is specified by the client, then you must configure authentication keys on both the client and the switch as described in the following section. Note that regardless of whether you use public key or password authentication, you still have to generate authentication keys on the switch and enable the SSH server.

To use the SSH server, complete these steps:

1. Generate a Host Key Pair – Use the **ip ssh crypto host-key generate** command to create a host public/private key pair.
2. Provide Host Public Key to Clients – Many SSH client programs automatically import the host public key during the initial connection setup with the switch.

Otherwise, you need to manually create a known hosts file on the management station and place the host public key in it. An entry for a public key in the known hosts file would appear similar to the following example:

```
10.1.0.54 1024 35 15684995401867669259333946775054617325313674890836547254
15020245593199868544358361651999923329781766065830956 10825913212890233
76546801726272571413428762941301196195566782 59566410486957427888146206
51941746772984865468615717739390164779355942303577413098022737087794545
24083971752646358058176716709574804776117
```

3. **Import Client's Public Key to the Switch – Use the `copy ftp public-key` command to copy a file containing the public key for all the SSH client's granted management access to the switch. (Note that these clients must be configured locally on the switch via the User Accounts page as described on page 3-58.) The clients are subsequently authenticated using these keys. The current firmware only accepts public key files based on standard UNIX format as shown in the following example for an RSA Version 1 key:**

```
1024 35 1341081685609893921040944920155425347631641921872958921143173880
05553616163105177594083868631109291232226828519254374603100937187721199
69631781366277414168985132049117204830339254324101637997592371449011938
00609025394840848271781943722884025331159521348610229029789827213532671
31629432532818915045306393916643 steve@192.168.1.19
```

4. **Set the Optional Parameters – Set other optional parameters, including the authentication timeout, the number of retries, and the server key size.**
5. **Enable SSH Service – Use the `ip ssh server` command to enable the SSH server on the switch.**
6. **Authentication – One of the following authentication methods is employed:**
  - Password Authentication (for SSH v1.5 or V2 Clients)*
    - a. The client sends its password to the server.
    - b. The switch compares the client's password to those stored in memory.
    - c. If a match is found, the connection is allowed.

**Note:** To use SSH with only password authentication, the host public key must still be given to the client, either during initial connection or manually entered into the known host file. However, you do not need to configure the client's keys.

**Public Key Authentication –** When an SSH client attempts to contact the switch, the SSH server uses the host key pair to negotiate a session key and encryption method. Only clients that have a private key corresponding to the public keys stored on the switch can access it. The following exchanges take place during this process:

### *Authenticating SSH v1.5 Clients*

- a. The client sends its RSA public key to the switch.
- b. The switch compares the client's public key to those stored in memory.
- c. If a match is found, the switch uses its secret key to generate a random 256-bit string as a challenge, encrypts this string with the user's public key, and sends it to the client.

- d. The client uses its private key to decrypt the challenge string, computes the MD5 checksum, and sends the checksum back to the switch.
- e. The switch compares the checksum sent from the client against that computed for the original string it sent. If the two checksums match, this means that the client's private key corresponds to an authorized public key, and the client is authenticated.

#### *Authenticating SSH v2 Clients*

- a. The client first queries the switch to determine if DSA public key authentication using a preferred algorithm is acceptable.
- b. If the specified algorithm is supported by the switch, it notifies the client to proceed with the authentication process. Otherwise, it rejects the request.
- c. The client sends a signature generated using the private key to the switch.
- d. When the server receives this message, it checks whether the supplied key is acceptable for authentication, and if so, it then checks whether the signature is correct. If both checks succeed, the client is authenticated.

**Note:** The SSH server supports up to four client sessions. The maximum number of client sessions includes both current Telnet sessions and SSH sessions.

### **ip ssh server**

This command enables the Secure Shell (SSH) server on this switch. Use the **no** form to disable this service.

#### **Syntax**

[no] ip ssh server

#### **Default Setting**

Disabled

#### **Command Mode**

Global Configuration

#### **Command Usage**

- The SSH server supports up to four client sessions. The maximum number of client sessions includes both current Telnet sessions and SSH sessions.
- The SSH server uses DSA or RSA for key exchange when the client first establishes a connection with the switch, and then negotiates with the client to select either DES (56-bit) or 3DES (168-bit) for data encryption.
- You must generate the host key before enabling the SSH server.

#### **Example**

```
Console#ip ssh crypto host-key generate dsa
Console#configure
Console(config)#ip ssh server
Console(config)#
```

## 4 Command Line Interface

### Related Commands

ip ssh crypto host-key generate (4-132)  
show ssh (4-134)

### ip ssh timeout

This command configures the timeout for the SSH server. Use the **no** form to restore the default setting.

### Syntax

**ip ssh timeout** *seconds*  
**no ip ssh timeout**

*seconds* – The timeout for client response during SSH negotiation.  
(Range: 1-120)

### Default Setting

10 seconds

### Command Mode

Global Configuration

### Command Usage

The **timeout** specifies the interval the switch will wait for a response from the client during the SSH negotiation phase. Once an SSH session has been established, the timeout for user input is controlled by the **exec-timeout** command for vty sessions.

### Example

```
Console(config)#ip ssh timeout 60
Console(config)#
```

### Related Commands

exec-timeout (4-44)  
show ip ssh (4-133)

### ip ssh authentication-retries

This command configures the number of times the SSH server attempts to reauthenticate a user. Use the **no** form to restore the default setting.

### Syntax

**ip ssh authentication-retries** *count*  
**no ip ssh authentication-retries**

*count* – The number of authentication attempts permitted after which the interface is reset. (Range: 1-5)

### Default Setting

3

## Command Mode

Global Configuration

## Example

```
Console(config)#ip ssh authentication-retires 2
Console(config)#
```

## Related Commands

show ip ssh (4-133)

## ip ssh server-key size

This command sets the SSH server key size. Use the **no** form to restore the default setting.

## Syntax

**ip ssh server-key size** *key-size*

**no ip ssh server-key size**

*key-size* – The size of server key. (Range: 512-896 bits)

## Default Setting

768 bits

## Command Mode

Global Configuration

## Command Usage

- The server key is a private key that is never shared outside the switch.
- The host key is shared with the SSH client, and is fixed at 1024 bits.

## Example

```
Console(config)#ip ssh server-key size 512
Console(config)#
```

## delete public-key

This command deletes the specified user's public key.

## Syntax

**delete public-key** *username* [**dsa** | **rsa**]

- *username* – Name of an SSH user. (Range: 1-8 characters)
- **dsa** – DSA public key type.
- **rsa** – RSA public key type.

## Default Setting

Deletes both the DSA and RSA key.

## Command Mode

Privileged Exec

### Example

```
Console#delete public-key admin dsa
Console#
```

### ip ssh crypto host-key generate

This command generates the host key pair (i.e., public and private).

#### Syntax

```
ip ssh crypto host-key generate [dsa | rsa]
```

- **dsa** – DSA (Version 2) key type.
- **rsa** – RSA (Version 1) key type.

#### Default Setting

Generates both the DSA and RSA key pairs.

#### Command Mode

Privileged Exec

#### Command Usage

- This command stores the host key pair in memory (i.e., RAM). Use the **ip ssh save host-key** command to save the host key pair to flash memory.
- Some SSH client programs automatically add the public key to the known hosts file as part of the configuration process. Otherwise, you must manually create a known hosts file and place the host public key in it.
- The SSH server uses this host key to negotiate a session key and encryption method with the client trying to connect to it.

### Example

```
Console#ip ssh crypto host-key generate dsa
Console#
```

#### Related Commands

```
ip ssh crypto zeroize (4-132)
ip ssh save host-key (4-133)
```

### ip ssh crypto zeroize

This command clears the host key from memory (i.e. RAM).

#### Syntax

```
ip ssh crypto zeroize [dsa | rsa]
```

- **dsa** – DSA key type.
- **rsa** – RSA key type.

#### Default Setting

Clears both the DSA and RSA key.

**Command Mode**

Privileged Exec

**Command Usage**

- This command clears the host key from volatile memory (RAM). Use the **no ip ssh save host-key** command to clear the host key from flash memory.
- The SSH server must be disabled before you can execute this command.

**Example**

```
Console#ip ssh crypto zeroize dsa
Console#
```

**Related Commands**

- ip ssh crypto host-key generate (4-132)
- ip ssh save host-key (4-133)
- no ip ssh server (4-129)

**ip ssh save host-key**

This command saves host key from RAM to flash memory.

**Syntax**

**ip ssh save host-key [dsa | rsa]**

- **dsa** – DSA key type.
- **rsa** – RSA key type.

**Default Setting**

Saves both the DSA and RSA key.

**Command Mode**

Privileged Exec

**Example**

```
Console#ip ssh save host-key dsa
Console#
```

**Related Commands**

- ip ssh crypto host-key generate (4-132)

**show ip ssh**

This command displays the connection settings used when authenticating client access to the SSH server.

**Command Mode**

Privileged Exec

## Example

```

Console#show ip ssh
SSH Enabled - version 1.99
Negotiation timeout: 120 secs; Authentication retries: 3
Server key size: 768 bits
Console#
    
```

## show ssh

This command displays the current SSH server connections.

## Command Mode

Privileged Exec

## Example

```

Console#show ssh
Connection Version State Username Encryption
0 2.0 Session-Started admin ctos aes128-cbc-hmac-md5
stoc aes128-cbc-hmac-md5
Console#
    
```

**Table 4-38 show ssh - display description**

Field	Description
Session	The session number. (Range: 0-3)
Version	The Secure Shell version number.
State	The authentication negotiation state. (Values: Negotiation-Started, Authentication-Started, Session-Started)
Username	The user name of the client.
Encryption	<p>The encryption method is automatically negotiated between the client and server. Options for SSHv1.5 include: DES, 3DES Options for SSHv2.0 can include different algorithms for the client-to-server (ctos) and server-to-client (stoc):</p> <pre> aes128-cbc-hmac-sha1 aes192-cbc-hmac-sha1 aes256-cbc-hmac-sha1 3des-cbc-hmac-sha1 blowfish-cbc-hmac-sha1 aes128-cbc-hmac-md5 aes192-cbc-hmac-md5 aes256-cbc-hmac-md5 3des-cbc-hmac-md5 blowfish-cbc-hmac-md5                     </pre> <p><i>Terminology:</i>  DES – Data Encryption Standard (56-bit key)  3DES – Triple-DES (Uses three iterations of DES, 112-bit key)  aes – Advanced Encryption Standard (160 or 224-bit key)  blowfish – Blowfish (32-448 bit key)  cbc – cypher-block chaining  sha1 – Secure Hash Algorithm 1 (160-bit hashes)  md5 – Message Digest algorithm number 5 (128-bit hashes)</p>



## show public-key

This command shows the public key for the specified user or for the host.

### Syntax

```
show public-key [user [username]] host]
```

*username* – Name of an SSH user. (Range: 1-8 characters)

### Default Setting

Shows all public keys.

### Command Mode

Privileged Exec

### Command Usage

- If no parameters are entered, all keys are displayed. If the user keyword is entered, but no user name is specified, then the public keys for all users are displayed.
- When an RSA key is displayed, the first field indicates the size of the host key (e.g., 1024), the second field is the encoded public exponent (e.g., 35), and the last string is the encoded modulus. When a DSA key is displayed, the first field indicates that the encryption method used by SSH is based on the Digital Signature Standard (DSS), and the last string is the encoded modulus.

### Example

```

Console#show public-key host
Host:
RSA:
1024 35
1568499540186766925933394677505461732531367489083654725415020245593199868
5443583616519999233297817660658309586108259132128902337654680172627257141
3428762941301196195566782595664104869574278881462065194174677298486546861
5717739390164779355942303577413098022737087794545240839717526463580581767
16709574804776117
DSA:
ssh-dss AAAB3NzaC1kc3MAAACBAPWKZTPbsRIB8ydEXcxM3dyV/yrDbKStIlnzD/Dg0h2Hxc
YV44sXZ2JXhamLK6P8bvuiyacWbUW/a4PAtp1KMSdqgKeh3hKoA3vRRSy1N2XFfAKx15fwFfv
J1PdOkFgzLGMinvSNYQwiQXbktBH0Z4mUZpE85PwxDZMaCNBPjBrAAAAFQChb4vsdfQGNiJw
bvwrNLaQ77isiwAAAIeAsy5YWDc99ebYHNRj5kh47wY4i8czvH+/p9cnrfwFTMU01VFDly3IR
2G395Nly5Qd7ZDxfA9mCOFT/yyEfbbobMJZi8oGCst.SNOxrZZVnMgWrTYfdRkX7YKBw/Kjw6Bm
iFq70+jAhf1Dg45loAc27s6TLdtny1wRq/ow2eTCD5nekAAACBAJ8rMccXTxHLFaczWS7EjOy
Dbs1oBfPuSAb4oAsyjKXKVYNLQkTLZfcFRu41bS2KV5LAWecsigF/+DjKGWtPNIQqabKgYCw2
o/dVzX4Gg+yqdTlYmGA7fHGm8ARGeiG4ssFKy4Z6DmYPXFum1Yg0fhLwuHpOSKdxT3kk475S7
w0W
Console#

```

## 802.1X Port Authentication

The switch supports IEEE 802.1X (dot1x) port-based access control that prevents unauthorized access to the network by requiring users to first submit credentials for authentication. Client authentication is controlled centrally by a RADIUS server using EAP (Extensible Authentication Protocol).

**Table 4-39 802.1X Port Authentication**

Command	Function	Mode	Page
dot1x system-auth-control	Enables dot1x globally on the switch.	GC	4-136
dot1x default	Resets all dot1x parameters to their default values	GC	4-137
dot1x max-req	Sets the maximum number of times that the switch retransmits an EAP request/identity packet to the client before it times out the authentication session	IC	4-137
dot1x port-control	Sets dot1x mode for a port interface	IC	4-137
dot1x operation-mode	Allows single or multiple hosts on an dot1x port	IC	4-138
dot1x re-authenticate	Forces re-authentication on specific ports	PE	4-139
dot1x re-authentication	Enables re-authentication for all ports	IC	4-139
dot1x timeout quiet-period	Sets the time that a switch port waits after the Max Request Count has been exceeded before attempting to acquire a new client	IC	4-140
dot1x timeout re-authperiod	Sets the time period after which a connected client must be re-authenticated	IC	4-140
dot1x timeout tx-period	Sets the time period during an authentication session that the switch waits before re-transmitting an EAP packet	IC	4-141
dot1x intrusion-action	Sets the port response to intrusion when authentication fails	IC	4-141
show dot1x	Shows all dot1x related information	PE	4-142

### dot1x system-auth-control

This command enables 802.1X port authentication globally on the switch. Use the **no** form to restore the default.

#### Syntax

**[no] dotx system-auth-control**

#### Default Setting

Disabled

#### Command Mode

Global Configuration

#### Example

```
Console(config)#dot1x system-auth-control
Console(config)#
```

### dot1x default

This command sets all configurable dot1x global and port settings to their default values.

#### Command Mode

Global Configuration

#### Example

```
Console(config)#dot1x default
Console(config)#
```

### dot1x max-req

This command sets the maximum number of times the switch port will retransmit an EAP request/identity packet to the client before it times out the authentication session. Use the **no** form to restore the default.

#### Syntax

```
dot1x max-req count
no dot1x max-req
```

*count* – The maximum number of requests (Range: 1-10)

#### Default

2

#### Command Mode

Interface Configuration

#### Example

```
Console(config)#interface eth 1/2
Console(config-if)#dot1x max-req 2
Console(config-if)#
```

### dot1x port-control

This command sets the dot1x mode on a port interface. Use the **no** form to restore the default.

#### Syntax

```
dot1x port-control {auto | force-authorized | force-unauthorized}
no dot1x port-control
```

- **auto** – Requires a dot1x-aware connected client to be authorized by the RADIUS server. Clients that are not dot1x-aware will be denied access.
- **force-authorized** – Configures the port to grant access to all clients, either dot1x-aware or otherwise.
- **force-unauthorized** – Configures the port to deny access to all clients, either dot1x-aware or otherwise.

## 4 Command Line Interface

### Default

force-authorized

### Command Mode

Interface Configuration

### Example

```
Console(config)#interface eth 1/2
Console(config-if)#dot1x port-control auto
Console(config-if)#
```

### dot1x operation-mode

This command allows single or multiple hosts (clients) to connect to an 802.1X-authorized port. Use the **no** form with no keywords to restore the default to single host. Use the **no** form with the **multi-host max-count** keywords to restore the default maximum count.

### Syntax

**dot1x operation-mode {single-host | multi-host [max-count count]}**  
**no dot1x operation-mode [multi-host max-count]**

- **single-host** – Allows only a single host to connect to this port.
- **multi-host** – Allows multiple host to connect to this port.
- **max-count** – Keyword for the maximum number of hosts.  
*count* – The maximum number of hosts that can connect to a port.  
(Range: 1-1024; Default: 5)

### Default

Single-host

### Command Mode

Interface Configuration

### Command Usage

- The “max-count” parameter specified by this command is only effective if the dot1x mode is set to “auto” by the **dot1x port-control** command (page 4-137).
- In “multi-host” mode, only one host connected to a port needs to pass authentication for all other hosts to be granted network access. Similarly, a port can become unauthorized for all hosts if one attached host fails re-authentication or sends an EAPOL logoff message.

### Example

```
Console(config)#interface eth 1/2
Console(config-if)#dot1x operation-mode multi-host max-count 10
Console(config-if)#
```

## dot1x re-authenticate

This command forces re-authentication on all ports or a specific interface.

### Syntax

**dot1x re-authenticate** [*interface*]

*interface*

- **ethernet** *unit/port*
  - *unit* - Stack unit. (Range: 1)
  - *port* - Port number. (Range: 1-28)

### Command Mode

Privileged Exec

### Command Usage

The re-authentication process verifies the connected client's user ID and password on the RADIUS server. During re-authentication, the client remains connected the network and the process is handled transparently by the dot1x client software. Only if re-authentication fails is the port blocked or the user assigned to the Guest VLAN (see **dot1x intrusion-action** on page 4-141).

### Example

```
Console#dot1x re-authenticate
Console#
```

## dot1x re-authentication

This command enables periodic re-authentication globally for all ports. Use the **no** form to disable re-authentication.

### Syntax

**[no] dot1x re-authentication**

### Command Mode

Interface Configuration

### Command Usage

- The re-authentication process verifies the connected client's user ID and password on the RADIUS server. During re-authentication, the client remains connected the network and the process is handled transparently by the dot1x client software. Only if re-authentication fails is the port blocked or the user assigned to the Guest VLAN (see **dot1x intrusion-action** on page 4-141).
- The connected client is re-authenticated after the interval specified by the **dot1x timeout re-authperiod** command. The default is 3600 seconds.

### Example

```
Console(config)#interface eth 1/2
Console(config-if)#dot1x re-authentication
Console(config-if)#
```

### Related Commands

dot1x timeout re-authperiod (4-140)

### dot1x timeout quiet-period

This command sets the time that a switch port waits after the Max Request Count has been exceeded before attempting to acquire a new client. Use the **no** form to reset the default.

### Syntax

```
dot1x timeout quiet-period seconds
no dot1x timeout quiet-period
```

*seconds* - The number of seconds. (Range: 1-65535)

### Default

60 seconds

### Command Mode

Interface Configuration

### Example

```
Console(config)#interface eth 1/2
Console(config-if)#dot1x timeout quiet-period 350
Console(config-if)#
```

### dot1x timeout re-authperiod

This command sets the time period after which a connected client must be re-authenticated.

### Syntax

```
dot1x timeout re-authperiod seconds
no dot1x timeout re-authperiod
```

*seconds* - The number of seconds. (Range: 1-65535)

### Default

3600 seconds

### Command Mode

Interface Configuration

## Example

```
Console(config)#interface eth 1/2
Console(config-if)#dot1x timeout re-authperiod 300
Console(config-if)#
```

### dot1x timeout tx-period

This command sets the time that an interface on the switch waits during an authentication session before re-transmitting an EAP packet. Use the **no** form to reset to the default value.

#### Syntax

```
dot1x timeout tx-period seconds
no dot1x timeout tx-period
```

*seconds* - The number of seconds. (Range: 1-65535)

#### Default

30 seconds

#### Command Mode

Interface Configuration

## Example

```
Console(config)#interface eth 1/2
Console(config-if)#dot1x timeout tx-period 300
Console(config-if)#
```

### dot1x intrusion-action

This command sets the port's response to a failed authentication, either to block all traffic, or to assign all traffic for the port to a guest VLAN. Use the **no** form to reset the default.

#### Syntax

```
dot1x intrusion-action {block-traffic | guest-vlan}
no dot1x intrusion-action
```

#### Default

block-traffic

#### Command Mode

Interface Configuration

#### Command Usage

For guest VLAN assignment to be successful, the VLAN must be configured and set as active ("vlan database" on page 4-252) and assigned as the guest VLAN for the port ("network-access guest-vlan" on page 4-153).

### Example

```
Console(config)#interface eth 1/2
Console(config-if)#dot1x intrusion-action guest-vlan
Console(config-if)#
```

### show dot1x

This command shows general port authentication related settings on the switch or a specific interface.

### Syntax

**show dot1x** [**statistics**] [**interface** *interface*]

- **statistics** - Displays dot1x status for each port.
- *interface*
  - **ethernet** *unit/port*
    - *unit* - Stack unit. (Range: 1)
    - *port* - Port number. (Range: 1-28)

### Command Mode

Privileged Exec

### Command Usage

This command displays the following information:

- *Global 802.1X Parameters* – Shows whether or not 802.1X port authentication is globally enabled on the switch.
- *802.1X Port Summary* – Displays the port access control parameters for each interface, including the following items:
  - Status – Administrative state for port access control.
  - Operation Mode – Dot1x port control operation mode (page 4-138).
  - Mode – Dot1x port control mode (page 4-137).
  - Authorized – Authorization status (yes or n/a - not authorized).
- *802.1X Port Details* – Displays the port access control parameters for each interface, including the following items:
  - reauth-enabled – Periodic re-authentication (page 4-139).
  - reauth-period – Time after which a connected client must be re-authenticated (page 4-140).
  - quiet-period – Time a port waits after Max Request Count is exceeded before attempting to acquire a new client (page 4-140).
  - tx-period – Time a port waits during authentication session before re-transmitting EAP packet (page 4-141).
  - supplicant-timeout – Supplicant timeout.
  - server-timeout – Server timeout.
  - reauth-max – Maximum number of reauthentication attempts.



- max-req – Maximum number of times a port will retransmit an EAP request/identity packet to the client before it times out the authentication session (page 4-137).
- Status – Authorization status (authorized or not).
- Operation Mode – Shows if single or multiple hosts (clients) can connect to an 802.1X-authorized port.
- Max Count – The maximum number of hosts allowed to access this port (page 4-138).
- Port-control – Shows the dot1x mode on a port as auto, force-authorized, or force-unauthorized (page 4-137).
- Supplicant – MAC address of authorized client.
- Current Identifier – The integer (0-255) used by the Authenticator to identify the current authentication session.
- Intrusion action – Shows whether the switch will block all non-EAP traffic or assign traffic on the port to a guest VLAN if authentication fails.
- *Authenticator State Machine*
  - State – Current state (including initialize, disconnected, connecting, authenticating, authenticated, aborting, held, force\_authorized, force\_unauthorized).
  - Reauth Count – Number of times connecting state is re-entered.
- *Backend State Machine*
  - State – Current state (including request, response, success, fail, timeout, idle, initialize).
  - Request Count – Number of EAP Request packets sent to the Supplicant without receiving a response.
  - Identifier (Server) – Identifier carried in the most recent EAP Success, Failure or Request packet received from the Authentication Server.
- *Reauthentication State Machine*
  - State – Current state (including initialize, reauthenticate).

## Example

```
Console#show dot1x
Global 802.1X Parameters
  system-auth-control: enable

802.1X Port Summary

Port Name   Status           Operation Mode   Mode              Authorized
1/1         disabled        Single-Host     ForceAuthorized   n/a
1/2         enabled         Single-Host     auto              yes
:
1/28        disabled        Single-Host     ForceAuthorized   n/a

802.1X Port Details

802.1X is disabled on port 1/1

802.1X is enabled on port 1/2
reauth-enabled: Enable
reauth-period: 1800
quiet-period: 30
tx-period: 40
supplicant-timeout: 30
server-timeout: 10
reauth-max: 2
max-req: 5
Status           Authorized
Operation mode   Single-Host
Max count        5
Port-control     Auto
Supplicant       00-12-cf-49-5e-dc
Current Identifier 3
Intrusion action Guest VLAN

Authenticator State Machine
State            Authenticated
Reauth Count     0

Backend State Machine
State            Idle
Request Count    0
Identifier(Server) 2

Reauthentication State Machine
State            Initialize
:
```

## Management IP Filter Commands

This section describes commands used to configure IP management access to the switch.

Table 4-40 IP Filter Commands

Command	Function	Mode	Page
management	Configures IP addresses that are allowed management access	GC	4-145
show management	Displays the switch to be monitored or configured from a browser	PE	4-146

### management

This command specifies the client IP addresses that are allowed management access to the switch through various protocols. Use the **no** form to restore the default setting.

### Syntax

```
[no] management {all-client | http-client | snmp-client | telnet-client}
      start-address [end-address]
```

- **all-client** - Adds IP address(es) to the SNMP, web and Telnet groups.
- **http-client** - Adds IP address(es) to the web group.
- **snmp-client** - Adds IP address(es) to the SNMP group.
- **telnet-client** - Adds IP address(es) to the Telnet group.
- *start-address* - A single IP address, or the starting address of a range.
- *end-address* - The end address of a range.

### Default Setting

All addresses

### Command Mode

Global Configuration

### Command Usage

- If anyone tries to access a management interface on the switch from an invalid address, the switch will reject the connection, enter an event message in the system log, and send a trap message to the trap manager.
- IP address can be configured for SNMP, web and Telnet access respectively. Each of these groups can include up to five different sets of addresses, either individual addresses or address ranges.
- When entering addresses for the same group (i.e., SNMP, web or Telnet), the switch will not accept overlapping address ranges. When entering addresses for different groups, the switch will accept overlapping address ranges.
- You cannot delete an individual address from a specified range. You must delete the entire range, and reenter the addresses.
- You can delete an address range just by specifying the start address, or by specifying both the start address and end address.

## Example

This example restricts management access to the indicated addresses.

```
Console(config)#management all-client 192.168.1.19
Console(config)#management all-client 192.168.1.25 192.168.1.30
Console(config)#
```

## show management

This command displays the client IP addresses that are allowed management access to the switch through various protocols.

## Syntax

**show management {all-client | http-client | snmp-client | telnet-client}**

- **all-client** - Adds IP address(es) to the SNMP, web and Telnet groups.
- **http-client** - Adds IP address(es) to the web group.
- **snmp-client** - Adds IP address(es) to the SNMP group.
- **telnet-client** - Adds IP address(es) to the Telnet group.

## Command Mode

Privileged Exec

## Example

```
Console#show management all-client
Management IP Filter
HTTP-Client:
  Start IP address      End IP address
-----
1. 192.168.1.19         192.168.1.19
2. 192.168.1.25         192.168.1.30

SNMP-Client:
  Start IP address      End IP address
-----
1. 192.168.1.19         192.168.1.19
2. 192.168.1.25         192.168.1.30

TELNET-Client:
  Start IP address      End IP address
-----
1. 192.168.1.19         192.168.1.19
2. 192.168.1.25         192.168.1.30
Console#
```

## General Security Measures

This switch supports many methods of segregating traffic for clients attached to each of the data ports, and for ensuring that only authorized clients gain access to the network. Private VLANs and port-based authentication using IEEE 802.1X are commonly used for these purposes. In addition to these methods, several other options of providing client security are described in this section. These include port-based authentication, which can be configured to allow network client access by specifying a fixed set of MAC addresses. The addresses assigned to DHCP clients can also be carefully controlled using static or dynamic bindings with the IP Source Guard and DHCP Snooping commands.

**Table 4-41 Client Security Commands**

Command Group	Function	Page
Private VLANs	Configures private VLANs, including uplink and downlink ports	4-269
Port Security*	Configures secure addresses for a port	4-148
Port Authentication*	Configures host authentication on specific ports using 802.1X	4-136
Network Access*	Configures MAC authentication and dynamic VLAN assignment	4-149
Web Authentication*	Configures Web authentication	4-157
Access Control Lists*	Provides filtering for IP frames (based on address, protocol, TCP/UDP port number or TCP control code) or non-IP frames (based on MAC address or Ethernet type)	4-175
DHCP Snooping*	Filters untrusted DHCP messages on unsecure ports by building and maintaining a DHCP snooping binding table	4-163
IP Source Guard*	Filters IP traffic on unsecure ports for which the source address cannot be identified via DHCP snooping nor static source bindings	4-171

\* The priority of execution for these filtering commands is Port Security, Port Authentication, Network Access, Web Authentication, Access Control Lists, DHCP Snooping, and then IP Source Guard.

## Port Security Commands

These commands can be used to enable port security on a port. When using port security, the switch stops learning new MAC addresses on the specified port when it has reached a configured maximum number. Only incoming traffic with source addresses already stored in the dynamic or static address table for this port will be authorized to access the network. The port will drop any incoming frames with a source MAC address that is unknown or has been previously learned from another port. If a device with an unauthorized MAC address attempts to use the switch port, the intrusion will be detected and the switch can automatically take action by disabling the port and sending a trap message.

**Table 4-42 Port Security Commands**

Command	Function	Mode	Page
port security	Configures a secure port	IC	4-148
mac-address-table static	Maps a static address to a port in a VLAN	GC	4-221
show mac-address-table	Displays entries in the bridge-forwarding database	PE	4-223

### port security

This command enables or configures port security. Use the **no** form without any keywords to disable port security. Use the **no** form with the appropriate keyword to restore the default settings for a response to security violation or for the maximum number of allowed addresses.

### Syntax

```
port security [action {shutdown | trap | trap-and-shutdown}
| max-mac-count address-count]
no port security [action | max-mac-count]
```

- **action** - Response to take when port security is violated.
  - **shutdown** - Disable port only.
  - **trap** - Issue SNMP trap message only.
  - **trap-and-shutdown** - Issue SNMP trap message and disable port.
- **max-mac-count**
  - *address-count* - The maximum number of MAC addresses that can be learned on a port. (Range: 0-1024)

### Default Setting

- Status: Disabled
- Action: None
- Maximum Addresses: 0

### Command Mode

Interface Configuration (Ethernet)

## Command Usage

- If you enable port security, the switch stops learning new MAC addresses on the specified port when it has reached a configured maximum number. Only incoming traffic with source addresses already stored in the dynamic or static address table will be accepted.
- Use the **port security** command to enable security on a port. Then use the **port security action** command to set the response to a port security violation, and the **port security max-mac-count** command to set the maximum number of addresses allowed on a port.
- You can also manually add secure addresses with the **mac-address-table static** command.
- A secure port has the following restrictions:
  - Cannot be connected to a network interconnection device.
  - Cannot be a trunk port.
- If a port is disabled due to a security violation, it must be manually re-enabled using the **no shutdown** command.

## Example

The following example enables port security for port 5, and sets the response to a security violation to issue a trap message:

```
Console(config)#interface ethernet 1/5
Console(config-if)#port security
Console(config-if)#port security action trap
Console(config-if)#
```

## Related Commands

- shutdown (4-194)
- mac-address-table static (4-221)
- show mac-address-table (4-223)

## Network Access (MAC Address Authentication)

Network Access authentication controls access to the network by authenticating the MAC address of each host that attempts to connect to a switch port. Traffic received from a specific MAC address is forwarded by the switch only if the source MAC address is successfully authenticated by a central RADIUS server. While authentication for a MAC address is in progress, all traffic is blocked until authentication is completed. Once successfully authenticated, the RADIUS server may optionally assign VLAN settings for the switch port.

Table 4-43 Network Access

Command	Function	Mode	Page
network-access aging	Enables MAC address aging	GC	4-150
network-access mode	Enables MAC authentication on an interface	IC	4-151
network-access max-mac-count	Sets a maximum for authenticated MAC addresses on an interface	IC	4-152

**Table 4-43 Network Access (Continued)**

Command	Function	Mode	Page
network-access dynamic-vlan	Enables dynamic VLAN assignment from a RADIUS server	IC	4-152
network-access guest-vlan	Specifies the guest VLAN	IC	4-153
mac-authentication reauth-time	Sets the time period after which a connected MAC address must be re-authenticated	GC	4-154
mac-authentication intrusion-action	Determines the port response when a connected host fails MAC authentication.	IC	4-154
mac-authentication max-mac-count	Sets a maximum for mac-authentication authenticated MAC addresses on an interface	IC	4-155
clear network-access	Clears authenticated MAC addresses from the address table	PE	4-155
show network-access	Displays the MAC authentication settings for port interfaces	PE	4-156
show network-access mac-address-table	Displays information for entries in the secure MAC address table	PE	4-156

## network-access aging

Use this command to enable MAC address aging for the secure MAC address table. Use the **no** form of this command to disable address aging.

### Syntax

**[no] network-access aging**

### Default Setting

Disabled

### Command Mode

Global Configuration

### Command Usage

Authenticated MAC addresses are stored as dynamic entries in the switch secure MAC address table and are removed when the aging time expires. The maximum number of secure MAC addresses supported for the switch system is 1024.

### Example

```
Console(config-if)#network-access mode mac-authentication
Console(config-if)#
```



## network-access mode

Use this command to enable network access authentication on a port. Use the **no** form of this command to disable network access authentication.

### Syntax

**[no] network-access mode mac-authentication**

### Default Setting

Disabled

### Command Mode

Interface Configuration

### Command Usage

- When enabled on a port, the authentication process sends a Password Authentication Protocol (PAP) request to a configured RADIUS server. The username and password are both equal to the MAC address being authenticated.
- On the RADIUS server, PAP username and passwords must be configured in the MAC address format XX-XX-XX-XX-XX-XX (all in upper case).
- Authenticated MAC addresses are stored as dynamic entries in the switch secure MAC address table and are removed when the aging time expires. The maximum number of secure MAC addresses supported for the switch system is 1024.
- Configured static MAC addresses are added to the secure address table when seen on a switch port. Static addresses are treated as authenticated without sending a request to a RADIUS server.
- MAC authentication, 802.1X, and port security cannot be configured together on the same port. Only one security mechanism can be applied.
- MAC authentication cannot be configured on trunk ports.
- When port status changes to down, all MAC addresses are cleared from the secure MAC address table. Static VLAN assignments are not restored.
- The RADIUS server may optionally return a VLAN identifier list. VLAN identifier list is carried in the "Tunnel-Private-Group-ID" attribute. The VLAN list can contain multiple VLAN identifiers in the format "1u,2t," where "u" indicates untagged VLAN and "t" tagged VLAN. The "Tunnel-Type" attribute should be set to "VLAN," and the "Tunnel-Medium-Type" attribute set to "802."

### Example

```
Console(config-if)#network-access mode mac-authentication
Console(config-if)#
```

### network-access max-mac-count

Use this command to set the maximum number of MAC addresses that can be authenticated on a port interface via all forms of authentication. Use the **no** form of this command to restore the default.

#### Syntax

```
network-access max-mac-count count  
no network-access max-mac-count
```

*count* - The maximum number of authenticated MAC addresses allowed.  
(Range: 1 to 2048; 0 for unlimited)

#### Default Setting

2048

#### Command Mode

Interface Configuration

#### Command Usage

The maximum number of MAC addresses per port is 2048, and the maximum number of secure MAC addresses supported for the switch system is 1024. When the limit is reached, all new MAC addresses are treated as authentication failed.

#### Example

```
Console(config-if)#network-access max-mac-count 5  
Console(config-if)#
```

### network-access dynamic-vlan

Use this command to enable dynamic VLAN assignment for an authenticated port. Use the **no** form to disable dynamic VLAN assignment.

#### Syntax

```
[no] network-access dynamic-vlan
```

#### Default Setting

Enabled

#### Command Mode

Interface Configuration

#### Command Usage

- When enabled, the VLAN identifiers returned by the RADIUS server will be applied to the port, providing the VLANs have already been created on the switch. GVRP is not used to create the VLANs.
- The VLAN settings specified by the first authenticated MAC address are implemented for a port. Other authenticated MAC addresses on the port must

have same VLAN configuration, or they are treated as an authentication failure.

- If dynamic VLAN assignment is enabled on a port and the RADIUS server returns no VLAN configuration, the authentication is still treated as a success, and the host assigned to the default untagged VLAN.
- When the dynamic VLAN assignment status is changed on a port, all authenticated addresses are cleared from the secure MAC address table.

### Example

The following example enables dynamic VLAN assignment on port 1.

```
Console(config)#interface ethernet 1/1
Console(config-if)#network-access dynamic-vlan
Console(config-if)#
```

### network-access guest-vlan

Use this command to assign all traffic on a port to a guest VLAN when network access (MAC authentication) or 802.1x authentication is rejected. Use the **no** form of this command to disable guest VLAN assignment.

### Syntax

**network-access guest-vlan** *vlan-id*

**no network-access guest-vlan**

*vlan-id* - VLAN ID (Range: 1-4094)

### Default Setting

Disabled

### Command Mode

Interface Configuration

### Command Usage

- The VLAN to be used as the guest VLAN must be defined and set as active (“vlan database” on page 4-252).
- When used with 802.1X authentication, the intrusion-action must be set for “guest-vlan” to be effective (see “dot1x intrusion-action” on page 4-141).

### Example

```
Console(config)#interface ethernet 1/1
Console(config-if)#network-access guest-vlan 25
Console(config-if)#
```

### mac-authentication reauth-time

Use this command to set the time period after which a connected MAC address must be re-authenticated. Use the **no** form of this command to restore the default value.

#### Syntax

**mac-authentication reauth-time** *seconds*  
**no mac-authentication reauth-time**

*seconds* - The reauthentication time period.  
(Range: 120-1000000 seconds)

#### Default Setting

1800

#### Command Mode

Global Configuration

#### Command Usage

- The reauthentication time is a global setting and applies to all ports.
- When the reauthentication time expires for a secure MAC address it is reauthenticated with the RADIUS server. During the reauthentication process traffic through the port remains unaffected.

#### Example

```
Console(config)#mac-authentication reauth-time 300  
Console(config)#
```

### mac-authentication intrusion-action

Use this command to configure the port response to a host MAC authentication failure. Use the **no** form of this command to restore the default.

#### Syntax

**mac-authentication intrusion-action** [**block traffic** | **pass traffic**]  
**no mac-authentication intrusion-action**

#### Default Setting

Block Traffic

#### Command Mode

Interface Config

#### Example

```
Console(config-if)#mac-authentication intrusion-action block-traffic  
Console(config-if)#
```

### mac-authentication max-mac-count

Use this command to set the maximum number of MAC addresses that can be authenticated on a port via 802.1X authentication or MAC authentication. Use the **no** form of this command to restore the default.

#### Syntax

```
mac-authentication max-mac-count count  
no mac-authentication max-mac-count
```

*count* - The maximum number of 802.1X and MAC-authenticated MAC addresses allowed. (Range: 1-1024)

#### Default Setting

1024

#### Command Mode

Interface Config

#### Example

```
Console(config-if)#mac-authentication max-mac-count 32  
Console(config-if)#
```

### clear network-access

Use this command to clear entries from the secure MAC addresses table.

#### Syntax

```
clear network-access mac-address-table [static | dynamic]  
[address mac-address] [interface interface]
```

- **static** - Specifies static address entries.
- **dynamic** - Specifies dynamic address entries.
- *mac-address* - Specifies a MAC address entry. (Format: xx-xx-xx-xx-xx-xx)
- *interface* - Specifies a port interface.
  - **ethernet** *unit/port*
    - *unit* - This is unit 1.
    - *port* - Port number. (Range: 1-28)

#### Default Setting

None

#### Command Mode

Privileged Exec

#### Example

```
Console#clear network-access mac-address-table interface ethernet 1/1  
Console#
```

### show network-access

Use this command to display the MAC authentication settings for port interfaces.

#### Syntax

**show network-access** [**interface** *interface*]

- *interface* - Specifies a port interface.
- **ethernet** *unit/port*
  - *unit* - This is unit 1.
  - *port* - Port number. (Range: 1-28)

#### Default Setting

Displays the settings for all interfaces.

#### Command Mode

Privileged Exec

#### Example

```
Console#show network-access interface ethernet 1/1
Global secure port information
Reauthentication Time           : 1800
-----
Port : 1/1
MAC Authentication              : Disabled
MAC Authentication Intrusion action : Block traffic
MAC Authentication Maximum MAC Counts : 1024
Maximum MAC Counts             : 2048
Dynamic VLAN Assignment        : Enabled
Guest VLAN                     : Disabled
Console#
```

### show network-access mac-address-table

Use this command to display secure MAC address table entries.

#### Syntax

**show network-access mac-address-table** [**static** | **dynamic**]  
[**address** *mac-address* [*mask*]] [**interface** *interface*] [**sort** {**address** | **interface**}]

- **static** - Specifies static address entries.
- **dynamic** - Specifies dynamic address entries.
- *mac-address* - Specifies a MAC address entry. (Format: xx-xx-xx-xx-xx-xx)
- *mask* - Specifies a MAC address bit mask for filtering displayed addresses.
- *interface* - Specifies a port interface.
  - **ethernet** *unit/port*
    - *unit* - This is unit 1.
    - *port* - Port number. (Range: 1-28)
- **sort** - Sorts displayed entries by either MAC address or interface.

## Default Setting

Displays all filters.

## Command Mode

Privileged Exec

## Command Usage

When using a bit mask to filter displayed MAC addresses, a 1 means “care” and a 0 means “don’t care”. For example, a MAC of 00-00-01-02-03-04 and mask FF-FF-FF-00-00-00 would result in all MACs in the range 00-00-01-00-00-00 to 00-00-01-FF-FF-FF to be displayed. All other MACs would be filtered out.

## Example

```

Console#show network-access mac-address-table
-----
Port  MAC-Address      RADIUS-Server  Attribute  Time
-----
1/1   00-00-01-02-03-04  172.155.120.17  Static     00d06h32m50s
1/1   00-00-01-02-03-05  172.155.120.17  Dynamic   00d06h33m20s
1/1   00-00-01-02-03-06  172.155.120.17  Static     00d06h35m10s
1/3   00-00-01-02-03-07  172.155.120.17  Dynamic   00d06h34m20s
Console#

```

## Web Authentication

Web authentication allows stations to authenticate and access the network in situations where 802.1X or Network Access authentication methods are infeasible or impractical. The web authentication feature allows unauthenticated hosts to request and receive a DHCP assigned IP address and perform DNS queries. All other traffic, except for http protocol traffic, is blocked. The switch intercepts http protocol traffic and redirects it to a switch-generated web page that facilitates user name and password authentication via RADIUS. Once authentication is successful, the web browser is forwarded on to the originally requested web page. Successful authentication is valid for all hosts connected to the port.

- Notes:**
1. RADIUS authentication must be activated and configured properly for the web authentication feature to work properly. (See “Configuring Local/Remote Logon Authentication” on page 3-59)
  2. Web authentication cannot be configured on trunk ports.

Table 4-44 Web Authentication

Command	Function	Mode	Page
web-auth login-attempts	Defines the limit for failed web authentication login attempts	GC	4-158
web-auth quiet-period	Defines the amount of time to wait after the limit for failed login attempts is exceeded.	GC	4-158
web-auth session-timeout	Defines the amount of time a session remains valid	GC	4-159

**Table 4-44 Web Authentication (Continued)**

Command	Function	Mode	Page
web-auth system-auth-control	Enables web authentication globally for the switch	GC	4-159
web-auth	Enables web authentication for an interface	IC	4-160
web-auth re-authenticate (Port)	Ends all web authentication sessions on the port and forces the users to re-authenticate	PE	4-160
web-auth re-authenticate (IP)	Ends the web authentication session associated with the designated IP and forces the user to re-authenticate	PE	4-160
show web-auth	Displays global web authentication parameters	PE	4-161
show web-auth interface	Displays interface-specific web authentication parameters and statistics	PE	4-162
show web-auth summary	Displays a summary of web authentication port parameters and statistics	PE	4-160

## web-auth login-attempts

This command defines the limit for failed web authentication login attempts. After the limit is reached, the switch refuses further login attempts until the quiet time expires. Use the **no** form to restore the default.

### Syntax

web-auth login-attempts *count*  
no web-auth login-attempts

*count* - The limit of allowed failed login attempts. (Range: 1-3)

### Default Setting

3 login attempts

### Command Mode

Global Configuration

### Example

```
Console(config)#web-auth login-attempts 2
Console(config)#
```

## web-auth quiet-period

This command defines the amount of time a host must wait after exceeding the limit for failed login attempts, before it may attempt web authentication again. Use the **no** form to restore the default.

### Syntax

web-auth quiet-period *time*  
no web-auth quiet period

*time* - The amount of time the host must wait before attempting authentication again. (Range: 1-180 seconds)



**Default Setting**

60 seconds

**Command Mode**

Global Configuration

**Example**

```
Console(config)#web-auth quiet-period 120
Console(config)#
```

**web-auth session-timeout**

This command defines the amount of time a web-authentication session remains valid. When the session-timeout has been reached, the host is logged off and must re-authenticate itself the next time data is transmitted. Use the **no** form to restore the default.

**Syntax**

**web-auth session-timeout** *timeout*  
**no web-auth session timeout**

*timeout* - The amount of time that an authenticated session remains valid.  
(Range: 300-3600 seconds)

**Default Setting**

3600 seconds

**Command Mode**

Global Configuration

**Example**

```
Console(config)#web-auth session-timeout 1800
Console(config)#
```

**web-auth system-auth-control**

This command globally enables web authentication for the switch. Use the no form to restore the default.

**Syntax**

[no] **web-auth system-auth-control**

**Default Setting**

Disabled

**Command Mode**

Global Configuration

**Command Usage**

Both **web-auth system-auth-control** for the switch and **web-auth** for an interface must be enabled for the web authentication feature to be active.

### Example

```
Console(config)#web-auth system-auth-control  
Console(config)#
```

### web-auth

This command enables web authentication for a port. Use the no form to restore the default.

### Syntax

[no] **web-auth**

### Default Setting

Disabled

### Command Mode

Interface Configuration

### Command Usage

Both **web-auth system-auth-control** for the switch and **web-auth** for a port must be enabled for the web authentication feature to be active.

### Example

```
Console(config-if)#web-auth  
Console(config-if)#
```

### web-auth re-authenticate (Port)

This command ends all web authentication sessions connected to the port and forces the users to re-authenticate.

### Syntax

**web-auth re-authenticate interface** *interface*

- *interface* - Specifies a port interface.
- **ethernet unit/port**
  - *unit* - This is unit 1.
  - *port* - Port number. (Range: 1-28)

### Default Setting

None

### Command Mode

Privileged Exec

### Example

```
Console#web-auth re-authenticate interface ethernet 1/2  
Failed to reauth .  
Console#
```

**web-auth re-authenticate (IP)**

This command ends the web authentication session associated with the designated IP address and forces the user to re-authenticate.

**Syntax**

**web-auth re-authenticate interface** *interface ip*

- *interface* - Specifies a port interface.
  - **ethernet unit/port**
    - *unit* - This is unit 1.
    - *port* - Port number. (Range: 1-28)
- *ip* - IPv4 formatted IP address

**Default Setting**

None

**Command Mode**

Privileged Exec

**Example**

```
Console#web-auth re-authenticate interface ethernet 1/2 192.168.1.5
Failed to reauth port.
Console#
```

**show web-auth**

This command displays global web authentication parameters.

**Syntax**

**show web-auth**

**Default Setting**

None

**Command Mode**

Privileged Exec

**Example**

```
Console#show web-auth

Global Web-Auth Parameters

System Auth Control      : Enabled
Session Timeout         : 3600
Quiet Period            : 60
Max Login Attempts      : 3
Console#
```

### show web-auth interface

This command displays interface-specific web authentication parameters and statistics.

#### Syntax

**show web-auth interface** *interface*

- *interface* - Specifies a port interface.
  - **ethernet** *unit/port*
    - *unit* - This is unit 1.
    - *port* - Port number. (Range: 1-28)

#### Default Setting

None

#### Command Mode

Privileged Exec

#### Command Usage

The session timeout displayed by this command is expressed in seconds.

#### Example

```
Console#show web-auth interface ethernet 1/2
Web Auth Status      : Enabled

Host Summary

IP address           Web-Auth-State Remaining-Session-Time
-----
1.1.1.1              Authenticated   295
1.1.1.2              Authenticated   111
Console#
```

## show web-auth summary

This command displays a summary of web authentication port parameters and statistics.

### Command Mode

Privileged Exec

### Example

```

Console#show web-auth summary

Global Web-Auth Parameters

  System Auth Control      : Enabled
Port      Status           Authenticated Host Count
-----
1/ 1      Disabled            0
1/ 2      Enabled              8
1/ 3      Disabled            0
1/ 4      Disabled            0
1/ 5      Disabled            0
:
:

```

## DHCP Snooping Commands

DHCP snooping allows a switch to protect a network from rogue DHCP servers or other devices which send port-related information to a DHCP server. This information can be useful in tracking an IP address back to a physical port. This section describes commands used to configure DHCP snooping.

Table 4-45 DHCP Snooping Commands

Command	Function	Mode	Page
ip dhcp snooping	Enables DHCP snooping globally	GC	4-164
ip dhcp snooping vlan	Enables DHCP snooping on the specified VLAN	GC	4-165
ip dhcp snooping trust	Configures the specified interface as trusted	IC	4-166
ip dhcp snooping verify mac-address	Verifies the client's hardware address stored in the DHCP packet against the source MAC address in the Ethernet header	GC	4-167
ip dhcp snooping information option	Enables or disables DHCP Option 82 information relay	GC	4-168
ip dhcp snooping information policy	Sets the information option policy for DHCP client packets that include Option 82 information	GC	4-169
ip dhcp snooping database flash	Writes all dynamically learned snooping entries to flash memory	PE	4-169
clear ip dhcp snooping database flash	Removes all dynamically learned snooping entries from flash memory.	PE	4-170
show ip dhcp snooping	Shows the DHCP snooping configuration settings	PE	4-170
show ip dhcp snooping binding	Shows the DHCP snooping binding table entries	PE	4-170

### ip dhcp snooping

This command enables DHCP snooping globally. Use the **no** form to restore the default setting.

#### Syntax

[no] ip dhcp snooping

#### Default Setting

Disabled

#### Command Mode

Global Configuration

#### Command Usage

- Network traffic may be disrupted when malicious DHCP messages are received from an outside source. DHCP snooping is used to filter DHCP messages received on an unsecure interface from outside the network or firewall. When DHCP snooping is enabled globally by this command, and enabled on a VLAN interface by the **ip dhcp snooping vlan** command (page 4-165), DHCP messages received on an untrusted interface (as specified by the **no ip dhcp snooping trust** command, page 4-166) from a device not listed in the DHCP snooping table will be dropped.
- When enabled, DHCP messages entering an untrusted interface are filtered based upon dynamic entries learned via DHCP snooping.
- Table entries are only learned for untrusted interfaces. Each entry includes a MAC address, IP address, lease time, VLAN identifier, and port identifier.
- When DHCP snooping is enabled, the rate limit for the number of DHCP messages that can be processed by the switch is 100 packets per second. Any DHCP packets in excess of this limit are dropped.
- Filtering rules are implemented as follows:
  - If global DHCP snooping is disabled, all DHCP packets are forwarded.
  - If DHCP snooping is enabled globally, and also enabled on the VLAN where the DHCP packet is received, all DHCP packets are forwarded for a *trusted* port. If the received packet is a DHCP ACK message, a dynamic DHCP snooping entry is also added to the binding table.
  - If DHCP snooping is enabled globally, and also enabled on the VLAN where the DHCP packet is received, but the port is *not trusted*, it is processed as follows:
    - \* If the DHCP packet is a reply packet from a DHCP server (including OFFER, ACK or NAK messages), the packet is dropped.
    - \* If the DHCP packet is from a client, such as a DECLINE or RELEASE message, the switch forwards the packet only if the corresponding entry is found in the binding table.
    - \* If the DHCP packet is from client, such as a DISCOVER, REQUEST, INFORM, DECLINE or RELEASE message, the packet is forwarded if MAC address verification is disabled (as specified by the **ip dhcp snooping verify mac-address** command, page 4-167). However, if

MAC address verification is enabled, then the packet will only be forwarded if the client's hardware address stored in the DHCP packet is the same as the source MAC address in the Ethernet header.

- \* If the DHCP packet is not a recognizable type, it is dropped.
- If a DHCP packet from a client passes the filtering criteria above, it will only be forwarded to trusted ports in the same VLAN.
- If a DHCP packet from a server is received on a trusted port, it will be forwarded to both trusted and untrusted ports in the same VLAN.
- If the DHCP snooping is globally disabled, all dynamic bindings are removed from the binding table.
- *Additional considerations when the switch itself is a DHCP client* – The port(s) through which the switch submits a client request to the DHCP server must be configured as trusted (**ip dhcp snooping trust**, page 4-166). Note that the switch will not add a dynamic entry for itself to the binding table when it receives an ACK message from a DHCP server. Also, when the switch sends out DHCP client packets for itself, no filtering takes place. However, when the switch receives any messages from a DHCP server, any packets received from untrusted ports are dropped.

### Example

This example enables DHCP snooping globally for the switch.

```
Console(config)#ip dhcp snooping
Console(config)#
```

### Related Commands

- ip dhcp snooping vlan (4-165)
- ip dhcp snooping trust (4-166)

### ip dhcp snooping vlan

This command enables DHCP snooping on the specified VLAN. Use the **no** form to restore the default setting.

### Syntax

```
[no] ip dhcp snooping vlan vlan-id
```

*vlan-id* - ID of a configured VLAN (Range: 1-4094)

### Default Setting

Disabled

### Command Mode

Global Configuration

### Command Usage

- When DHCP snooping enabled globally using the **ip dhcp snooping** command (page 4-164), and enabled on a VLAN with this command, DHCP

## 4 Command Line Interface

packet filtering will be performed on any untrusted ports within the VLAN as specified by the **ip dhcp snooping trust** command (page 4-166).

- When the DHCP snooping is globally disabled, DHCP snooping can still be configured for specific VLANs, but the changes will not take effect until DHCP snooping is globally re-enabled.
- When DHCP snooping is globally enabled, configuration changes for specific VLANs have the following effects:
  - If DHCP snooping is disabled on a VLAN, all dynamic bindings learned for this VLAN are removed from the binding table.

### Example

This example enables DHCP snooping for VLAN 1.

```
Console(config)#ip dhcp snooping vlan 1
Console(config)#
```

### Related Commands

- ip dhcp snooping (4-164)
- ip dhcp snooping trust (4-166)

### ip dhcp snooping trust

This command configures the specified interface as trusted. Use the **no** form to restore the default setting.

### Syntax

[no] ip dhcp snooping trust

### Default Setting

All interfaces are untrusted

### Command Mode

Interface Configuration (Ethernet, Port Channel)

### Command Usage

- A trusted interface is an interface that is configured to receive only messages from within the network. An untrusted interface is an interface that is configured to receive messages from outside the network or firewall.
- Set all ports connected to DHCP servers within the local network or firewall to trusted, and all other ports outside the local network or firewall to untrusted.
- When DHCP snooping is enabled globally using the **ip dhcp snooping** command (page 4-164), and enabled on a VLAN with **ip dhcp snooping vlan** command (page 4-165), DHCP packet filtering will be performed on any untrusted ports within the VLAN according to the default status, or as specifically configured for an interface with the **no ip dhcp snooping trust** command.
- When an untrusted port is changed to a trusted port, all the dynamic DHCP snooping bindings associated with this port are removed.



- *Additional considerations when the switch itself is a DHCP client* – The port(s) through which it submits a client request to the DHCP server must be configured as trusted.

### Example

This example sets port 5 to untrusted.

```
Console(config)#interface ethernet 1/5
Console(config-if)#no ip dhcp snooping trust
Console(config-if)#
```

### Related Commands

- ip dhcp snooping (4-164)
- ip dhcp snooping vlan (4-165)

### ip dhcp snooping verify mac-address

This command verifies the client's hardware address stored in the DHCP packet against the source MAC address in the Ethernet header. Use the **no** form to disable this function.

### Syntax

[no] ip dhcp snooping verify mac-address

### Default Setting

Enabled

### Command Mode

Global Configuration

### Command Usage

If MAC address verification is enabled, and the source MAC address in the Ethernet header of the packet is not same as the client's hardware address in the DHCP packet, the packet is dropped.

### Example

This example enables MAC address verification.

```
Console(config)#ip dhcp snooping verify mac-address
Console(config)#
```

### Related Commands

- ip dhcp snooping (4-164)
- ip dhcp snooping vlan (4-165)
- ip dhcp snooping trust (4-166)

### ip dhcp snooping information option

This command enables the DHCP Option 82 information relay for the switch. Use the **no** form to disable this function.

#### Syntax

**[no] ip dhcp snooping information option**

#### Default Setting

Disabled

#### Command Mode

Global Configuration

#### Command Usage

- DHCP provides a relay mechanism for sending information about the switch and its DHCP clients to the DHCP server. Known as DHCP Option 82, it allows compatible DHCP servers to use the information when assigning IP addresses, or to set other services or policies for clients.
- When the DHCP Snooping Information Option is enabled, the requesting client (or an intermediate relay agent that has used the information fields to describe itself) can be identified in the DHCP request packets forwarded by the switch and in reply packets sent back from the DHCP server by the switch port to which they are connected rather than just their MAC address. DHCP client-server exchange messages are then forwarded directly between the server and client without having to flood them to the entire VLAN.
- DHCP snooping must be enabled on the switch for the DHCP Option 82 information to be inserted into packets.
- Use the **ip dhcp snooping information option** command (page 4-168) to specify how to handle DHCP client request packets which already contain Option 82 information.

#### Example

This example enables the DHCP Snooping Information Option.

```
Console(config)#ip dhcp snooping information option
Console(config)#
```

## ip dhcp snooping information policy

This command sets the DHCP snooping information option policy for DHCP client packets that include Option 82 information.

### Syntax

**ip dhcp snooping information policy {drop | keep | replace}**

- **drop** - Drops the client's request packet instead of relaying it.
- **keep** - Retains the Option 82 information in the client request, and forwards the packets to trusted ports.
- **replace** - Replaces the Option 82 information in the client's request with information about the relay agent itself, inserts the relay agent's address (when DHCP snooping is enabled), and forwards the packets to trusted ports.

### Default Setting

replace

### Command Mode

Global Configuration

### Command Usage

When the switch receives DHCP packets from clients that already include DHCP Option 82 information, the switch can be configured to set the action policy for these packets. The switch can either drop the DHCP packets, keep the existing information, or replace it with the switch's relay information.

### Example

```
Console(config)#ip dhcp snooping information policy drop
Console(config)#
```

## ip dhcp snooping database flash

This command writes all dynamically learned snooping entries to flash memory.

### Command Mode

Privileged Exec

### Command Usage

This command can be used to store the currently learned dynamic DHCP snooping entries to flash memory. These entries will be restored to the snooping table when the switch is reset. However, note that the lease time shown for a dynamic entry that has been restored from flash memory will no longer be valid.

### Example

```
Console(config)#ip dhcp snooping database flash
Console(config)#
```

### clear ip dhcp snooping database flash

This command removes all dynamically learned snooping entries from flash memory.

#### Command Mode

Privileged Exec

#### Example

```
Console(config)#ip dhcp snooping database flash
Console(config)#
```

### show ip dhcp snooping

This command shows the DHCP snooping configuration settings.

#### Command Mode

Privileged Exec

#### Example

```
Console#show ip dhcp snooping
Global DHCP Snooping status: disable
DHCP Snooping Information Option Status: disable
DHCP Snooping Information Policy: replace
DHCP Snooping is configured on the following VLANs:
1
Verify Source Mac-Address: enable
Interface          Trusted
-----
Eth 1/1            No
Eth 1/2            No
Eth 1/3            No
Eth 1/4            No
Eth 1/5            Yes
:
```

### show ip dhcp snooping binding

This command shows the DHCP snooping binding table entries.

#### Command Mode

Privileged Exec

#### Example

```
Console#show ip dhcp snooping binding
MacAddress      IPAddress      Lease(sec)  Type           VLAN  Interface
-----
11-22-33-44-55-66  192.168.0.99      0  Static           1    Eth 1/5
Console#
```

## IP Source Guard Commands

IP Source Guard is a security feature that filters IP traffic on network interfaces based on manually configured entries in the IP Source Guard table, or static and dynamic entries in the DHCP Snooping table when enabled (see “DHCP Snooping Commands” on page 4-163). IP source guard can be used to prevent traffic attacks caused when a host tries to use the IP address of a neighbor to access the network. This section describes commands used to configure IP Source Guard.

**Table 4-46 IP Source Guard Commands**

Command	Function	Mode	Page
ip source-guard	Configures the switch to filter inbound traffic based on source IP address, or source IP address and corresponding MAC address	IC	4-171
ip source-guard binding	Adds a static address to the source-guard binding table	GC	4-173
show ip source-guard	Shows whether source guard is enabled or disabled on each interface	PE	4-174
show ip source-guard binding	Shows the source guard binding table	PE	4-174

### ip source-guard

This command configures the switch to filter inbound traffic based source IP address, or source IP address and corresponding MAC address. Use the **no** form to disable this function.

#### Syntax

```
ip source-guard {sip | sip-mac}
no ip source-guard
```

- **sip** - Filters traffic based on IP addresses stored in the binding table.
- **sip-mac** - Filters traffic based on IP addresses and corresponding MAC addresses stored in the binding table.

#### Default Setting

Disabled

#### Command Mode

Interface Configuration (Ethernet)

#### Command Usage

- Source guard is used to filter traffic on an unsecure port which receives messages from outside the network or firewall, and therefore may be subject to traffic attacks caused by a host trying to use the IP address of a neighbor.
- Setting source guard mode to “sip” or “sip-mac” enables this function on the selected port. Use the “sip” option to check the VLAN ID, source IP address, and port number against all entries in the binding table. Use the “sip-mac” option to check these same parameters, plus the source MAC address. Use the **no source guard** command to disable this function on the selected port.

## 4 Command Line Interface

- When enabled, traffic is filtered based upon dynamic entries learned via DHCP snooping, or static addresses configured in the source guard binding table.
- Table entries include a MAC address, IP address, lease time, entry type (Static-IP-SG-Binding, Dynamic-DHCP-Binding, VLAN identifier, and port identifier).
- Static addresses entered in the source guard binding table with the **ip source-guard binding** command (page 4-173) are automatically configured with an infinite lease time. Dynamic entries learned via DHCP snooping are configured by the DHCP server itself; static entries include a manually configured lease time.
- If the IP source guard is enabled, an inbound packet's IP address (sip option) or both its IP address and corresponding MAC address (sip-mac option) will be checked against the binding table. If no matching entry is found, the packet will be dropped.
- Filtering rules are implemented as follows:
  - If DHCP snooping is disabled (see page 4-164), IP source guard will check the VLAN ID, source IP address, port number, and source MAC address (for the sip-mac option). If a matching entry is found in the binding table and the entry type is static IP source guard binding, the packet will be forwarded.
  - If the DHCP snooping is enabled, IP source guard will check the VLAN ID, source IP address, port number, and source MAC address (for the sip-mac option). If a matching entry is found in the binding table and the entry type is static IP source guard binding, or dynamic DHCP snooping binding, the packet will be forwarded.
  - If IP source guard is enabled on an interface for which IP source bindings (dynamically learned via DHCP snooping or manually configured) are not yet configured, the switch will drop all IP traffic on that port, except for DHCP packets.

### Example

This example enables IP source guard on port 5.

```
Console(config)#interface ethernet 1/5
Console(config-if)#ip source-guard sip
Console(config-if)#
```

### Related Commands

- ip source-guard binding (4-173)
- ip dhcp snooping (4-164)
- ip dhcp snooping vlan (4-165)

## ip source-guard binding

This command adds a static address to the source-guard binding table. Use the **no** form to remove a static entry.

### Syntax

```
ip source-guard binding mac-address vlan vlan-id ip-address  
interface ethernet unit/port  
no ip source-guard binding mac-address vlan vlan-id
```

- *mac-address* - A valid unicast MAC address.
- *vlan-id* - ID of a configured VLAN (Range: 1-4094)
- *ip-address* - A valid unicast IP address, including classful types A, B or C.
- *unit* - Stack unit. (Range: 1)
- *port* - Port number. (Range: 1-28)

### Default Setting

No configured entries

### Command Mode

Global Configuration

### Command Usage

- Table entries include a MAC address, IP address, lease time, entry type (Static-IP-SG-Binding, Dynamic-DHCP-Binding, VLAN identifier, and port identifier).
- All static entries are configured with an infinite lease time, which is indicated with a value of zero by the **show ip source-guard** command (page 4-174).
- When source guard is enabled, traffic is filtered based upon dynamic entries learned via DHCP snooping, or static addresses configured in the source guard binding table with this command.
- Static bindings are processed as follows:
  - If there is no entry with same VLAN ID and MAC address, a new entry is added to binding table using the type of static IP source guard binding.
  - If there is an entry with same VLAN ID and MAC address, and the type of entry is static IP source guard binding, then the new entry will replace the old one.
  - If there is an entry with same VLAN ID and MAC address, and the type of the entry is dynamic DHCP snooping binding, then the new entry will replace the old one and the entry type will be changed to static IP source guard binding.

### Example

This example configures a static source-guard binding on port 5.

```
Console(config)#ip source-guard binding 11-22-33-44-55-66 vlan 1  
192.168.0.99 interface ethernet 1/5  
Console(config-if)#
```

## Related Commands

- ip source-guard (4-171)
- ip dhcp snooping (4-164)
- ip dhcp snooping vlan (4-165)

## show ip source-guard

This command shows whether source guard is enabled or disabled on each interface.

## Command Mode

Privileged Exec

## Example

```
Console#show ip source-guard
Interface    Filter-type
-----
Eth 1/1     DISABLED
Eth 1/2     DISABLED
Eth 1/3     DISABLED
Eth 1/4     DISABLED
Eth 1/5     SIP
Eth 1/6     DISABLED
:
```

## show ip source-guard binding

This command shows the source guard binding table.

## Syntax

**show ip source-guard binding [dhcp-snooping | static]**

- dhcp-snooping** - Shows dynamic entries configured with DHCP Snooping commands (see page 4-163)
- static** - Shows static entries configured with the **ip source-guard binding** command (see page 4-173).

## Command Mode

Privileged Exec

## Example

```
Console#show ip source-guard binding
MacAddress      IpAddress      Lease(sec)  Type           VLAN  Interface
-----
11-22-33-44-55-66  192.168.0.99      0  Static           1    Eth 1/5
Console#
```



## Access Control List Commands

Access Control Lists (ACL) provide packet filtering for IP frames (based on address, protocol, or Layer 4 protocol port number or TCP control code) or any frames (based on MAC address or Ethernet type). To filter packets, first create an access list, add the required rules and then bind the list to a specific port. This section describes the Access Control List commands.

**Table 4-47 Access Control Lists**

Command Groups	Function	Page
IP ACLs	Configures ACLs based on IP addresses, TCP/UDP port number, and protocol type	4-175
MAC ACLs	Configures ACLs based on hardware addresses, packet format, and Ethernet type	4-181
ACL Information	Displays ACLs and associated rules; shows ACLs assigned to each port	4-186

### IP ACLs

The commands in this section configure ACLs based on IP addresses, TCP/UDP port number, protocol type, and TCP control code. To configure IP ACLs, first create an access list containing the required permit or deny rules, and then bind the access list to one or more ports.

**Table 4-48 IP ACLs**

Command	Function	Mode	Page
access-list ip	Creates an IP ACL and enters configuration mode for standard or extended IP ACLs	GC	4-176
permit, deny	Filters packets matching a specified source IP address	STD-ACL	4-177
permit, deny	Filters packets meeting the specified criteria, including source and destination IP address, TCP/UDP port number, protocol type, and TCP control code	EXT-ACL	4-178
show ip access-list	Displays the rules for configured IP ACLs	PE	4-180
ip access-group	Adds a port to an IP ACL	IC	4-180
show ip access-group	Shows port assignments for IP ACLs	PE	4-180

### access-list ip

This command adds an IP access list and enters configuration mode for standard or extended IP ACLs. Use the **no** form to remove the specified ACL.

#### Syntax

**[no] access-list ip {standard | extended} *acl\_name***

- **standard** – Specifies an ACL that filters packets based on the source IP address.
- **extended** – Specifies an ACL that filters packets based on the source or destination IP address, and other more specific criteria.
- *acl\_name* – Name of the ACL. (Maximum length: 16 characters, no spaces)

#### Default Setting

None

#### Command Mode

Global Configuration

#### Command Usage

- When you create a new ACL or enter configuration mode for an existing ACL, use the **permit** or **deny** command to add new rules to the bottom of the list. To create an ACL, you must add at least one rule to the list.
- To remove a rule, use the **no permit** or **no deny** command followed by the exact text of a previously configured rule.
- An ACL can contain up to 100 rules.

#### Example

```
Console(config)#access-list ip standard david
Console(config-std-acl)#
```

#### Related Commands

permit, deny 4-177  
ip access-group (4-180)  
show ip access-list (4-180)

## permit, deny (Standard ACL)

This command adds a rule to a Standard IP ACL. The rule sets a filter condition for packets emanating from the specified source. Use the **no** form to remove a rule.

### Syntax

```
[no] {permit | deny} {any | source bitmask | host source}
```

- **any** – Any source IP address.
- **source** – Source IP address.
- **bitmask** – Decimal number representing the address bits to match.
- **host** – Keyword followed by a specific IP address.

### Default Setting

None

### Command Mode

Standard ACL

### Command Usage

- New rules are appended to the end of the list.
- Address bitmasks are similar to a subnet mask, containing four integers from 0 to 255, each separated by a period. The binary mask uses 1 bits to indicate “match” and 0 bits to indicate “ignore.” The bitmask is bitwise ANDed with the specified source IP address, and then compared with the address for each IP packet entering the port(s) to which this ACL has been assigned.

### Example

This example configures one permit rule for the specific address 10.1.1.21 and another rule for the address range 168.92.16.x – 168.92.31.x using a bitmask.

```
Console(config-std-acl)#permit host 10.1.1.21
Console(config-std-acl)#permit 168.92.16.0 255.255.240.0
```

### Related Commands

access-list ip (4-176)

### permit, deny (Extended ACL)

This command adds a rule to an Extended IP ACL. The rule sets a filter condition for packets with specific source or destination IP addresses, protocol types, source or destination protocol ports, or TCP control codes. Use the **no** form to remove a rule.

#### Syntax

```
[no] {permit | deny} [protocol-number | udp]
    {any | source address-bitmask | host source}
    {any | destination address-bitmask | host destination}
    [precedence precedence] [dscp dscp]
    [source-port sport [bitmask]] [destination-port dport [port-bitmask]]
```

```
[no] {permit | deny} tcp
    {any | source address-bitmask | host source}
    {any | destination address-bitmask | host destination}
    [precedence precedence] [dscp dscp]
    [source-port sport [bitmask]] [destination-port dport [port-bitmask]]
    [control-flag control-flags flag-bitmask]
```

- *protocol-number* – A specific protocol number. (Range: 0-255)
- *source* – Source IP address.
- *destination* – Destination IP address.
- *address-bitmask* – Decimal number representing the address bits to match.
- **host** – Keyword followed by a specific IP address.
- *precedence* – IP precedence level. (Range: 0-7)
- *dscp* – DSCP priority level. (Range: 0-63)
- *sport* – Protocol<sup>25</sup> source port number. (Range: 0-65535)
- *dport* – Protocol<sup>25</sup> destination port number. (Range: 0-65535)
- *port-bitmask* – Decimal number representing the port bits to match. (Range: 0-65535)
- *control-flags* – Decimal number (representing a bit string) that specifies flag bits in byte 14 of the TCP header. (Range: 0-63)
- *flag-bitmask* – Decimal number representing the code bits to match.

#### Default Setting

None

#### Command Mode

Extended ACL

#### Command Usage

- All new rules are appended to the end of the list.
- Address bitmasks are similar to a subnet mask, containing four integers from 0 to 255, each separated by a period. The binary mask uses 1 bits to indicate

---

<sup>25</sup>. Includes TCP, UDP or other protocol types.

“match” and 0 bits to indicate “ignore.” The bitmask is bitwise ANDed with the specified source IP address, and then compared with the address for each IP packet entering the port(s) to which this ACL has been assigned.

- The control-code bitmask is a decimal number (representing an equivalent bit mask) that is applied to the control code. Enter a decimal number, where the equivalent binary bit “1” means to match a bit and “0” means to ignore a bit. The following bits may be specified:
  - 1 (fin) – Finish
  - 2 (syn) – Synchronize
  - 4 (rst) – Reset
  - 8 (psh) – Push
  - 16 (ack) – Acknowledgement
  - 32 (urg) – Urgent pointer

For example, use the code value and mask below to catch packets with the following flags set:

- SYN flag valid, use “control-code 2 2”
- Both SYN and ACK valid, use “control-code 18 18”
- SYN valid and ACK invalid, use “control-code 2 18”

### Example

This example accepts any incoming packets if the source address is within subnet 10.7.1.x. For example, if the rule is matched; i.e., the rule (10.7.1.0 & 255.255.255.0) equals the masked address (10.7.1.2 & 255.255.255.0), the packet passes through.

```
Console(config-ext-acl)#permit 10.7.1.1 255.255.255.0 any
Console(config-ext-acl)#
```

This allows TCP packets from class C addresses 192.168.1.0 to any destination address when set for destination TCP port 80 (i.e., HTTP).

```
Console(config-ext-acl)#permit 192.168.1.0 255.255.255.0 any
destination-port 80
Console(config-ext-acl)#
```

This permits all TCP packets from class C addresses 192.168.1.0 with the TCP control code set to “SYN.”

```
Console(config-ext-acl)#permit tcp 192.168.1.0 255.255.255.0 any
control-flag 2 2
Console(config-ext-acl)#
```

### Related Commands

access-list ip (4-176)

## 4 Command Line Interface

### show ip access-list

This command displays the rules for configured IP ACLs.

#### Syntax

```
show ip access-list {standard | extended} [acl_name]
```

- **standard** – Specifies a standard IP ACL.
- **extended** – Specifies an extended IP ACL.
- **acl\_name** – Name of the ACL. (Maximum length: 16 characters, no spaces)

#### Command Mode

Privileged Exec

#### Example

```
Console#show ip access-list standard
IP standard access-list david:
  permit host 10.1.1.21
  permit 168.92.0.0 255.255.255.0
Console#
```

#### Related Commands

permit, deny 4-177  
ip access-group (4-180)

### ip access-group

This command binds a port to an IP ACL. Use the **no** form to remove the port.

#### Syntax

```
[no] ip access-group acl_name in
```

- **acl\_name** – Name of the ACL. (Maximum length: 16 characters, no spaces)
- **in** – Indicates that this list applies to ingress packets.

#### Default Setting

None

#### Command Mode

Interface Configuration (Ethernet)

#### Command Usage

- A port can only be bound to one ACL.
- If a port is already bound to an ACL and you bind it to a different ACL, the switch will replace the old binding with the new one.

**Example**

```
Console(config)#int eth 1/25
Console(config-if)#ip access-group david in
Console(config-if)#
```

**Related Commands**

show ip access-list (4-180)

**show ip access-group**

This command shows the ports assigned to IP ACLs.

**Command Mode**

Privileged Exec

**Example**

```
Console#show ip access-group
Interface ethernet 1/25
 IP access-list david in
Console#
```

**Related Commands**

ip access-group (4-180)

**MAC ACLs**

The commands in this section configure ACLs based on hardware addresses, packet format, and Ethernet type. To configure MAC ACLs, first create an access list containing the required permit or deny rules, and then bind the access list to one or more ports.

**Table 4-49 MAC ACL Commands**

Command	Function	Mode	Page
access-list mac	Creates a MAC ACL and enters configuration mode	GC	4-182
permit, deny	Filters packets matching a specified source and destination address, packet format, and Ethernet type	MAC-ACL	4-183
show mac access-list	Displays the rules for configured MAC ACLs	PE	4-184
mac access-group	Adds a port to a MAC ACL	IC	4-185
show mac access-group	Shows port assignments for MAC ACLs	PE	4-185

### access-list mac

This command adds a MAC access list and enters MAC ACL configuration mode. Use the **no** form to remove the specified ACL.

#### Syntax

**[no] access-list mac *acl\_name***

*acl\_name* – Name of the ACL. (Maximum length: 16 characters)

#### Default Setting

None

#### Command Mode

Global Configuration

#### Command Usage

- When you create a new ACL or enter configuration mode for an existing ACL, use the **permit** or **deny** command to add new rules to the bottom of the list. To create an ACL, you must add at least one rule to the list.
- To remove a rule, use the **no permit** or **no deny** command followed by the exact text of a previously configured rule.
- An ACL can contain up to 32 rules.

#### Example

```
Console(config)#access-list mac jerry
Console(config-mac-acl)#
```

#### Related Commands

permit, deny (4-183)

mac access-group (4-185)

show mac access-list (4-184)



**permit, deny (MAC ACL)**

This command adds a rule to a MAC ACL. The rule filters packets matching a specified MAC source or destination address (i.e., physical layer address), or Ethernet protocol type. Use the **no** form to remove a rule.

**Syntax**

```
[no] {permit | deny}
      {any | host source | source address-bitmask}
      {any | host destination | destination address-bitmask}
      [cos cos cos-bitmask] [vid vid vid-bitmask]
      [etherstype protocol [protocol-bitmask]]
```

**Note:** The default is for Ethernet II packets.

```
[no] {permit | deny} tagged-eth2
      {any | host source | source address-bitmask}
      {any | host destination | destination address-bitmask}
      [cos cos cos-bitmask] [vid vid vid-bitmask]
      [etherstype protocol [protocol-bitmask]]
```

```
[no] {permit | deny} untagged-eth2
      {any | host source | source address-bitmask}
      {any | host destination | destination address-bitmask}
      [etherstype protocol [protocol-bitmask]]
```

```
[no] {permit | deny} tagged-802.3
      {any | host source | source address-bitmask}
      {any | host destination | destination address-bitmask}
      [cos cos cos-bitmask] [vid vid vid-bitmask]
```

```
[no] {permit | deny} untagged-802.3
      {any | host source | source address-bitmask}
      {any | host destination | destination address-bitmask}
```

- **tagged-eth2** – Tagged Ethernet II packets.
- **untagged-eth2** – Untagged Ethernet II packets.
- **tagged-802.3** – Tagged Ethernet 802.3 packets.
- **untagged-802.3** – Untagged Ethernet 802.3 packets.
- **any** – Any MAC source or destination address.
- **host** – A specific MAC address.
- *source* – Source MAC address.
- *destination* – Destination MAC address range with bitmask.
- *address-bitmask*<sup>26</sup> – Bitmask for MAC address (in hexadecimal format).
- **cos** – Class-of-Service value (Range: 0-7)
- *cos-bitmask* – Class-of-Service bitmask. (Range: Range: 0-7)
- *vid* – VLAN ID. (Range: 1-4094)
- *vid-bitmask* – VLAN bitmask. (Range: 1-4095)

26. For all bitmasks, “1” means care and “0” means ignore.

## 4 Command Line Interface

- *protocol* – A specific Ethernet protocol number. (Range: 600-fff hex.)
- *protocol-bitmask* – Protocol bitmask. (Range: 600-fff hex.)

### Default Setting

None

### Command Mode

MAC ACL

### Command Usage

- New rules are added to the end of the list.
- The **ethertype** option can only be used to filter Ethernet II formatted packets.
- A detailed listing of Ethernet protocol types can be found in RFC 1060. A few of the more common types include the following:
  - 0800 - IP
  - 0806 - ARP
  - 8137 - IPX

### Example

This rule permits packets from any source MAC address to the destination address 00-e0-29-94-34-de where the Ethernet type is 0800.

```
Console(config-mac-acl)#permit any host 00-e0-29-94-34-de ethertype 0800
Console(config-mac-acl)#
```

### Related Commands

access-list mac (4-182)

### show mac access-list

This command displays the rules for configured MAC ACLs.

### Syntax

```
show mac access-list [acl_name]
```

*acl\_name* – Name of the ACL. (Maximum length: 16 characters)

### Command Mode

Privileged Exec

### Example

```
Console#show mac access-list
MAC access-list jerry:
  permit any 00-e0-29-94-34-de ethertype 0800
Console#
```

### Related Commands

permit, deny 4-183  
mac access-group (4-185)

**mac access-group**

This command binds a port to a MAC ACL. Use the **no** form to remove the port.

**Syntax**

**mac access-group** *acl\_name* **in**

- *acl\_name* – Name of the ACL. (Maximum length: 16 characters)
- **in** – Indicates that this list applies to ingress packets.

**Default Setting**

None

**Command Mode**

Interface Configuration (Ethernet)

**Command Usage**

- A port can only be bound to one ACL.
- If a port is already bound to an ACL and you bind it to a different ACL, the switch will replace the old binding with the new one.

**Example**

```
Console(config)#interface ethernet 1/2
Console(config-if)#mac access-group jerry in
Console(config-if)#
```

**Related Commands**

show mac access-list (4-184)

**show mac access-group**

This command shows the ports assigned to MAC ACLs.

**Command Mode**

Privileged Exec

**Example**

```
Console#show mac access-group
Interface ethernet 1/5
  MAC access-list M5 in
Console#
```

**Related Commands**

mac access-group (4-185)

## ACL Information

**Table 4-50 ACL Information**

Command	Function	Mode	Page
show access-list	Show all ACLs and associated rules	PE	4-186
show access-group	Shows the ACLs assigned to each port	PE	4-186

### show access-list

This command shows all ACLs and associated rules, as well as all the user-defined masks.

### Command Mode

Privileged Exec

### Example

```
Console#show access-list
IP standard access-list david:
  permit host 10.1.1.21
  permit 168.92.16.0 255.255.240.0
IP extended access-list bob:
  permit 10.7.1.1 255.255.255.0 any
  permit 192.168.1.0 255.255.255.0 any destination-port 80 80
  permit 192.168.1.0 255.255.255.0 any protocol tcp control-code 2 2
IP access-list jerry:
  permit any host 00-30-29-94-34-de ethertype 800 800
IP extended access-list A6:
  deny tcp any any control-flag 2 2
  permit any any
Console#
```

### show access-group

This command shows the port assignments of ACLs.

### Command Mode

Privileged Executive

### Example

```
Console#show access-group
Interface ethernet 1/1
  IP access-list jerry in
:
Interface ethernet 1/28
  IP access-list jerry in
Console#
```

## Interface Commands

These commands are used to display or set communication parameters for an Ethernet port, aggregated link, or VLAN.

**Table 4-51 Interface Commands**

Command	Function	Mode	Page
interface	Configures an interface type and enters interface configuration mode	GC	4-187
description	Adds a description to an interface configuration	IC	4-188
speed-duplex	Configures the speed and duplex operation of a given interface when autonegotiation is disabled	IC	4-188
negotiation	Enables autonegotiation of a given interface	IC	4-189
capabilities	Advertises the capabilities of a given interface for use in autonegotiation	IC	4-190
flowcontrol	Enables flow control on a given interface	IC	4-191
media-type	Forces port type selected for combination ports	IC	4-192
giga-phy-mode	Forces two connected ports in to a master/slave configuration to enable 1000BASE-T full duplex	IC	4-193
shutdown	Disables an interface	IC	4-194
switchport packet-rate	Configures the broadcast storm control threshold	IC	4-194
clear counters	Clears statistics on an interface	PE	4-195
show interfaces status	Displays status for the specified interface	NE, PE	4-196
show interfaces counters	Displays statistics for the specified interfaces	NE, PE	4-198
show interfaces switchport	Displays the administrative and operational status of an interface	NE, PE	4-199

### interface

This command configures an interface type and enters interface configuration mode. Use the **no** form to remove a trunk.

### Syntax

**interface** *interface*

**no interface** *port-channel channel-id*

*interface*

- **ethernet** *unit/port*
  - *unit* - Stack unit. (Range: 1)
  - *port* - Port number. (Range: 1-28)
- **port-channel** *channel-id* (Range: 1-8)
- **vlan** *vlan-id* (Range: 1-4094)

## 4 Command Line Interface

### Default Setting

None

### Command Mode

Global Configuration

### Example

To specify port 24, enter the following command:

```
Console(config)#interface ethernet 1/24
Console(config-if)#
```

### description

This command adds a description to an interface. Use the **no** form to remove the description.

### Syntax

**description** *string*

**no description**

*string* - Comment or a description to help you remember what is attached to this interface. (Range: 1-64 characters)

### Default Setting

None

### Command Mode

Interface Configuration (Ethernet, Port Channel)

### Example

The following example adds a description to port 24.

```
Console(config)#interface ethernet 1/24
Console(config-if)#description RD-SW#3
Console(config-if)#
```

### speed-duplex

This command configures the speed and duplex mode of a given interface when autonegotiation is disabled. Use the **no** form to restore the default.

### Syntax

**speed-duplex** {**1000full** | **100full** | **100half** | **10full** | **10half**}

**no speed-duplex**

- **1000full** - Forces 1000 Mbps full-duplex operation
- **100full** - Forces 100 Mbps full-duplex operation
- **100half** - Forces 100 Mbps half-duplex operation
- **10full** - Forces 10 Mbps full-duplex operation
- **10half** - Forces 10 Mbps half-duplex operation

## Default Setting

- Auto-negotiation is enabled by default.
- When auto-negotiation is disabled, the default speed-duplex setting for both 100BASE-TX and Gigabit Ethernet ports is 100full.

## Command Mode

Interface Configuration (Ethernet, Port Channel)

## Command Usage

- The 1000BASE-T standard does not support forced mode. Auto-negotiation should always be used to establish a connection over any 1000BASE-T port or trunk. If not used, the success of the link process cannot be guaranteed when connecting to other types of switches. However, this switch does provide a means of safely forcing a link to operate at 1000 Mbps, full-duplex using the **giga-phy-mode** command (page 4-193).
- To force operation to the speed and duplex mode specified in a **speed-duplex** command, use the **no negotiation** command to disable auto-negotiation on the selected interface.
- When using the **negotiation** command to enable auto-negotiation, the optimal settings will be determined by the **capabilities** command. To set the speed/duplex mode under auto-negotiation, the required mode must be specified in the capabilities list for an interface.

## Example

The following example configures port 5 to 100 Mbps, half-duplex operation.

```
Console(config)#interface ethernet 1/5
Console(config-if)#speed-duplex 100half
Console(config-if)#no negotiation
Console(config-if)#
```

## Related Commands

negotiation (4-189)  
capabilities (4-190)

## negotiation

This command enables autonegotiation for a given interface. Use the **no** form to disable autonegotiation.

## Syntax

[no] negotiation

## Default Setting

Enabled

## Command Mode

Interface Configuration (Ethernet, Port Channel)

## Command Usage

- When auto-negotiation is enabled the switch will negotiate the best settings for a link based on the **capabilities** command. When auto-negotiation is disabled, you must manually specify the link attributes with the **speed-duplex** and **flowcontrol** commands.
- If autonegotiation is disabled, auto-MDI/MDI-X pin signal configuration will also be disabled for the RJ-45 ports.

## Example

The following example configures port 11 to use autonegotiation.

```
Console(config)#interface ethernet 1/11
Console(config-if)#negotiation
Console(config-if)#
```

## Related Commands

- capabilities (4-190)
- speed-duplex (4-188)

## capabilities

This command advertises the port capabilities of a given interface during autonegotiation. Use the **no** form with parameters to remove an advertised capability, or the **no** form without parameters to restore the default values.

## Syntax

**[no] capabilities {1000full | 100full | 100half | 10full | 10half | flowcontrol | symmetric}**

- **1000full** - Supports 1000 Mbps full-duplex operation
- **100full** - Supports 100 Mbps full-duplex operation
- **100half** - Supports 100 Mbps half-duplex operation
- **10full** - Supports 10 Mbps full-duplex operation
- **10half** - Supports 10 Mbps half-duplex operation
- **flowcontrol** - Supports flow control
- **symmetric** (Gigabit only) - When specified, the port transmits and receives pause frames; when not specified, the port will auto-negotiate to determine the sender and receiver for asymmetric pause frames. (*The current switch ASIC only supports symmetric pause frames.*)

## Default Setting

- 100BASE-TX: 10half, 10full, 100half, 100full
- 1000BASE-T: 10half, 10full, 100half, 100full, 1000full
- SFP: 1000full

## Command Mode

Interface Configuration (Ethernet, Port Channel)



## Command Usage

When auto-negotiation is enabled with the **negotiation** command, the switch will negotiate the best settings for a link based on the **capabilities** command. When auto-negotiation is disabled, you must manually specify the link attributes with the **speed-duplex** and **flowcontrol** commands.

## Example

The following example configures Ethernet port 5 capabilities to 100half, 100full and flow control.

```
Console(config)#interface ethernet 1/5
Console(config-if)#capabilities 100half
Console(config-if)#capabilities 100full
Console(config-if)#capabilities flowcontrol
Console(config-if)#
```

## Related Commands

negotiation (4-189)  
speed-duplex (4-188)  
flowcontrol (4-191)

## flowcontrol

This command enables flow control. Use the **no** form to disable flow control.

## Syntax

[no] **flowcontrol**

## Default Setting

Disabled

## Command Mode

Interface Configuration (Ethernet, Port Channel)

## Command Usage

- Flow control can eliminate frame loss by “blocking” traffic from end stations or segments connected directly to the switch when its buffers fill. When enabled, back pressure is used for half-duplex operation and IEEE 802.3x for full-duplex operation.
- To force flow control on or off (with the **flowcontrol** or **no flowcontrol** command), use the **no negotiation** command to disable auto-negotiation on the selected interface.
- When using the **negotiation** command to enable auto-negotiation, the optimal settings will be determined by the **capabilities** command. To enable flow control under auto-negotiation, “flowcontrol” must be included in the capabilities list for any port

## 4 Command Line Interface

- Avoid using flow control on a port connected to a hub unless it is actually required to solve a problem. Otherwise back pressure jamming signals may degrade overall performance for the segment attached to the hub.

### Example

The following example enables flow control on port 5.

```
Console(config)#interface ethernet 1/5
Console(config-if)#flowcontrol
Console(config-if)#no negotiation
Console(config-if)#
```

### Related Commands

- negotiation (4-189)
- capabilities (flowcontrol, symmetric) (4-190)

### media-type

This command forces the port type selected for combination ports 25-28 on iES4028F and 27-28 on iES4028FP. Use the **no** form to restore the default mode.

### Syntax

**media-type** *mode*  
**no media-type**

*mode*

- **copper-forced** - Always uses the built-in RJ-45 port.
- **sfp-forced** - Always uses the SFP port (even if module not installed).
- **sfp-preferred-auto** - Uses SFP port if both combination types are functioning and the SFP port has a valid link.

### Default Setting

sfp-preferred-auto

### Command Mode

Interface Configuration  
(Ethernet - Ports 25-28 on iES4028F, 27-28 on iES4028FP)

### Example

This forces the switch to use the built-in RJ-45 port for the combination port 28.

```
Console(config)#interface ethernet 1/28
Console(config-if)#media-type copper-forced
Console(config-if)#
```

## **giga-phy-mode**

This command forces two connected ports in to a master/slave configuration to enable 1000BASE-T full duplex for Gigabit ports 25-28. Use the **no** form to restore the default mode.

### **Syntax**

```
giga-phy-mode mode  
no giga-phy-mode
```

*mode*

- **master** - Sets the selected port as master.
- **slave** - Sets the selected port as slave.
- **auto-prefer-master** - Uses master mode as the initial configuration setting regardless of the mode configured at the other end of the link.
- **auto-prefer-slave** - Uses slave mode as the initial configuration regardless of the mode configured at the other end of the link.

### **Default Setting**

master

### **Command Mode**

Interface Configuration (Ethernet - Ports 25-28)

### **Command Usage**

- The 1000BASE-T standard does not support forced mode. Auto-negotiation should always be used to establish a connection over any 1000BASE-T port or trunk. If not used, the success of the link process cannot be guaranteed when connecting to other types of switches. However, this switch does provide a means of forcing a link to operate at 1000 Mbps, full-duplex using the **giga-phy-mode** command.
- To force 1000full operation requires the ports at both ends of a link to establish their role in the connection process as a master or slave. Before using this feature, auto-negotiation must first be disabled, and the Speed/Duplex attribute set to 1000full. Then select compatible Giga PHY modes at both ends of the link. Note that using one of the preferred modes ensures that the ports at both ends of a link will eventually cooperate to establish a valid master-slave relationship.

### **Example**

This forces the switch port to master mode on port 28.

```
Console(config)#interface ethernet 1/28  
Console(config-if)#no negotiation  
Console(config-if)#speed-duplex 1000full  
Console(config-if)#giga-phy-mode master  
Console(config-if)#
```

### shutdown

This command disables an interface. To restart a disabled interface, use the **no** form.

### Syntax

**[no] shutdown**

### Default Setting

All interfaces are enabled.

### Command Mode

Interface Configuration (Ethernet, Port Channel)

### Command Usage

This command allows you to disable a port due to abnormal behavior (e.g., excessive collisions), and then reenables it after the problem has been resolved. You may also want to disable a port for security reasons.

### Example

The following example disables port 5.

```
Console(config)#interface ethernet 1/5
Console(config-if)#shutdown
Console(config-if)#
```

### switchport packet-rate

This command configures broadcast and multicast and unknown unicast storm control. Use the **no** form to restore the default setting.

### Syntax

**switchport {broadcast | multicast | unknown-unicast} packet-rate *rate***  
**no switchport {broadcast | multicast | unknown-unicast}**

- **broadcast** - Specifies storm control for broadcast traffic.
- **multicast** - Specifies storm control for multicast traffic.
- **unknown-unicast** - Specifies storm control for unknown unicast traffic.
- **rate** - Threshold level as a rate; i.e., kilobits per second.  
(Range: 64-100000 for 100 Mbps ports, 64-1000000 for 1 Gbps ports)

### Default Setting

Broadcast Storm Control: Enabled, packet-rate limit: 64 kbps

Multicast Storm Control: Disabled

Unknown Unicast Storm Control: Disabled

### Command Mode

Interface Configuration (Ethernet)

## Command Usage

When traffic exceeds the threshold specified for broadcast and multicast or unknown unicast traffic, packets exceeding the threshold are dropped until the rate falls back down beneath the threshold.

## Example

The following shows how to configure broadcast storm control at 500 kilobits per second:

```
Console(config)#interface ethernet 1/5
Console(config-if)#switchport broadcast packet-rate 500
Console(config-if)#
```

## clear counters

This command clears statistics on an interface.

### Syntax

**clear counters** *interface*

*interface*

- **ethernet** *unit/port*
  - *unit* - Stack unit. (Range: 1)
  - *port* - Port number. (Range: 1-28)
- **port-channel** *channel-id* (Range: 1-8)

### Default Setting

None

### Command Mode

Privileged Exec

### Command Usage

Statistics are only initialized for a power reset. This command sets the base value for displayed statistics to zero for the current management session. However, if you log out and back into the management interface, the statistics displayed will show the absolute value accumulated since the last power reset.

## Example

The following example clears statistics on port 5.

```
Console#clear counters ethernet 1/5
Console#
```

### show interfaces status

This command displays the status for an interface.

#### Syntax

**show interfaces status** [*interface*]

*interface*

- **ethernet** *unit/port*
  - *unit* - Stack unit. (Range: 1)
  - *port* - Port number. (Range: 1-28)
- **port-channel** *channel-id* (Range: 1-8)
- **vlan** *vlan-id* (Range: 1-4094)

#### Default Setting

Shows the status for all interfaces.

#### Command Mode

Normal Exec, Privileged Exec

#### Command Usage

If no interface is specified, information on all interfaces is displayed. For a description of the items displayed by this command, see "Displaying Connection Status" on page 3-127.

**Example**

```
Console#show interfaces status ethernet 1/5
Information of Eth 1/5
Basic information:
  Port type:                100TX
  Mac address:              00-12-CF-12-34-61
Configuration:
  Name:
  Port admin:              Up
  Speed-duplex:            Auto
  Capabilities:            10half, 10full, 100half, 100full,
  Broadcast storm:        Enabled
  Broadcast storm limit:   64 Kbits/second
  Multicast Storm:        Disabled
  Multicast Storm Limit:  64 Kbits/second
  UnknownUnicast Storm:   Disabled
  UnknownUnicast Storm Limit: 64 Kbits/second
  Flow control:            Disabled
  LACP:                    Disabled
  Port Security:          Disabled
  Max MAC count:          0
  Port Security Action:   None
  Media Type:             None
  Giga PHY mode: Auto preferred master
Current status:
  Link status:             Up
  Port operation status:   Up
  Operation speed-duplex: 100full
  Flow control type:      None
Console#show interfaces status vlan 1
Information of VLAN 1
  MAC address:            00-12-CF-12-34-56
Console#
```

### show interfaces counters

This command displays interface statistics.

#### Syntax

```
show interfaces counters [interface]
```

*interface*

- **ethernet** *unit/port*
  - *unit* - Stack unit. (Range: 1)
  - *port* - Port number. (Range: 1-28)
- **port-channel** *channel-id* (Range: 1-8)

#### Default Setting

Shows the counters for all interfaces.

#### Command Mode

Normal Exec, Privileged Exec

#### Command Usage

If no interface is specified, information on all interfaces is displayed. For a description of the items displayed by this command, see “Showing Port Statistics” on page 3-149.

#### Example

```
Console#show interfaces counters ethernet 1/7
Ethernet 1/7
Iftable stats:
Octets input: 30658, Octets output: 196550
Unicast input: 6, Unicast output: 5
Discard input: 0, Discard output: 0
Error input: 0, Error output: 0
Unknown protos input: 0, QLen output: 0
Extended iftable stats:
Multi-cast input: 0, Multi-cast output: 3064
Broadcast input: 262, Broadcast output: 1
Ether-like stats:
Alignment errors: 0, FCS errors: 0
Single Collision frames: 0, Multiple collision frames: 0
SQE Test errors: 0, Deferred transmissions: 0
Late collisions: 0, Excessive collisions: 0
Internal mac transmit errors: 0, Internal mac receive errors: 0
Frame too longs: 0, Carrier sense errors: 0
Symbol errors: 0
RMON stats:
Drop events: 0, Octets: 227208, Packets: 3338
Broadcast pkts: 263, Multi-cast pkts: 3064
Undersize pkts: 0, Oversize pkts: 0
Fragments: 0, Jabbers: 0
CRC align errors: 0, Collisions: 0
Packet size <= 64 octets: 3150, Packet size 65 to 127 octets: 139
Packet size 128 to 255 octets: 49, Packet size 256 to 511 octets: 0
Packet size 512 to 1023 octets: 0, Packet size 1024 to 1518 octets: 0
Console#
```



## show interfaces switchport

This command displays the administrative and operational status of the specified interfaces.

### Syntax

**show interfaces switchport** [*interface*]

*interface*

- **ethernet** *unit/port*
  - *unit* - Stack unit. (Range: 1)
  - *port* - Port number. (Range: 1-28)
- **port-channel** *channel-id* (Range: 1-8)

### Default Setting

Shows all interfaces.

### Command Mode

Normal Exec, Privileged Exec

### Command Usage

If no interface is specified, information on all interfaces is displayed.

### Example

This example shows the configuration setting for port 24.

```

Console#show interfaces switchport ethernet 1/24
Broadcast Threshold:      Enabled, 64 Kbits/second
Multicast Threshold:     Disabled
Unknown-unicast Threshold: Disabled
LACP Status:             Disabled
Ingress Rate Limit:      Disabled, 100000 Kbits per second
Egress Rate Limit:       Disabled, 100000 Kbits per second
VLAN Membership Mode:    Hybrid
Ingress Rule:            Enabled
Acceptable Frame Type:   All frames
Native VLAN:             1
Priority for Untagged Traffic: 0
GVRP Status:             Disabled
Allowed VLAN:            1(u),4093(t),
Forbidden VLAN:
Private-VLAN Mode:       NONE
Private-VLAN host-association: NONE
Private-VLAN Mapping:    NONE
802.1Q-tunnel Status:    Disable
802.1Q-tunnel Mode:      NORMAL
802.1Q-tunnel TPID:      8100(Hex)
Console#

```

**Table 4-52 Interfaces Switchport Statistics**

Field	Description
Broadcast Threshold	Shows if broadcast storm suppression is enabled or disabled; if enabled it also shows the threshold level (page 4-194).
Multicast Threshold	Shows if multicast storm suppression is enabled or disabled; if enabled it also shows the threshold level (page 4-194).
Unknown-unicast Threshold	Shows if unknown unicast storm suppression is enabled or disabled; if enabled it also shows the threshold level (page 4-194).
LACP Status	Shows if Link Aggregation Control Protocol has been enabled or disabled (page 4-203).
Ingress Rate Limit	Shows if ingress rate limiting is enabled, and the current rate limit. (page 4-220).
Egress Rate Limit	Shows if egress rate limiting is enabled, and the current rate limit. (page 4-220).
VLAN Membership Mode	Indicates membership mode as Trunk or Hybrid (page 4-255).
Ingress Rule	Shows if ingress filtering is enabled or disabled (page 4-256). <b>Note:</b> Ingress filtering is always enabled.
Acceptable Frame Type	Shows if acceptable VLAN frames include all types or tagged frames only (page 4-255).
Native VLAN	Indicates the default Port VLAN ID (page 4-257).
Priority for Untagged Traffic	Indicates the default priority for untagged frames (page 4-284).
GVRP Status	Shows if GARP VLAN Registration Protocol is enabled or disabled (page 4-249).
Allowed VLAN	Shows the VLANs this interface has joined, where "(u)" indicates untagged and "(t)" indicates tagged (page 4-258).
Forbidden VLAN	Shows the VLANs this interface can not dynamically join via GVRP (page 4-259).
Private-VLAN Mode	Shows the private VLAN mode as host, promiscuous, or none (4-271).
Private VLAN host-association	Shows the secondary (or community) VLAN with which this port is associated (4-272).
Private VLAN mapping	Shows the primary VLAN mapping for a promiscuous port (4-273).
802.1Q-tunnel Status	Shows if 802.1Q tunnel is enabled on this interface (page 4-262).
802.1Q-tunnel Mode	Shows the tunnel mode as Normal, 802.1Q Tunnel or 802.1Q Tunnel Uplink (page 4-262).
802.1Q-tunnel TPID	Shows the Tag Protocol Identifier used for learning and switching packets (page 4-263).

## Link Aggregation Commands

Ports can be statically grouped into an aggregate link (i.e., trunk) to increase the bandwidth of a network connection or to ensure fault recovery. Or you can use the Link Aggregation Control Protocol (LACP) to automatically negotiate a trunk link between this switch and another network device. For static trunks, the switches have to comply with the Cisco EtherChannel standard. For dynamic trunks, the switches have to comply with LACP. This switch supports up to eight trunks. For example, a trunk consisting of two 1000 Mbps ports can support an aggregate bandwidth of 4 Gbps when operating at full duplex.

**Table 4-53 Link Aggregation Commands**

Command	Function	Mode	Page
<i>Manual Configuration Commands</i>			
interface port-channel	Configures a trunk and enters interface configuration mode for the trunk	GC	4-187
channel-group	Adds a port to a trunk	IC (Ethernet)	4-202
<i>Dynamic Configuration Command</i>			
lACP	Configures LACP for the current interface	IC (Ethernet)	4-203
lACP system-priority	Configures a port's LACP system priority	IC (Ethernet)	4-204
lACP admin-key	Configures a port's administration key	IC (Ethernet)	4-205
lACP admin-key	Configures an port channel's administration key	IC (Port Channel)	4-206
lACP port-priority	Configures a port's LACP port priority	IC (Ethernet)	4-207
lACP active/passive	Configures active or passive LACP initiation mode	IC (Ethernet)	4-208
<i>Trunk Status Display Command</i>			
show interfaces status port-channel	Shows trunk information	NE, PE	4-196
show lACP	Shows LACP information	PE	4-208

### Guidelines for Creating Trunks

#### *General Guidelines –*

- Finish configuring port trunks before you connect the corresponding network cables between switches to avoid creating a loop.
- A trunk can have up to eight ports.
- The ports at both ends of a connection must be configured as trunk ports.
- All ports in a trunk must be configured in an identical manner, including communication mode (i.e., speed, duplex mode and flow control), VLAN assignments, and CoS settings.
- Any of the SFP transceivers can be trunked together, including those of different media types.
- All the ports in a trunk have to be treated as a whole when moved from/to, added or deleted from a VLAN via the specified port-channel.

## 4 Command Line Interface

- STP, VLAN, and IGMP settings can only be made for the entire trunk via the specified port-channel.

### *Dynamically Creating a Port Channel –*

Ports assigned to a common port channel must meet the following criteria:

- Ports must have the same LACP system priority.
- Ports must have the same port admin key (Ethernet Interface).
- If the port channel admin key (lacp admin key - Port Channel) is not set when a channel group is formed (i.e., it has the null value of 0), this key is set to the same value as the port admin key (lacp admin key - Ethernet Interface) used by the interfaces that joined the group.
- However, if the port channel admin key is set, then the port admin key must be set to the same value for a port to be allowed to join a channel group.
- If a link goes down, LACP port priority is used to select the backup link.

### **channel-group**

This command adds a port to a trunk. Use the **no** form to remove a port from a trunk.

#### **Syntax**

**channel-group** *channel-id*

**no channel-group**

*channel-id* - Trunk index (Range: 1-8)

#### **Default Setting**

The current port will be added to this trunk.

#### **Command Mode**

Interface Configuration (Ethernet)

#### **Command Usage**

- When configuring static trunks, the switches must comply with the Cisco EtherChannel standard.
- Use **no channel-group** to remove a port group from a trunk.
- Use **no interfaces port-channel** to remove a trunk from the switch.

#### **Example**

The following example creates trunk 1 and then adds port 11:

```
Console(config)#interface port-channel 1
Console(config-if)#exit
Console(config)#interface ethernet 1/11
Console(config-if)#channel-group 1
Console(config-if)#
```

**lacp**

This command enables 802.3ad Link Aggregation Control Protocol (LACP) for the current interface. Use the **no** form to disable it.

**Syntax**

[no] lacp

**Default Setting**

Disabled

**Command Mode**

Interface Configuration (Ethernet)

**Command Usage**

- The ports on both ends of an LACP trunk must be configured for full duplex, and auto-negotiation.
- A trunk formed with another switch using LACP will automatically be assigned the next available port-channel ID.
- If the target switch has also enabled LACP on the connected ports, the trunk will be activated automatically.
- If more than eight ports attached to the same target switch have LACP enabled, the additional ports will be placed in standby mode, and will only be enabled if one of the active links fails.

### Example

The following shows LACP enabled on ports 11-13. Because LACP has also been enabled on the ports at the other end of the links, the **show interfaces status port-channel 1** command shows that Trunk 1 has been established.

```
Console(config)#interface ethernet 1/11
Console(config-if)#lACP
Console(config-if)#exit
Console(config)#interface ethernet 1/12
Console(config-if)#lACP
Console(config-if)#exit
Console(config)#interface ethernet 1/13
Console(config-if)#lACP
Console(config-if)#exit
Console(config)#exit
Console#show interfaces status port-channel 1
Information of Trunk 1
Basic information:
  Port type:          100TX
  Mac address:       00-12-CF-12-34-72
Configuration:
  Name:
  Port admin:       Up
  Speed-duplex:     Auto
  Capabilities:     10half, 10full, 100half, 100full
  Flow control status: Disabled
  Port security:    Disabled
  Max MAC count:    0
  Giga PHY mode:    Auto preferred master
Current status:
  Created by:       LACP
  Link status:      Up
  Port Operation Status: Up
  Operation speed-duplex: 100full
  Flow control type: None
  Member Ports:    Eth1/11, Eth1/12, Eth1/13,
Console#
```

### lACP system-priority

This command configures a port's LACP system priority. Use the **no** form to restore the default setting.

### Syntax

```
lACP {actor | partner} system-priority priority
no lACP {actor | partner} system-priority
```

- **actor** - The local side an aggregate link.
- **partner** - The remote side of an aggregate link.
- **priority** - This priority is used to determine link aggregation group (LAG) membership, and to identify this device to other switches during LAG negotiations. (Range: 0-65535)

### Default Setting

32768

## Command Mode

Interface Configuration (Ethernet)

## Command Usage

- Port must be configured with the same system priority to join the same LAG.
- System priority is combined with the switch's MAC address to form the LAG identifier. This identifier is used to indicate a specific LAG during LACP negotiations with other systems.
- Once the remote side of a link has been established, LACP operational settings are already in use on that side. Configuring LACP settings for the partner only applies to its administrative state, not its operational state, and will only take effect the next time an aggregate link is established with the partner.

## Example

```
Console(config)#interface ethernet 1/5
Console(config-if)#lacp actor system-priority 3
Console(config-if)#
```

## lacp admin-key (Ethernet Interface)

This command configures a port's LACP administration key. Use the **no** form to restore the default setting.

## Syntax

```
lacp {actor | partner} admin-key key
[no] lacp {actor | partner} admin-key
```

- **actor** - The local side an aggregate link.
- **partner** - The remote side of an aggregate link.
- **key** - The port admin key must be set to the same value for ports that belong to the same link aggregation group (LAG). (Range: 0-65535)

## Default Setting

0

## Command Mode

Interface Configuration (Ethernet)

## Command Usage

- Ports are only allowed to join the same LAG if (1) the LACP system priority matches, (2) the LACP port admin key matches, and (3) the LACP port channel key matches (if configured).
- If the port channel admin key (**lacp admin key** - Port Channel) is not set when a channel group is formed (i.e., it has the null value of 0), this key is set to the same value as the port admin key (**lacp admin key** - Ethernet Interface) used by the interfaces that joined the group.

## 4 Command Line Interface

- Once the remote side of a link has been established, LACP operational settings are already in use on that side. Configuring LACP settings for the partner only applies to its administrative state, not its operational state, and will only take effect the next time an aggregate link is established with the partner.

### Example

```
Console(config)#interface ethernet 1/5
Console(config-if)#lACP actor admin-key 120
Console(config-if)#
```

### lACP admin-key (Port Channel)

This command configures a port channel's LACP administration key string. Use the **no** form to restore the default setting.

### Syntax

```
lACP {actor | partner} admin-key key
[no] lACP {actor | partner} admin-key
```

*key* - The port channel admin key is used to identify a specific link aggregation group (LAG) during local LACP setup on this switch. (Range: 0-65535)

### Default Setting

0

### Command Mode

Interface Configuration (Port Channel)

### Command Usage

- Ports are only allowed to join the same LAG if (1) the LACP system priority matches, (2) the LACP port admin key matches, and (3) the LACP port channel key matches (if configured).
- If the port channel admin key (**lACP admin key** - Port Channel) is not set when a channel group is formed (i.e., it has the null value of 0), this key is set to the same value as the port admin key (**lACP admin key** - Ethernet Interface) used by the interfaces that joined the group. Note that when the LAG is no longer used, the port channel admin key is reset to 0.

### Example

```
Console(config)#interface port-channel 1
Console(config-if)#lACP actor admin-key 3
Console(config-if)#
```



## lACP port-priority

This command configures LACP port priority. Use the **no** form to restore the default setting.

### Syntax

```
lACP {actor | partner} port-priority priority  
no lACP {actor | partner} port-priority
```

- **actor** - The local side an aggregate link.
- **partner** - The remote side of an aggregate link.
- *priority* - LACP port priority is used to select a backup link. (Range: 0-65535)

### Default Setting

32768

### Command Mode

Interface Configuration (Ethernet)

### Command Usage

- Setting a lower value indicates a higher effective priority.
- If an active port link goes down, the backup port with the highest priority is selected to replace the downed link. However, if two or more ports have the same LACP port priority, the port with the lowest physical port number will be selected as the backup port.
- Once the remote side of a link has been established, LACP operational settings are already in use on that side. Configuring LACP settings for the partner only applies to its administrative state, not its operational state, and will only take effect the next time an aggregate link is established with the partner.

### Example

```
Console(config)#interface ethernet 1/5  
Console(config-if)#lACP actor port-priority 128  
Console(config-if)#
```

### lACP active/passive

This command configures active or passive LACP initiation mode. Use the **no** form to restore the default setting.

#### Syntax

```
lACP {actor | partner} {active | passive}  
no lACP {actor | partner}
```

- **actor** - The local side an aggregate link.
- **partner** - The remote side of an aggregate link.
- **active** - Enables active initiation of LACP negotiation on a port, automatically sending LACP negotiation packets.
- **passive** - Enables passive initiation of LACP negotiation on a port, which starts negotiations only if an LACP device is detected at the other end of the link.

#### Default Setting

active

#### Command Mode

Interface Configuration (Ethernet)

#### Command Usage

Regardless of the LACP initiation mode, if the target switch has also enabled LACP on the connected ports and negotiations are successfully completed, the trunk will be activated automatically.

#### Example

```
Console(config)#interface ethernet 1/5  
Console(config-if)#lACP actor active  
Console(config-if)#
```

### show lACP

This command displays LACP information.

#### Syntax

```
show lACP [port-channel] {counters | internal | neighbors | sysid}
```

- *port-channel* - Local identifier for a link aggregation group. (Range: 1-8)
- **counters** - Statistics for LACP protocol messages.
- **internal** - Configuration settings and operational state for local side.
- **neighbors** - Configuration settings and operational state for remote side.
- **sysid** - Summary of system priority and MAC address for all channel groups.

#### Default Setting

Port Channel: all

**Command Mode**

Privileged Exec

**Example**

```

Console#show lacp 1 counters
Port channel : 1
-----
Eth 1/11
-----
  LACPDU Sent : 21
  LACPDU Received : 21
  Marker Sent : 0
  Marker Received : 0
  LACPDU Unknown Pkts : 0
  LACPDU Illegal Pkts : 0
  :

```

**Table 4-54 show lacp counters - display description**

Field	Description
LACPDU Sent	Number of valid LACPDU transmitted from this channel group.
LACPDU Received	Number of valid LACPDU received on this channel group.
Marker Sent	Number of valid Marker PDUs transmitted from this channel group.
Marker Received	Number of valid Marker PDUs received by this channel group.
LACPDU Unknown Pkts	Number of frames received that either (1) Carry the Slow Protocols Ethernet Type value, but contain an unknown PDU, or (2) are addressed to the Slow Protocols group MAC Address, but do not carry the Slow Protocols Ethernet Type.
LACPDU Illegal Pkts	Number of frames that carry the Slow Protocols Ethernet Type value, but contain a badly formed PDU or an illegal value of Protocol Subtype.

## 4 Command Line Interface

```

Console#show lacp 1 internal
Port Channel : 1
-----
Oper Key : 4
Admin Key : 0
Eth 1/1
-----
LACPDUs Internal:      30 sec
LACP System Priority:  32768
LACP Port Priority:    32768
Admin Key:             3
Oper Key:              3
Admin State: defaulted, aggregation, long timeout, active
Oper State:            distributing, collecting, synchronization,
                       aggregation, long timeout, active
:

```

**Table 4-55 show lacp internal - display description**

Field	Description
Oper Key	Current operational value of the key for the aggregation port.
Admin Key	Current administrative value of the key for the aggregation port.
LACPDUs Internal	Number of seconds before invalidating received LACPDU information.
LACP System Priority	LACP system priority assigned to this port channel.
LACP Port Priority	LACP port priority assigned to this interface within the channel group.
Admin State, Oper State	Administrative or operational values of the actor's state parameters: <ul style="list-style-type: none"> <li>Expired – The actor's receive machine is in the expired state;</li> <li>Defaulted – The actor's receive machine is using defaulted operational partner information, administratively configured for the partner.</li> <li>Distributing – If false, distribution of outgoing frames on this link is disabled; i.e., distribution is currently disabled and is not expected to be enabled in the absence of administrative changes or changes in received protocol information.</li> <li>Collecting – Collection of incoming frames on this link is enabled; i.e., collection is currently enabled and is not expected to be disabled in the absence of administrative changes or changes in received protocol information.</li> <li>Synchronization – The System considers this link to be IN_SYNC; i.e., it has been allocated to the correct Link Aggregation Group, the group has been associated with a compatible Aggregator, and the identity of the Link Aggregation Group is consistent with the System ID and operational Key information transmitted.</li> <li>Aggregation – The system considers this link to be aggregatable; i.e., a potential candidate for aggregation.</li> <li>Long timeout – Periodic transmission of LACPDUs uses a slow transmission rate.</li> <li>LACP-Activity – Activity control value with regard to this link. (0: Passive; 1: Active)</li> </ul>

```

Console#show lacp 1 neighbors
Port channel 1 neighbors
-----
Eth 1/11
-----
Partner Admin System ID: 32768, 00-00-00-00-00-00
Partner Oper System ID: 32768, 00-16-B6-F0-71-3C
Partner Admin Port Number: 11
Partner Oper Port Number: 11
Port Admin Priority: 32768
Port Oper Priority: 32768
Admin Key: 0
Oper Key: 3
Admin State: defaulted, distributing, collecting,
              synchronization, long timeout,
Oper State: distributing, collecting, synchronization,
              aggregation, long timeout, active
:

```

**Table 4-56 show lacp neighbors - display description**

Field	Description
Partner Admin System ID	LAG partner's system ID assigned by the user.
Partner Oper System ID	LAG partner's system ID assigned by the LACP protocol.
Partner Admin Port Number	Current administrative value of the port number for the protocol Partner.
Partner Oper Port Number	Operational port number assigned to this aggregation port by the port's protocol partner.
Port Admin Priority	Current administrative value of the port priority for the protocol partner.
Port Oper Priority	Priority value assigned to this aggregation port by the partner.
Admin Key	Current administrative value of the Key for the protocol partner.
Oper Key	Current operational value of the Key for the protocol partner.
Admin State	Administrative values of the partner's state parameters. (See preceding table.)
Oper State	Operational values of the partner's state parameters. (See preceding table.)

## 4 Command Line Interface

```
Console#show lacp sysid
Port Channel      System Priority      System MAC Address
-----
1                  32768                00-13-F7-D3-7E-60
2                  32768                00-13-F7-D3-7E-60
3                  32768                00-13-F7-D3-7E-60
4                  32768                00-13-F7-D3-7E-60
5                  32768                00-13-F7-D3-7E-60
6                  32768                00-13-F7-D3-7E-60
7                  32768                00-13-F7-D3-7E-60
8                  32768                00-13-F7-D3-7E-60
Console#
```

**Table 4-57 show lacp sysid - display description**

Field	Description
Channel group	A link aggregation group configured on this switch.
System Priority*	LACP system priority for this channel group.
System MAC Address*	System MAC address.

\* The LACP system priority and system MAC address are concatenated to form the LAG system ID.

## Power over Ethernet Commands

The commands in this group control the power that can be delivered to attached PoE devices through the switch ports.

The switch's power management enables total switch power and individual port power to be controlled within a configured power budget. Port power can be automatically turned on and off for connected devices, and a per-port power priority can be set so that the switch never exceeds its allocated power budget. When a device is connected to a switch port, its power requirements are detected by the switch before power is supplied. If the power required by a device exceeds the power budget of the port or the whole switch, power is not supplied.

**Table 4-58 PoE Commands**

Command Group	Function	Mode	Page
power mainpower maximum allocation	Sets the maximum power available to all switch ports	GC	4-213
power inline compatible	Provides power to pre-standard PoE devices	GC	4-213
power inline	Turns power on and off for specific ports	IC	4-214
power inline maximum allocation	Sets the maximum power available to specific switch ports	IC	4-215
power inline priority	Sets the priority for power supplied to specific ports	IC	4-215
show power inline status	Displays the current status of power management on specific ports or all ports	PE	4-216
show power mainpower	Displays the current status of power management for switch	PE	4-217

### **power mainpower maximum allocation**

This command defines a power budget for the switch (i.e., the power available to all switch ports). Use the **no** form to restore the default setting.

#### **Syntax**

**power mainpower maximum allocation *watts***

*watts* - The power budget for the switch. (Range: 37-180 watts)

#### **Default Setting**

180 watts

#### **Command Mode**

Global Configuration

#### **Command Usage**

- Setting a maximum power budget for the switch enables power to be centrally managed, preventing overload conditions at the power source.
- If the power demand from devices connected to the switch exceeds the power budget setting, the switch uses port power priority settings to limit the supplied power.

#### **Example**

```
Console(config)#power mainpower maximum allocation 180
Console(config)#
```

#### **Related Commands**

power inline priority (4-215)

### **power inline compatible**

This command allows the switch to detect and provide power to powered devices that were designed prior to the IEEE 802.3af PoE standard. Use the **no** form to disable this feature.

#### **Syntax**

**[no] power inline compatible**

#### **Default Setting**

Disabled

#### **Command Mode**

Global Configuration

#### **Command Usage**

- The switch automatically detects attached PoE devices by periodically transmitting test voltages that over the 10/100BASE-TX ports. When an 802.3af compatible device is plugged into one of these ports, the powered device reflects the test voltage back to the switch, which may then turn on the power to this device. When the **power inline compatible** command is used,

## 4 Command Line Interface

this switch can detect 802.3af compliant devices and the more recent 802.3af non-compliant devices that also reflect the test voltages back to the switch. It cannot detect other legacy devices that do not reflect back the test voltages.

- For legacy devices to be supported by this switch, they must be able to accept power over the data pairs connected to the 10/100BASE-TX ports.

### Example

```
Console(config)#power inline compatible
Console(config)#end
Console#show power inline status
Unit: 1
Compatible mode : Enabled
Interface Admin Oper Power(mWatt) Power(used) Priority
-----
Eth 1/ 1 enable off 15400 0 low
Eth 1/ 2 enable off 15400 0 low
Eth 1/ 3 enable off 15400 0 low
Eth 1/ 4 enable off 15400 0 low
Eth 1/ 5 enable off 15400 0 low
:
```

### power inline

This command instructs the switch to automatically detect if a PoE-compliant device is connected to the specified port, and turn power on or off accordingly. Use the **no** form to turn off power for a port.

### Syntax

[no] power inline

### Default Setting

Detection is enabled for PoE-compliant devices.

### Command Mode

Interface Configuration

### Command Usage

When detection is enabled for PoE-compliant devices, power is automatically supplied when a device is detected on the port, providing that the power demanded does not exceed switch's power budget.

### Example

```
Console(config)#interface ethernet 1/1
Console(config-if)#power inline auto
Console(config-if)#exit
Console(config)#interface ethernet 1/2
Console(config-if)#no power inline
Console(config-if)#
```



### power inline maximum allocation

This command limits the power allocated to specific ports. Use the **no** form to restore the default setting.

#### Syntax

**power inline maximum allocation** *milliwatts*  
**no power inline maximum allocation**

*milliwatts* - The maximum power budget for the port.  
(Range: 3000 - 15400 milliwatts).

#### Default Setting

15400 milliwatts

#### Command Mode

Interface Configuration

#### Command Usage

If a device is connected to a switch port and the switch detects that it requires more than the maximum power allocated to the port, no power is supplied to the device (i.e., port power remains off).

#### Example

```
Console(config)#interface ethernet 1/1
Console(config-if)#power inline maximum allocation 8000
Console(config-if)#
```

### power inline priority

This command sets the power priority for specific ports. Use the **no** form to restore the default setting.

#### Syntax

**power inline priority** *priority*  
**no power inline priority**

*priority* - The power priority for the port.  
Options: 1 (critical), 2 (high), or 3 (low)

#### Default Setting

3 (low)

#### Command Mode

Interface Configuration

#### Command Usage

- If the power demand from devices connected to the switch exceeds the power budget setting, the switch uses port power priority settings to control the supplied power. For example:
  - A device connected to a low-priority port that causes the switch to exceed its budget is not supplied power.

## 4 Command Line Interface

- A device connected to a critical or high-priority port that causes the switch to exceed its budget is supplied power, but the switch drops power to one or more lower-priority ports.
- Power is dropped from low-priority ports in sequence starting from port number 1.

### Example

```
Console(config)#interface ethernet 1/1
Console(config-if)#power inline priority 2
Console(config-if)#
```

### Related Commands

power mainpower maximum allocation (4-213)

### show power inline status

This command displays the current power status for all ports or for specific ports.

### Syntax

**show power inline status** [*interface*]

*interface*

**ethernet**

- *unit* - Stack unit. (Range: 1-8)
- *port* - Port number. (Range: 1-26)

### Command Mode

Privileged Exec

### Example

```
Console#show power inline status
Interface Admin Oper Power(mWatt) Power(used) Priority
-----
Eth 1/ 1 enable off 15400 0 low
Eth 1/ 2 enable off 15400 0 low
Eth 1/ 3 enable on 15400 7505 low
Eth 1/ 4 enable off 15400 0 low
Eth 1/ 5 enable off 15400 0 low
Eth 1/ 6 enable off 15400 0 low
Eth 1/ 7 enable on 15400 8597 low
:
```

**Table 4-59 show power inline status parameters**

Parameter	Description
Admin	The power mode set on the port (see <b>power inline</b> on page -214)
Oper	The current operating power status (displays on or off)
Power (mWatt)	The maximum power allocated to this port (see <b>power inline maximum allocation</b> on page -215)

Table 4-59 show power inline status parameters (Continued)

Parameter	Description
Power (used)	The current power consumption on the port in milliwatts
Priority	The port's power priority setting (see <b>power inline priority</b> on page -215)

### show power mainpower

Use this command to display the current power status for the switch.

#### Command Mode

Privileged Exec

#### Example

```

Console#show power mainpower
Unit 1 Mainpower Status
  Maximum Available Power : 180 watts
  System Operation Status : on
  Mainpower Consumption   : 15 watts
  Software Version        : Version 0x01F9, Build 0x04
Console#

```

Table 4-60 show power mainpower parameters

Parameter	Description
Maximum Available Power	The available power budget for the switch (see <b>power mainpower maximum allocation</b> on page -213)
System Operation Status	The current operating power status (displays on or off)
Mainpower Consumption	The current power consumption on the switch in watts
Software Version	The version of software running on the PoE controller subsystem in the switch.

## Mirror Port Commands

This section describes how to mirror traffic from a source port to a target port.

Table 4-61 Mirror Port Commands

Command	Function	Mode	Page
port monitor	Configures a mirror session	IC	4-218
show port monitor	Shows the configuration for a mirror port	PE	4-219

### port monitor

This command configures a mirror session. Use the **no** form to clear a mirror session.

### Syntax

**port monitor** *interface* [**rx** | **tx** | **both**]

**no port monitor** *interface*

- *interface* - **ethernet unit/port** (source port)
  - *unit* - Stack unit. (Range: 1)
  - *port* - Port number. (Range: 1-28)
- **rx** - Mirror received packets.
- **tx** - Mirror transmitted packets.
- **both** - Mirror both received and transmitted packets.

### Default Setting

No mirror session is defined. When enabled, the default mirroring is for both received and transmitted packets.

### Command Mode

Interface Configuration (Ethernet, destination port)

### Command Usage

- You can mirror traffic from any source port to a destination port for real-time analysis. You can then attach a logic analyzer or RMON probe to the destination port and study the traffic crossing the source port in a completely unobtrusive manner.
- The destination port is set by specifying an Ethernet interface.
- The mirror port and monitor port speeds should match, otherwise traffic may be dropped from the monitor port.
- You can create multiple mirror sessions, but all sessions must share the same destination port. However, you should avoid sending too much traffic to the destination port from multiple source ports.

## Example

The following example configures the switch to mirror received packets from port 6 to 11:

```
Console(config)#interface ethernet 1/11
Console(config-if)#port monitor ethernet 1/6 rx
Console(config-if)#
```

## show port monitor

This command displays mirror information.

## Syntax

**show port monitor** [*interface*]

*interface* - **ethernet** *unit/port* (source port)

- *unit* - Stack unit. (Range: 1)
- *port* - Port number. (Range: 1-28)

## Default Setting

Shows all sessions.

## Command Mode

Privileged Exec

## Command Usage

This command displays the currently configured source port, destination port, and mirror mode (i.e., RX, TX, RX/TX).

## Example

The following shows mirroring configured from port 6 to port 11:

```
Console(config)#interface ethernet 1/11
Console(config-if)#port monitor ethernet 1/6 rx
Console(config-if)#end
Console#show port monitor
Port Mirroring
-----
Destination port(listen port):Eth1/11
Source port(monitored port) :Eth1/6
Mode                        :RX
Console#
```

## Rate Limit Commands

This function allows the network manager to control the maximum rate for traffic received on an interface. Rate limiting is configured on interfaces at the edge of a network to limit traffic into the network. Packets that exceed the acceptable amount of traffic are dropped.

Rate limiting can be applied to individual ports or trunks. When an interface is configured with this feature, the traffic rate will be monitored by the hardware to verify conformity. Non-conforming traffic is dropped.

**Table 4-62 Rate Limit Commands**

Command	Function	Mode	Page
rate-limit	Configures the maximum input rate for a port	IC	4-220

### rate-limit

Use this command to define the rate limit level for a specific interface. Use this command without specifying a rate to restore the default rate limit. Use the **no** form to restore the default status of disabled.

### Syntax

**rate-limit** {**input** | **output**} [*rate*]

**no rate-limit** <**input** | **output**>

- **input** – Input rate limit
- **output** – Input rate limit
- *rate* – The traffic rate limit level. Range: 64-100000 kilobits per second for 100 Mbps ports; 64-1000000 kilobits per second for 1 Gbps ports

### Default Setting

Status: Disabled

Rate Limit: 100000 kilobits per second for 100 Mbps ports; 1000000 kilobits per second for 1 Gbps ports

### Command Mode

Interface Configuration (Ethernet, Port Channel)

### Example

```
Console(config)#interface ethernet 1/1
Console(config-if)#rate-limit input 2000
Console(config-if)#
```

## Address Table Commands

These commands are used to configure the address table for filtering specified addresses, displaying current entries, clearing the table, or setting the aging time.

**Table 4-63 Address Table Commands**

Command	Function	Mode	Page
mac-address-table static	Maps a static address to a port in a VLAN	GC	4-221
clear mac-address-table dynamic	Removes any learned entries from the forwarding database	PE	4-222
show mac-address-table	Displays entries in the bridge-forwarding database	PE	4-223
mac-address-table aging-time	Sets the aging time of the address table	GC	4-224
show mac-address-table aging-time	Shows the aging time for the address table	PE	4-224

### mac-address-table static

This command maps a static address to a destination port in a VLAN. Use the **no** form to remove an address.

### Syntax

**mac-address-table static** *mac-address* **interface** *interface*  
**vlan** *vlan-id* [*action*]

**no mac-address-table static** *mac-address* **vlan** *vlan-id*

- *mac-address* - MAC address.
- *interface*
  - **ethernet** *unit/port*
    - *unit* - Stack unit. (Range: 1)
    - *port* - Port number. (Range: 1-28)
  - **port-channel** *channel-id* (Range: 1-8)
- *vlan-id* - VLAN ID (Range: 1-4094)
- *action* -
  - **delete-on-reset** - Assignment lasts until the switch is reset.
  - **permanent** - Assignment is permanent.

### Default Setting

No static addresses are defined. The default mode is **permanent**.

### Command Mode

Global Configuration

### Command Usage

The static address for a host device can be assigned to a specific port within a specific VLAN. Use this command to add static addresses to the MAC Address Table. Static addresses have the following characteristics:

- Static addresses will not be removed from the address table when a given interface link is down.
- Static addresses are bound to the assigned interface and will not be moved. When a static address is seen on another interface, the address will be ignored and will not be written to the address table.
- A static address cannot be learned on another port until the address is removed with the **no** form of this command.

### Example

```
Console(config)#mac-address-table static 00-12-cf-94-34-de interface
 ethernet 1/1 vlan 1 delete-on-reset
Console(config)#
```

### clear mac-address-table dynamic

This command removes any learned entries from the forwarding database and clears the transmit and receive counts for any static or system configured entries.

### Default Setting

None

### Command Mode

Privileged Exec

### Example

```
Console#clear mac-address-table dynamic
Console#
```



**show mac-address-table**

This command shows classes of entries in the bridge-forwarding database.

**Syntax**

```
show mac-address-table [address mac-address [mask]] [interface interface]
[vlan vlan-id] [sort {address | vlan | interface}]
```

- *mac-address* - MAC address.
- *mask* - Bits to match in the address.
- *interface*
  - **ethernet** *unit/port*
    - *unit* - Stack unit. (Range: 1)
    - *port* - Port number. (Range: 1-28)
  - **port-channel** *channel-id* (Range: 1-8)
- *vlan-id* - VLAN ID (Range: 1-4094)
- **sort** - Sort by address, vlan or interface.

**Default Setting**

None

**Command Mode**

Privileged Exec

**Command Usage**

- The MAC Address Table contains the MAC addresses associated with each interface. Note that the Type field may include the following types:
  - Learned - Dynamic address entries
  - Permanent - Static entry
  - Delete-on-reset - Static entry to be deleted when system is reset
- The mask should be hexadecimal numbers (representing an equivalent bit mask) in the form xx-xx-xx-xx-xx-xx that is applied to the specified MAC address. Enter hexadecimal numbers, where an equivalent binary bit “0” means to match a bit and “1” means to ignore a bit. For example, a mask of 00-00-00-00-00-00 means an exact match, and a mask of FF-FF-FF-FF-FF-FF means “any.”
- The maximum number of address entries is 8191.

**Example**

```
Console#show mac-address-table
Interface Mac Address      Vlan Type
-----
Eth 1/1 00-12-cf-94-34-de  1 Delete-on-reset
Trunk 2 00-12-cf-8f-aa-1b  1 Learned
Console#
```

## 4 Command Line Interface

### **mac-address-table aging-time**

This command sets the aging time for entries in the address table. Use the **no** form to restore the default aging time.

#### **Syntax**

**mac-address-table aging-time** *seconds*

**no mac-address-table aging-time**

*seconds* - Aging time. (Range: 10-30000 seconds; 0 to disable aging)

#### **Default Setting**

300 seconds

#### **Command Mode**

Global Configuration

#### **Command Usage**

The aging time is used to age out dynamically learned forwarding information.

#### **Example**

```
Console(config)#mac-address-table aging-time 100
Console(config)#
```

### **show mac-address-table aging-time**

This command shows the aging time for entries in the address table.

#### **Default Setting**

None

#### **Command Mode**

Privileged Exec

#### **Example**

```
Console#show mac-address-table aging-time
Aging time: 100 sec.
Console#
```

## Spanning Tree Commands

This section includes commands that configure the Spanning Tree Algorithm (STA) globally for the switch, and commands that configure STA for the selected interface.

**Table 4-64 Spanning Tree Commands**

Command	Function	Mode	Page
spanning-tree	Enables the spanning tree protocol	GC	4-226
spanning-tree mode	Configures STP, RSTP or MSTP mode	GC	4-227
spanning-tree forward-time	Configures the spanning tree bridge forward time	GC	4-228
spanning-tree hello-time	Configures the spanning tree bridge hello time	GC	4-228
spanning-tree max-age	Configures the spanning tree bridge maximum age	GC	4-229
spanning-tree priority	Configures the spanning tree bridge priority	GC	4-230
spanning-tree system-bpdu-flooding	Floods BPDUs to all other ports or just to all other ports in the same VLAN when global spanning tree is disabled	GC	4-230
spanning-tree path-cost method	Configures the path cost method for RSTP/MSTP	GC	4-231
spanning-tree transmission-limit	Configures the transmission limit for RSTP/MSTP	GC	4-231
spanning-tree mst-configuration	Changes to MSTP configuration mode	GC	4-232
mst vlan	Adds VLANs to a spanning tree instance	MST	4-232
mst priority	Configures the priority of a spanning tree instance	MST	4-233
name	Configures the name for the multiple spanning tree	MST	4-234
revision	Configures the revision number for the multiple spanning tree	MST	4-234
max-hops	Configures the maximum number of hops allowed in the region before a BPDU is discarded	MST	4-235
spanning-tree spanning-disabled	Disables spanning tree for an interface	IC	4-235
spanning-tree cost	Configures the spanning tree path cost of an interface	IC	4-236
spanning-tree port-priority	Configures the spanning tree priority of an interface	IC	4-237
spanning-tree edge-port	Enables fast forwarding for edge ports	IC	4-238
spanning-tree portfast	Sets an interface to fast forwarding	IC	4-239
spanning-tree port-bpdu-flooding	Floods BPDUs to other ports when global spanning tree is disabled	IC	4-239
spanning-tree link-type	Configures the link type for RSTP/MSTP	IC	4-240
spanning-tree loopback-detection	Enables BPDU loopback detection for the port	IC	4-241
spanning-tree loopback-detection release-mode	Configures loopback release mode for the port	IC	4-241
spanning-tree loopback-detection trap	Enables BPDU loopback SNMP trap notification for the port	IC	4-242

**Table 4-64 Spanning Tree Commands** (Continued)

Command	Function	Mode	Page
spanning-tree mst cost	Configures the path cost of an instance in the MST	IC	4-243
spanning-tree mst port-priority	Configures the priority of an instance in the MST	IC	4-244
spanning-tree protocol-migration	Re-checks the appropriate BPDU format	PE	4-244
show spanning-tree	Shows spanning tree configuration for the common spanning tree (i.e., overall bridge), a selected interface, or an instance within the multiple spanning tree	PE	4-245
show spanning-tree mst configuration	Shows the multiple spanning tree configuration	PE	4-247

## spanning-tree

This command enables the Spanning Tree Algorithm globally for the switch. Use the **no** form to disable it.

### Syntax

**[no] spanning-tree**

### Default Setting

Spanning tree is enabled.

### Command Mode

Global Configuration

### Command Usage

The Spanning Tree Algorithm (STA) can be used to detect and disable network loops, and to provide backup links between switches, bridges or routers. This allows the switch to interact with other bridging devices (that is, an STA-compliant switch, bridge or router) in your network to ensure that only one route exists between any two stations on the network, and provide backup links which automatically take over when a primary link goes down.

### Example

This example shows how to enable the Spanning Tree Algorithm for the switch:

```
Console(config)#spanning-tree
Console(config)#
```

## spanning-tree mode

This command selects the spanning tree mode for this switch. Use the **no** form to restore the default.

### Syntax

```
spanning-tree mode {stp | rstp | mstp}  
no spanning-tree mode
```

- **stp** - Spanning Tree Protocol (IEEE 802.1D)
- **rstp** - Rapid Spanning Tree Protocol (IEEE 802.1w)
- **mstp** - Multiple Spanning Tree (IEEE 802.1s)

### Default Setting

rstp

### Command Mode

Global Configuration

### Command Usage

- Spanning Tree Protocol  
Uses RSTP for the internal state machine, but sends only 802.1D BPDUs.
  - This creates one spanning tree instance for the entire network. If multiple VLANs are implemented on a network, the path between specific VLAN members may be inadvertently disabled to prevent network loops, thus isolating group members. When operating multiple VLANs, we recommend selecting the MSTP option.
- Rapid Spanning Tree Protocol  
RSTP supports connections to either STP or RSTP nodes by monitoring the incoming protocol messages and dynamically adjusting the type of protocol messages the RSTP node transmits, as described below:
  - STP Mode – If the switch receives an 802.1D BPDU after a port's migration delay timer expires, the switch assumes it is connected to an 802.1D bridge and starts using only 802.1D BPDUs.
  - RSTP Mode – If RSTP is using 802.1D BPDUs on a port and receives an RSTP BPDU after the migration delay expires, RSTP restarts the migration delay timer and begins using RSTP BPDUs on that port.
- Multiple Spanning Tree Protocol
  - To allow multiple spanning trees to operate over the network, you must configure a related set of bridges with the same MSTP configuration, allowing them to participate in a specific set of spanning tree instances.
  - A spanning tree instance can exist only on bridges that have compatible VLAN instance assignments.
  - Be careful when switching between spanning tree modes. Changing modes stops all spanning-tree instances for the previous mode and restarts the system in the new mode, temporarily disrupting user traffic.

### Example

The following example configures the switch to use Rapid Spanning Tree:

```
Console(config)#spanning-tree mode rstp
Console(config)#
```

### spanning-tree forward-time

This command configures the spanning tree bridge forward time globally for this switch. Use the **no** form to restore the default.

#### Syntax

**spanning-tree forward-time** *seconds*

**no spanning-tree forward-time**

*seconds* - Time in seconds. (Range: 4 - 30 seconds)

The minimum value is the higher of 4 or  $[(\text{max-age} / 2) + 1]$ .

#### Default Setting

15 seconds

#### Command Mode

Global Configuration

#### Command Usage

This command sets the maximum time (in seconds) the root device will wait before changing states (i.e., discarding to learning to forwarding). This delay is required because every device must receive information about topology changes before it starts to forward frames. In addition, each port needs time to listen for conflicting information that would make it return to the discarding state; otherwise, temporary data loops might result.

### Example

```
Console(config)#spanning-tree forward-time 20
Console(config)#
```

### spanning-tree hello-time

This command configures the spanning tree bridge hello time globally for this switch. Use the **no** form to restore the default.

#### Syntax

**spanning-tree hello-time** *time*

**no spanning-tree hello-time**

*time* - Time in seconds. (Range: 1-10 seconds).

The maximum value is the lower of 10 or  $[(\text{max-age} / 2) - 1]$ .

#### Default Setting

2 seconds

## Command Mode

Global Configuration

## Command Usage

This command sets the time interval (in seconds) at which the root device transmits a configuration message.

## Example

```
Console(config)#spanning-tree hello-time 5
Console(config)#
```

## Related Commands

spanning-tree forward-time (4-228)  
spanning-tree max-age (4-229)

## spanning-tree max-age

This command configures the spanning tree bridge maximum age globally for this switch. Use the **no** form to restore the default.

## Syntax

**spanning-tree max-age** *seconds*  
**no spanning-tree max-age**

*seconds* - Time in seconds. (Range: 6-40 seconds)

The minimum value is the higher of 6 or [2 x (hello-time + 1)].

The maximum value is the lower of 40 or [2 x (forward-time - 1)].

## Default Setting

20 seconds

## Command Mode

Global Configuration

## Command Usage

This command sets the maximum time (in seconds) a device can wait without receiving a configuration message before attempting to reconfigure. All device ports (except for designated ports) should receive configuration messages at regular intervals. Any port that ages out STA information (provided in the last configuration message) becomes the designated port for the attached LAN. If it is a root port, a new root port is selected from among the device ports attached to the network.

## Example

```
Console(config)#spanning-tree max-age 40
Console(config)#
```

## 4 Command Line Interface

### Related Commands

spanning-tree forward-time (4-228)  
spanning-tree hello-time (4-228)

### spanning-tree priority

This command configures the spanning tree priority globally for this switch. Use the **no** form to restore the default.

### Syntax

**spanning-tree priority** *priority*  
**no spanning-tree priority**

*priority* - Priority of the bridge. (Range: 0 - 65535)  
(Range – 0-61440, in steps of 4096; Options: 0, 4096, 8192, 12288, 16384, 20480, 24576, 28672, 32768, 36864, 40960, 45056, 49152, 53248, 57344, 61440)

### Default Setting

32768

### Command Mode

Global Configuration

### Command Usage

Bridge priority is used in selecting the root device, root port, and designated port. The device with the highest priority (i.e., lower numeric value) becomes the STA root device. However, if all devices have the same priority, the device with the lowest MAC address will then become the root device.

### Example

```
Console(config)#spanning-tree priority 40000  
Console(config)#
```

### spanning-tree system-bpdu-flooding

This command configures the system to flood BPDUs to all other ports on the switch or just to all other ports in the same VLAN when spanning tree is disabled globally on the switch or disabled on a specific port. Use the **no** form to restore the default.

### Syntax

**spanning-tree system-bpdu-flooding** {**to-all** | **to-vlan**}  
**no spanning-tree system-bpdu-flooding**

- **to-all** - Floods BPDUs to all other ports on the switch.
- **to-vlan** - Floods BPDUs to all other ports within the receiving port's native VLAN (i.e., as determined by port's PVID).

### Default Setting

Floods to all other ports in the same VLAN.



## Command Mode

Global Configuration

## Command Usage

The **spanning-tree system-bpdu-flooding** command has no effect if BPDU flooding is disabled on a port (see the **spanning-tree port-bpdu-flooding** command, page 4-239).

## Example

```
Console(config)#spanning-tree system-bpdu-flooding
Console(config)#
```

## spanning-tree pathcost method

This command configures the path cost method used for Rapid Spanning Tree and Multiple Spanning Tree. Use the **no** form to restore the default.

## Syntax

**spanning-tree pathcost method {long | short}**

**no spanning-tree pathcost method**

- **long** - Specifies 32-bit based values that range from 1-200,000,000. This method is based on the IEEE 802.1w Rapid Spanning Tree Protocol.
- **short** - Specifies 16-bit based values that range from 1-65535. This method is based on the IEEE 802.1 Spanning Tree Protocol.

## Default Setting

Long method

## Command Mode

Global Configuration

## Command Usage

The path cost method is used to determine the best path between devices. Therefore, lower values should be assigned to ports attached to faster media, and higher values assigned to ports with slower media. Note that path cost (page 4-236) takes precedence over port priority (page 4-237).

## Example

```
Console(config)#spanning-tree pathcost method long
Console(config)#
```

## spanning-tree transmission-limit

This command configures the minimum interval between the transmission of consecutive RSTP/MSTP BPDUs. Use the **no** form to restore the default.

## Syntax

**spanning-tree transmission-limit *count***

**no spanning-tree transmission-limit**

*count* - The transmission limit in seconds. (Range: 1-10)

## 4 Command Line Interface

### Default Setting

3

### Command Mode

Global Configuration

### Command Usage

This command limits the maximum transmission rate for BPDUs.

### Example

```
Console(config)#spanning-tree transmission-limit 4
Console(config)#
```

### spanning-tree mst configuration

This command changes to Multiple Spanning Tree (MST) configuration mode.

### Default Setting

- No VLANs are mapped to any MST instance.
- The region name is set the switch's MAC address.

### Command Mode

Global Configuration

### Example

```
Console(config)#spanning-tree mst configuration
Console(config-mstp)#
```

### Related Commands

mst vlan (4-232)  
mst priority (4-233)  
name (4-234)  
revision (4-234)  
max-hops (4-235)

### mst vlan

This command adds VLANs to a spanning tree instance. Use the **no** form to remove the specified VLANs. Using the **no** form without any VLAN parameters to remove all VLANs.

### Syntax

**[no] mst instance\_id vlan vlan-range**

- *instance\_id* - Instance identifier of the spanning tree. (Range: 0-4094)
- *vlan-range* - Range of VLANs. (Range: 1-4094)

### Default Setting

none

## Command Mode

MST Configuration

## Command Usage

- Use this command to group VLANs into spanning tree instances. MSTP generates a unique spanning tree for each instance. This provides multiple pathways across the network, thereby balancing the traffic load, preventing wide-scale disruption when a bridge node in a single instance fails, and allowing for faster convergence of a new topology for the failed instance.
- By default all VLANs are assigned to the Internal Spanning Tree (MSTI 0) that connects all bridges and LANs within the MST region. This switch supports up to 58 instances. You should try to group VLANs which cover the same general area of your network. However, remember that you must configure all bridges within the same MSTI Region (page 4-234) with the same set of instances, and the same instance (on each bridge) with the same set of VLANs. Also, note that RSTP treats each MSTI region as a single node, connecting all regions to the Common Spanning Tree.

## Example

```
Console(config-mstp)#mst 1 vlan 2-5
Console(config-mstp)#
```

## mst priority

This command configures the priority of a spanning tree instance. Use the **no** form to restore the default.

## Syntax

**mst** *instance\_id* **priority** *priority*  
**no mst** *instance\_id* **priority**

- *instance\_id* - Instance identifier of the spanning tree. (Range: 0-4094)
- *priority* - Priority of the a spanning tree instance.  
(Range: 0-61440 in steps of 4096; Options: 0, 4096, 8192, 12288, 16384, 20480, 24576, 28672, 32768, 36864, 40960, 45056, 49152, 53248, 57344, 61440)

## Default Setting

32768

## Command Mode

MST Configuration

## Command Usage

- MST priority is used in selecting the root bridge and alternate bridge of the specified instance. The device with the highest priority (i.e., lowest numerical value) becomes the MSTI root device. However, if all devices have the same priority, the device with the lowest MAC address will then become the root device.

## 4 Command Line Interface

- You can set this switch to act as the MSTI root device by specifying a priority of 0, or as the MSTI alternate device by specifying a priority of 16384.

### Example

```
Console(config-mstp)#mst 1 priority 4096
Console(config-mstp)#
```

### name

This command configures the name for the multiple spanning tree region in which this switch is located. Use the **no** form to clear the name.

### Syntax

**name** *name*

*name* - Name of the spanning tree.

### Default Setting

Switch's MAC address

### Command Mode

MST Configuration

### Command Usage

The MST region name and revision number (page 4-234) are used to designate a unique MST region. A bridge (i.e., spanning-tree compliant device such as this switch) can only belong to one MST region. And all bridges in the same region must be configured with the same MST instances.

### Example

```
Console(config-mstp)#name R&D
Console(config-mstp)#
```

### Related Commands

revision (4-234)

### revision

This command configures the revision number for this multiple spanning tree configuration of this switch. Use the **no** form to restore the default.

### Syntax

**revision** *number*

*number* - Revision number of the spanning tree. (Range: 0-65535)

### Default Setting

0

### Command Mode

MST Configuration

## Command Usage

The MST region name (page 4-234) and revision number are used to designate a unique MST region. A bridge (i.e., spanning-tree compliant device such as this switch) can only belong to one MST region. And all bridges in the same region must be configured with the same MST instances.

## Example

```
Console(config-mstp)#revision 1
Console(config-mstp)#
```

## Related Commands

name (4-234)

## max-hops

This command configures the maximum number of hops in the region before a BPDU is discarded. Use the **no** form to restore the default.

## Syntax

**max-hops** *hop-number*

*hop-number* - Maximum hop number for multiple spanning tree.  
(Range: 1-40)

## Default Setting

20

## Command Mode

MST Configuration

## Command Usage

An MSTI region is treated as a single node by the STP and RSTP protocols. Therefore, the message age for BPDUs inside an MSTI region is never changed. However, each spanning tree instance within a region, and the internal spanning tree (IST) that connects these instances use a hop count to specify the maximum number of bridges that will propagate a BPDU. Each bridge decrements the hop count by one before passing on the BPDU. When the hop count reaches zero, the message is dropped.

## Example

```
Console(config-mstp)#max-hops 30
Console(config-mstp)#
```

## spanning-tree spanning-disabled

This command disables the spanning tree algorithm for the specified interface. Use the **no** form to reenables the spanning tree algorithm for the specified interface.

## Syntax

**[no] spanning-tree spanning-disabled**

## Default Setting

Enabled

## Command Mode

Interface Configuration (Ethernet, Port Channel)

## Example

This example disables the spanning tree algorithm for port 5.

```
Console(config)#interface ethernet 1/5
Console(config-if)#spanning-tree spanning-disabled
Console(config-if)#
```

## spanning-tree cost

This command configures the spanning tree path cost for the specified interface. Use the **no** form to restore the default.

## Syntax

**spanning-tree cost** *cost*

**no spanning-tree cost**

*cost* - The path cost for the port. (Range: 1-200,000,000)  
 (Range: 0 for auto-configuration, 1-65535 for short path cost method<sup>27</sup>,  
 1-200,000,000 for long path cost method)

**Table 4-65 Recommended STA Path Cost Range**

Port Type	IEEE 802.1D-1998	IEEE 802.1w-2001
Ethernet	50-600	200,000-20,000,000
Fast Ethernet	10-60	20,000-2,000,000
Gigabit Ethernet	3-10	2,000-200,000

**Table 4-66 Recommended STA Path Cost**

Port Type	Link Type	IEEE 802.1D-1998	IEEE 802.1w-2001
Ethernet	Half Duplex	100	2,000,000
	Full Duplex	95	1,999,999
	Trunk	90	1,000,000
Fast Ethernet	Half Duplex	19	200,000
	Full Duplex	18	100,000
	Trunk	15	50,000
Gigabit Ethernet	Full Duplex	4	10,000
	Trunk	3	5,000

<sup>27</sup>. Use the spanning-tree pathcost method command on page 4-231 to set the path cost method.

## Default Setting

By default, the system automatically detects the speed and duplex mode used on each port, and configures the path cost according to the values shown below. Path cost “0” is used to indicate auto-configuration mode. When the short path cost method is selected and the default path cost recommended by the IEEE 8021w standard exceeds 65,535, the default is set to 65,535.

**Table 4-67 Default STA Path Costs**

Port Type	Link Type	IEEE 802.1w-2001
Ethernet	Half Duplex	2,000,000
	Full Duplex	1,000,000
	Trunk	500,000
Fast Ethernet	Half Duplex	200,000
	Full Duplex	100,000
	Trunk	50,000
Gigabit Ethernet	Full Duplex	10,000
	Trunk	5,000

## Command Mode

Interface Configuration (Ethernet, Port Channel)

## Command Usage

- This command is used by the Spanning Tree Algorithm to determine the best path between devices. Therefore, lower values should be assigned to ports attached to faster media, and higher values assigned to ports with slower media.
- Path cost takes precedence over port priority.
- When the spanning-tree pathcost method (page 4-231) is set to short, the maximum value for path cost is 65,535.

## Example

```
Console(config)#interface ethernet 1/5
Console(config-if)#spanning-tree cost 50
Console(config-if)#
```

## spanning-tree port-priority

This command configures the priority for the specified interface. Use the **no** form to restore the default.

## Syntax

**spanning-tree port-priority** *priority*  
**no spanning-tree port-priority**

*priority* - The priority for a port. (Range: 0-240, in steps of 16)

## Default Setting

128

## 4 Command Line Interface

### Command Mode

Interface Configuration (Ethernet, Port Channel)

### Command Usage

- This command defines the priority for the use of a port in the Spanning Tree Algorithm. If the path cost for all ports on a switch are the same, the port with the highest priority (that is, lowest value) will be configured as an active link in the spanning tree.
- Where more than one port is assigned the highest priority, the port with lowest numeric identifier will be enabled.

### Example

```
Console(config)#interface ethernet 1/5
Console(config-if)#spanning-tree port-priority 0
```

### Related Commands

spanning-tree cost (4-236)

### spanning-tree edge-port

This command specifies an interface as an edge port. Use the **no** form to restore the default.

### Syntax

**[no] spanning-tree edge-port**

### Default Setting

Disabled

### Command Mode

Interface Configuration (Ethernet, Port Channel)

### Command Usage

- You can enable this option if an interface is attached to a LAN segment that is at the end of a bridged LAN or to an end node. Since end nodes cannot cause forwarding loops, they can pass directly through to the spanning tree forwarding state. Specifying Edge Ports provides quicker convergence for devices such as workstations or servers, retains the current forwarding database to reduce the amount of frame flooding required to rebuild address tables during reconfiguration events, does not cause the spanning tree to initiate reconfiguration when the interface changes state, and also overcomes other STA-related timeout problems. However, remember that Edge Port should only be enabled for ports connected to an end-node device.
- This command has the same effect as the **spanning-tree portfast**.

### Example

```
Console(config)#interface ethernet 1/5
Console(config-if)#spanning-tree edge-port
Console(config-if)#
```



## Related Commands

spanning-tree portfast (4-239)

### spanning-tree portfast

This command sets an interface to fast forwarding. Use the **no** form to disable fast forwarding.

#### Syntax

[no] spanning-tree portfast

#### Default Setting

Disabled

#### Command Mode

Interface Configuration (Ethernet, Port Channel)

#### Command Usage

- This command is used to enable/disable the fast spanning-tree mode for the selected port. In this mode, ports skip the Discarding and Learning states, and proceed straight to Forwarding.
- Since end-nodes cannot cause forwarding loops, they can be passed through the spanning tree state changes more quickly than allowed by standard convergence time. Fast forwarding can achieve quicker convergence for end-node workstations and servers, and also overcome other STA related timeout problems. (Remember that fast forwarding should only be enabled for ports connected to a LAN segment that is at the end of a bridged LAN or for an end-node device.)
- This command is the same as **spanning-tree edge-port**, and is only included for backward compatibility with earlier products. Note that this command may be removed for future software versions.

#### Example

```
Console(config)#interface ethernet 1/5
Console(config-if)#bridge-group 1 portfast
Console(config-if)#
```

## Related Commands

spanning-tree edge-port (4-238)

### spanning-tree port-bpdu-flooding

This command floods BPDUs to other ports when spanning tree is disabled globally or disabled on a specific port. Use the **no** form to restore the default setting.

#### Syntax

[no] spanning-tree port-bpdu-flooding

#### Default Setting

Enabled

### Command Mode

Interface Configuration (Ethernet, Port Channel)

### Command Usage

- When enabled, BPDUs are flooded to all other ports on the switch or to all other ports within the receiving port's native VLAN as specified by the **spanning-tree system-bpdu-flooding** command (page 4-230).
- The **spanning-tree system-bpdu-flooding** command has no effect if BPDU flooding is disabled on a port by the **spanning-tree port-bpdu-flooding** command.

### Example

```
Console(config)#interface ethernet 1/5
Console(config-if)#spanning-tree port-bpdu-flooding
Console(config-if)#
```

### spanning-tree link-type

This command configures the link type for Rapid Spanning Tree and Multiple Spanning Tree. Use the **no** form to restore the default.

### Syntax

**spanning-tree link-type {auto | point-to-point | shared}**  
**no spanning-tree link-type**

- **auto** - Automatically derived from the duplex mode setting.
- **point-to-point** - Point-to-point link.
- **shared** - Shared medium.

### Default Setting

auto

### Command Mode

Interface Configuration (Ethernet, Port Channel)

### Command Usage

- Specify a point-to-point link if the interface can only be connected to exactly one other bridge, or a shared link if it can be connected to two or more bridges.
- When automatic detection is selected, the switch derives the link type from the duplex mode. A full-duplex interface is considered a point-to-point link, while a half-duplex interface is assumed to be on a shared link.
- RSTP only works on point-to-point links between two bridges. If you designate a port as a shared link, RSTP is forbidden. Since MSTP is an extension of RSTP, this same restriction applies.

### Example

```
Console(config)#interface ethernet 1/5
Console(config-if)#spanning-tree link-type point-to-point
Console(config-if)#
```

### spanning-tree loopback-detection

This command enables the detection and response to Spanning Tree loopback BPDU packets on the port. Use the **no** form to disable this feature.

#### Syntax

```
spanning-tree loopback-detection
no spanning-tree loopback-detection
```

#### Default Setting

Enabled

#### Command Mode

Interface Configuration (Ethernet, Port Channel)

#### Command Usage

- If Port Loopback Detection is not enabled and a port receives its own BPDU, then the port will drop the loopback BPDU according to IEEE Standard 802.1w-2001 9.3.4 (Note 1).
- Port Loopback Detection will not be active if Spanning Tree is disabled on the switch.

#### Example

```
Console(config)#interface ethernet 1/5
Console(config-if)#spanning-tree loopback-detection
Console(config-if)#
```

### spanning-tree loopback-detection release-mode

This command configures the release mode for a port that was placed in the discarding state because a loopback BPDU was received. Use the **no** form to restore the default.

#### Syntax

```
spanning-tree loopback-detection release-mode {auto | manual}
no spanning-tree loopback-detection release-mode
```

- **auto** - Allows a port to automatically be released from the discarding state when the loopback state ends.
- **manual** - The port can only be released from the discarding state manually.

#### Default Setting

auto

#### Command Mode

Interface Configuration (Ethernet, Port Channel)

### Command Usage

- If the port is configured for automatic loopback release, then the port will only be returned to the forwarding state if one of the following conditions is satisfied:
  - The port receives any other BPDU except for its own, or;
  - The port's link status changes to link down and then link up again, or;
  - The port ceases to receive its own BPDUs in a forward delay interval.
- If Port Loopback Detection is not enabled and a port receives its own BPDU, then the port will drop the loopback BPDU according to IEEE Standard 802.1w-2001 9.3.4 (Note 1).
- Port Loopback Detection will not be active if Spanning Tree is disabled on the switch.
- When configured for manual release mode, then a link down / up event will not release the port from the discarding state.

### Example

```
Console(config)#interface ethernet 1/5
Console(config-if)#spanning-tree loopback-detection release-mode manual
Console(config-if)#
```

### spanning-tree loopback-detection trap

This command enables SNMP trap notification for Spanning Tree loopback BPDU detections. Use the **no** form to restore the default.

### Syntax

**spanning-tree loopback-detection trap**  
**no spanning-tree loopback-detection trap**

### Default Setting

Disabled

### Command Mode

Interface Configuration (Ethernet, Port Channel)

### Example

```
Console(config)#interface ethernet ethernet 1/5
Console(config-if)#spanning-tree loopback-detection trap
Console(config-if)#
```

## spanning-tree mst cost

This command configures the path cost on a spanning instance in the Multiple Spanning Tree. Use the **no** form to restore the default.

### Syntax

**spanning-tree mst** *instance\_id* **cost** *cost*

**no spanning-tree mst** *instance\_id* **cost**

- *instance\_id* - Instance identifier of the spanning tree.  
(Range: 0-4094, no leading zeroes)
- *cost* - Path cost for an interface. (Range: 0 for auto-configuration, 1-65535 for short path cost method<sup>28</sup>, 1-200,000,000 for long path cost method)

The recommended path cost range is listed in Table 4-65 on page 4-236. The recommended path cost is listed in Table 4-66 on page 4-236.

### Default Setting

By default, the system automatically detects the speed and duplex mode used on each port, and configures the path cost according to the values shown below. Path cost “0” is used to indicate auto-configuration mode. When the short path cost method is selected and the default path cost recommended by the IEEE 8021w standard exceeds 65,535, the default is set to 65,535. The default path costs are listed in Table 4-67 on page 4-237.

### Command Mode

Interface Configuration (Ethernet, Port Channel)

### Command Usage

- Each spanning-tree instance is associated with a unique set of VLAN IDs.
- This command is used by the multiple spanning-tree algorithm to determine the best path between devices. Therefore, lower values should be assigned to interfaces attached to faster media, and higher values assigned to interfaces with slower media.
- Use the **no spanning-tree mst cost** command to specify auto-configuration mode.
- Path cost takes precedence over interface priority.

### Example

```
Console(config)#interface ethernet ethernet 1/5
Console(config-if)#spanning-tree mst 1 cost 50
Console(config-if)#
```

### Related Commands

spanning-tree mst port-priority (4-244)

28. Use the spanning-tree pathcost method command on page 4-231 to set the path cost method.

### spanning-tree mst port-priority

This command configures the interface priority on a spanning instance in the Multiple Spanning Tree. Use the **no** form to restore the default.

#### Syntax

```
spanning-tree mst instance_id port-priority priority  
no spanning-tree mst instance_id port-priority
```

- *instance\_id* - Instance identifier of the spanning tree.  
(Range: 0-4094, no leading zeroes)
- *priority* - Priority for an interface. (Range: 0-240 in steps of 16)

#### Default Setting

128

#### Command Mode

Interface Configuration (Ethernet, Port Channel)

#### Command Usage

- This command defines the priority for the use of an interface in the multiple spanning-tree. If the path cost for all interfaces on a switch are the same, the interface with the highest priority (that is, lowest value) will be configured as an active link in the spanning tree.
- Where more than one interface is assigned the highest priority, the interface with lowest numeric identifier will be enabled.

#### Example

```
Console(config)#interface ethernet ethernet 1/5  
Console(config-if)#spanning-tree mst 1 port-priority 0  
Console(config-if)#
```

#### Related Commands

spanning-tree mst cost (4-243)

### spanning-tree protocol-migration

This command re-checks the appropriate BPDU format to send on the selected interface.

#### Syntax

```
spanning-tree protocol-migration interface  
interface
```

- **ethernet** *unit/port*
  - *unit* - Stack unit. (Range: 1)
  - *port* - Port number. (Range: 1-28)
- **port-channel** *channel-id* (Range: 1-8)

#### Command Mode

Privileged Exec

## Command Usage

If at any time the switch detects STP BPDUs, including Configuration or Topology Change Notification BPDUs, it will automatically set the selected interface to forced STP-compatible mode. However, you can also use the **spanning-tree protocol-migration** command at any time to manually re-check the appropriate BPDU format to send on the selected interfaces (i.e., RSTP or STP-compatible).

## Example

```
Console#spanning-tree protocol-migration eth 1/5
Console#
```

## show spanning-tree

This command shows the configuration for the common spanning tree (CST) or for an instance within the multiple spanning tree (MST).

## Syntax

**show spanning-tree** [*interface* | **mst** *instance\_id*]

- *interface*
  - **ethernet** *unit/port*
    - *unit* - Stack unit. (Range: 1)
    - *port* - Port number. (Range: 1-28)
  - **port-channel** *channel-id* (Range: 1-8)
- *instance\_id* - Instance identifier of the multiple spanning tree. (Range: 0-4094, no leading zeroes)

## Default Setting

None

## Command Mode

Privileged Exec

## Command Usage

- Use the **show spanning-tree** command with no parameters to display the spanning tree configuration for the switch for the Common Spanning Tree (CST) and for every interface in the tree.
- Use the **show spanning-tree interface** command to display the spanning tree configuration for an interface within the Common Spanning Tree (CST).
- Use the **show spanning-tree mst instance\_id** command to display the spanning tree configuration for an instance within the Multiple Spanning Tree (MST).
- For a description of the items displayed under “Spanning-tree information,” see “Configuring Global Settings” on page 3-167. For a description of the items displayed for specific interfaces, see “Displaying Interface Settings” on page 3-171.

## Example

```
Console#show spanning-tree
Spanning-tree information
-----
Spanning tree mode:                MSTP
Spanning tree enable/disable:      enable
Instance:                           0
Vlans configuration:                1-4092
Priority:                            32768
Bridge Hello Time (sec.):           2
Bridge Max Age (sec.):              20
Bridge Forward Delay (sec.):        15
Root Hello Time (sec.):             2
Root Max Age (sec.):                20
Root Forward Delay (sec.):          15
Max hops:                           20
Remaining hops:                     20
Designated Root:                    32768.0.0000ABCD0000
Current root port:                  1
Current root cost:                   10000
Number of topology changes:         1
Last topology changes time (sec.):  22
Transmission limit:                 3
Path Cost Method:                    long
-----
```

### Eth 1/ 1 information

```
-----
Admin status:                       enable
Role:                                root
State:                               forwarding
External admin path cost:            10000
Internal admin cost:                 10000
External oper path cost:              10000
Internal oper path cost:              10000
Priority:                             128
Designated cost:                     200000
Designated port:                     128.24
Designated root:                     32768.0.0000ABCD0000
Designated bridge:                   32768.0.0030F1552000
Fast forwarding:                     disable
Forward transitions:                  1
Admin edge port:                     enable
Oper edge port:                       disable
Admin Link type:                      auto
Oper Link type:                       point-to-point
Spanning Tree Status:                 enable
:
:
```



## show spanning-tree mst configuration

This command shows the configuration of the multiple spanning tree.

### Command Mode

Privileged Exec

### Example

```

Console#show spanning-tree mst configuration
Mstp Configuration Information
-----
Configuration name: R&D
Revision level:0

Instance Vlans
-----
    0    1,3-4094
    1    2
Console#

```

## VLAN Commands

A VLAN is a group of ports that can be located anywhere in the network, but communicate as though they belong to the same physical segment. This section describes commands used to create VLAN groups, add port members, specify how VLAN tagging is used, and enable automatic VLAN registration for the selected interface.

**Table 4-68 VLANs**

Command Groups	Function	Page
GVRP and Bridge Extension	Configures GVRP settings that permit automatic VLAN learning; shows the configuration for bridge extension MIB	4-248
Editing VLAN Groups	Sets up VLAN groups, including name, VID and state	4-252
Configuring VLAN Interfaces	Configures VLAN interface parameters, including ingress and egress tagging mode, ingress filtering, PVID, and GVRP	4-254
Displaying VLAN Information	Displays VLAN groups, status, port members, and MAC addresses	4-260
Configuring 802.1Q Tunneling	Configures 802.1Q Tunneling (QinQ Tunneling)	4-261
Configuring Port-based Traffic Segmentation	Configures traffic segmentation for different client sessions based on specified downlink and uplink ports	4-265
Configuring Private VLANs	Configures private VLANs, including uplink and downlink ports	4-269
Configuring Protocol VLANs	Configures protocol-based VLANs based on frame type and protocol	4-274
Configuring Voice VLANs	Configures VoIP traffic detection and enables a Voice VLAN	4-277

## GVRP and Bridge Extension Commands

GARP VLAN Registration Protocol defines a way for switches to exchange VLAN information in order to automatically register VLAN members on interfaces across the network. This section describes how to enable GVRP for individual interfaces and globally for the switch, as well as how to display default configuration settings for the Bridge Extension MIB.

**Table 4-69 GVRP and Bridge Extension Commands**

Command	Function	Mode	Page
bridge-ext gvrp	Enables GVRP globally for the switch	GC	4-248
show bridge-ext	Shows the global bridge extension configuration	PE	4-249
switchport gvrp	Enables GVRP for an interface	IC	4-249
switchport forbidden vlan	Configures forbidden VLANs for an interface	IC	4-259
show gvrp configuration	Displays GVRP configuration for the selected interface	NE, PE	4-250
garp timer	Sets the GARP timer for the selected function	IC	4-250
show garp timer	Shows the GARP timer for the selected function	NE, PE	4-251

### bridge-ext gvrp

This command enables GVRP globally for the switch. Use the **no** form to disable it.

### Syntax

**[no] bridge-ext gvrp**

### Default Setting

Disabled

### Command Mode

Global Configuration

### Command Usage

GVRP defines a way for switches to exchange VLAN information in order to register VLAN members on ports across the network. This function should be enabled to permit automatic VLAN registration, and to support VLANs which extend beyond the local switch.

### Example

```
Console(config)#bridge-ext gvrp
Console(config)#
```

## show bridge-ext

This command shows the configuration for bridge extension commands.

### Default Setting

None

### Command Mode

Privileged Exec

### Command Usage

See “Displaying Basic VLAN Information” on page 3-187 and “Displaying Bridge Extension Capabilities” on page 3-16 for a description of the displayed items.

### Example

```
Console#show bridge-ext
Max support vlan numbers:      256
Max support vlan ID:          4094
Extended multicast filtering services: No
Static entry individual port:  Yes
VLAN learning:                 IVL
Configurable PVID tagging:    Yes
Local VLAN capable:           No
Traffic classes:              Enabled
Global GVRP status:           Enabled
GMRP:                          Disabled
Console#
```

## switchport gvrp

This command enables GVRP for a port. Use the **no** form to disable it.

### Syntax

**[no] switchport gvrp**

### Default Setting

Disabled

### Command Mode

Interface Configuration (Ethernet, Port Channel)

### Example

```
Console(config)#interface ethernet 1/6
Console(config-if)#switchport gvrp
Console(config-if)#
```

## 4 Command Line Interface

### show gvrp configuration

This command shows if GVRP is enabled.

#### Syntax

```
show gvrp configuration [interface]
```

*interface*

- **ethernet** *unit/port*
  - *unit* - Stack unit. (Range: 1)
  - *port* - Port number. (Range: 1-28)
- **port-channel** *channel-id* (Range: 1-8)

#### Default Setting

Shows both global and interface-specific configuration.

#### Command Mode

Normal Exec, Privileged Exec

#### Example

```
Console#show gvrp configuration ethernet 1/6
Eth 1/ 6:
  GVRP configuration: Enabled
Console#
```

### garp timer

This command sets the values for the join, leave and leaveall timers. Use the **no** form to restore the timers' default values.

#### Syntax

```
garp timer {join | leave | leaveall} timer_value
no garp timer {join | leave | leaveall}
```

- {*join* | *leave* | *leaveall*} - Which timer to set.
- *timer\_value* - Value of timer.  
Ranges:  
join: 20-1000 centiseconds  
leave: 60-3000 centiseconds  
leaveall: 500-18000 centiseconds

#### Default Setting

- join: 20 centiseconds
- leave: 60 centiseconds
- leaveall: 1000 centiseconds

#### Command Mode

Interface Configuration (Ethernet, Port Channel)

## Command Usage

- Group Address Registration Protocol is used by GVRP and GMRP to register or deregister client attributes for client services within a bridged LAN. The default values for the GARP timers are independent of the media access method or data rate. These values should not be changed unless you are experiencing difficulties with GMRP or GVRP registration/deregistration.
- Timer values are applied to GVRP for all the ports on all VLANs.
- Timer values must meet the following restrictions:
  - leave  $\geq$  (2 x join)
  - leaveall > leave

**Note:** Set GVRP timers on all Layer 2 devices connected in the same network to the same values. Otherwise, GVRP may not operate successfully.

## Example

```
Console(config)#interface ethernet 1/1
Console(config-if)#garp timer join 100
Console(config-if)#
```

## Related Commands

show garp timer (4-251)

## show garp timer

This command shows the GARP timers for the selected interface.

## Syntax

**show garp timer** [*interface*]

*interface*

- **ethernet** *unit/port*
  - *unit* - Stack unit. (Range: 1)
  - *port* - Port number. (Range: 1-28)
- **port-channel** *channel-id* (Range: 1-8)

## Default Setting

Shows all GARP timers.

## Command Mode

Normal Exec, Privileged Exec

## Example

```
Console#show garp timer ethernet 1/1
Eth 1/ 1 GARP timer status:
Join timer:      100 centiseconds
Leave timer:     60 centiseconds
Leaveall timer: 1000 centiseconds
Console#
```

## Related Commands

garp timer (4-250)

## Editing VLAN Groups

Table 4-70 Editing VLAN Groups

Command	Function	Mode	Page
vlan database	Enters VLAN database mode to add, change, and delete VLANs	GC	4-252
vlan	Configures a VLAN, including VID, name and state	VC	4-253

### vlan database

This command enters VLAN database mode. All commands in this mode will take effect immediately.

### Default Setting

None

### Command Mode

Global Configuration

### Command Usage

- Use the VLAN database command mode to add, change, and delete VLANs. After finishing configuration changes, you can display the VLAN settings by entering the **show vlan** command.
- Use the **interface vlan** command mode to define the port membership mode and add or remove ports from a VLAN. The results of these commands are written to the running-configuration file, and you can display this file by entering the **show running-config** command.

### Example

```
Console(config)#vlan database
Console(config-vlan)#
```

### Related Commands

show vlan (4-260)

## vlan

This command configures a VLAN. Use the **no** form to restore the default settings or delete a VLAN.

### Syntax

```
vlan vlan-id [name vlan-name] media ethernet [state {active | suspend}]  
no vlan vlan-id [name | state]
```

- *vlan-id* - ID of configured VLAN. (Range: 1-4092, no leading zeroes)
- **name** - Keyword to be followed by the VLAN name.
  - *vlan-name* - ASCII string from 1 to 32 characters.
- **media ethernet** - Ethernet media type.
- **state** - Keyword to be followed by the VLAN state.
  - **active** - VLAN is operational.
  - **suspend** - VLAN is suspended. Suspended VLANs do not pass packets.

### Default Setting

By default only VLAN 1 exists and is active.

### Command Mode

VLAN Database Configuration

### Command Usage

- **no vlan** *vlan-id* deletes the VLAN.
- **no vlan** *vlan-id* **name** removes the VLAN name.
- **no vlan** *vlan-id* **state** returns the VLAN to the default state (i.e., active).
- You can configure up to 255 VLANs on the switch.

**Note:** The switch allows 255 user-manageable VLANs. One extra, unmanageable VLAN (VLAN ID 4093) is maintained for switch clustering.

### Example

The following example adds a VLAN, using VLAN ID 105 and name RD5. The VLAN is activated by default.

```
Console(config)#vlan database  
Console(config-vlan)#vlan 105 name RD5 media ethernet  
Console(config-vlan)#
```

### Related Commands

show vlan (4-260)

## Configuring VLAN Interfaces

**Table 4-71 Configuring VLAN Interfaces**

Command	Function	Mode	Page
interface vlan	Enters interface configuration mode for a specified VLAN	GC	4-254
switchport mode	Configures VLAN membership mode for an interface	IC	4-255
switchport acceptable-frame-types	Configures frame types to be accepted by an interface	IC	4-255
switchport ingress-filtering	Enables ingress filtering on an interface	IC	4-256
switchport native vlan	Configures the PVID (native VLAN) of an interface	IC	4-257
switchport allowed vlan	Configures the VLANs associated with an interface	IC	4-258
switchport gvrp	Enables GVRP for an interface	IC	4-249
switchport forbidden vlan	Configures forbidden VLANs for an interface	IC	4-259
switchport priority default	Sets a port priority for incoming untagged frames	IC	4-307

### interface vlan

This command enters interface configuration mode for VLANs, which is used to configure VLAN parameters for a physical interface.

### Syntax

**interface vlan** *vlan-id*

*vlan-id* - ID of the configured VLAN. (Range: 1-4094, no leading zeroes)

### Default Setting

None

### Command Mode

Global Configuration

### Example

The following example shows how to set the interface configuration mode to VLAN 1, and then assign an IP address to the VLAN:

```
Console(config)#interface vlan 1
Console(config-if)#ip address 192.168.1.254 255.255.255.0
Console(config-if)#
```

### Related Commands

shutdown (4-194)



## switchport mode

This command configures the VLAN membership mode for a port. Use the **no** form to restore the default.

### Syntax

```
switchport mode {access | hybrid | trunk | private-vlan}  
no switchport mode
```

- **access** - Specifies an access VLAN interface. The port transmits and receives untagged frames only.
- **hybrid** - Specifies a hybrid VLAN interface. The port may transmit tagged or untagged frames.
- **trunk** - Specifies a port as an end-point for a VLAN trunk. A trunk is a direct link between two switches, so the port transmits tagged frames that identify the source VLAN. Note that frames belonging to the port's default VLAN (i.e., associated with the PVID) are also transmitted as tagged frames.
- **private-vlan** - For an explanation of this command see "switchport mode private-vlan" on page 4-271.

### Default Setting

All ports are in hybrid mode with the PVID set to VLAN 1.

### Command Mode

Interface Configuration (Ethernet, Port Channel)

### Example

The following shows how to set the configuration mode to port 1, and then set the switchport mode to hybrid:

```
Console(config)#interface ethernet 1/1  
Console(config-if)#switchport mode hybrid  
Console(config-if)#
```

### Related Commands

switchport acceptable-frame-types (4-255)

## switchport acceptable-frame-types

This command configures the acceptable frame types for a port. Use the **no** form to restore the default.

### Syntax

```
switchport acceptable-frame-types {all | tagged}  
no switchport acceptable-frame-types
```

- **all** - The port accepts all frames, tagged or untagged.
- **tagged** - The port only receives tagged frames.

## 4 Command Line Interface

### Default Setting

All frame types

### Command Mode

Interface Configuration (Ethernet, Port Channel)

### Command Usage

When set to receive all frame types, any received frames that are untagged are assigned to the default VLAN.

### Example

The following example shows how to restrict the traffic received on port 1 to tagged frames:

```
Console(config)#interface ethernet 1/1
Console(config-if)#switchport acceptable-frame-types tagged
Console(config-if)#
```

### Related Commands

switchport mode (4-255)

### switchport ingress-filtering

This command enables ingress filtering for an interface.

### Syntax

**switchport ingress-filtering**  
**no switchport ingress-filtering**

### Default Setting

Enabled

### Command Mode

Interface Configuration (Ethernet, Port Channel)

### Command Usage

- Ingress filtering only affects tagged frames.
- With ingress filtering enabled, a port will discard received frames tagged for VLANs for which it is not a member.
- Ingress filtering does not affect VLAN independent BPDU frames, such as GVRP or STA. However, they do affect VLAN dependent BPDU frames, such as GMRP.

## Example

The following example shows how to select port 1 and then enable ingress filtering:

```
Console(config)#interface ethernet 1/1
Console(config-if)#switchport ingress-filtering
Console(config-if)#
```

## switchport native vlan

This command configures the PVID (i.e., default VLAN ID) for a port. Use the **no** form to restore the default.

## Syntax

```
switchport native vlan vlan-id
no switchport native vlan
```

*vlan-id* - Default VLAN ID for a port. (Range: 1-4094, no leading zeroes)

## Default Setting

VLAN 1

## Command Mode

Interface Configuration (Ethernet, Port Channel)

## Command Usage

- Setting the native VLAN for a port can only be performed when the port is a member of the VLAN and the VLAN is untagged. The **no switchport native vlan** command will set the native VLAN of the port to untagged VLAN 1.
- If acceptable frame types is set to **all** or switchport mode is set to **hybrid**, the PVID will be inserted into all untagged frames entering the ingress port.

## Example

The following example shows how to set the PVID for port 1 to VLAN 3:

```
Console(config)#interface ethernet 1/1
Console(config-if)#switchport native vlan 3
Console(config-if)#
```

### switchport allowed vlan

This command configures VLAN groups on the selected interface. Use the **no** form to restore the default.

#### Syntax

```
switchport allowed vlan {add vlan-list [tagged | untagged] |  
remove vlan-list}  
no switchport allowed vlan
```

- **add** *vlan-list* - List of VLAN identifiers to add.
- **remove** *vlan-list* - List of VLAN identifiers to remove.
- *vlan-list* - Separate nonconsecutive VLAN identifiers with a comma and no spaces; use a hyphen to designate a range of IDs. Do not enter leading zeros. (Range: 1-4094).

#### Default Setting

All ports are assigned to VLAN 1 by default.  
The default frame type is untagged.

#### Command Mode

Interface Configuration (Ethernet, Port Channel)

#### Command Usage

- A port, or a trunk with switchport mode set to **hybrid**, must be assigned to a VLAN as untagged.
- If a trunk has switchport mode set to **trunk** (i.e., 1Q Trunk), then you can only assign an interface to VLAN groups as a tagged member.
- Frames are always tagged within the switch. The tagged/untagged parameter used when adding a VLAN to an interface tells the switch whether to keep or remove the tag from a frame on egress.
- If none of the intermediate network devices nor the host at the other end of the connection supports VLANs, the interface should be added to these VLANs as an untagged member. Otherwise, it is only necessary to add at most one VLAN as untagged, and this should correspond to the native VLAN for the interface.
- If a VLAN on the forbidden list for an interface is manually added to that interface, the VLAN is automatically removed from the forbidden list for that interface.

#### Example

The following example shows how to add VLANs 1, 2, 5 and 6 to the allowed list as tagged VLANs for port 1:

```
Console(config)#interface ethernet 1/1  
Console(config-if)#switchport allowed vlan add 1,2,5,6 tagged  
Console(config-if)#
```

## switchport forbidden vlan

This command configures forbidden VLANs. Use the **no** form to remove the list of forbidden VLANs.

### Syntax

```
switchport forbidden vlan {add vlan-list | remove vlan-list}  
no switchport forbidden vlan
```

- **add** *vlan-list* - List of VLAN identifiers to add.
- **remove** *vlan-list* - List of VLAN identifiers to remove.
- *vlan-list* - Separate nonconsecutive VLAN identifiers with a comma and no spaces; use a hyphen to designate a range of IDs. Do not enter leading zeros. (Range: 1-4094).

### Default Setting

No VLANs are included in the forbidden list.

### Command Mode

Interface Configuration (Ethernet, Port Channel)

### Command Usage

- This command prevents a VLAN from being automatically added to the specified interface via GVRP.
- If a VLAN has been added to the set of allowed VLANs for an interface, then you cannot add it to the set of forbidden VLANs for that same interface.

### Example

The following example shows how to prevent port 1 from being added to VLAN 3:

```
Console(config)#interface ethernet 1/1  
Console(config-if)#switchport forbidden vlan add 3  
Console(config-if)#
```

## Displaying VLAN Information

Table 4-72 Show VLAN Commands

Command	Function	Mode	Page
show vlan	Shows VLAN information	NE, PE	4-260
show interfaces status vlan	Displays status for the specified VLAN interface	NE, PE	4-196
show interfaces switchport	Displays the administrative and operational status of an interface	NE, PE	4-199

### show vlan

This command shows VLAN information.

### Syntax

**show vlan** [*id* *vlan-id* | **name** *vlan-name* | **private-vlan** [*private-vlan-type*]]

- **id** - Keyword to be followed by the VLAN ID.  
*vlan-id* - ID of the configured VLAN. (Range: 1-4094, no leading zeroes)
- **name** - Keyword to be followed by the VLAN name.  
*vlan-name* - ASCII string from 1 to 32 characters.
- **private-vlan** - For an explanation of this command see “show vlan private-vlan” on page 4-273  
*private-vlan-type* - Indicates the private vlan type.  
(Options: community, primary)

### Default Setting

Shows all VLANs.

### Command Mode

Normal Exec, Privileged Exec

### Example

The following example shows how to display information for VLAN 1:

```

Console#show vlan id 1
Default VLAN ID : 1

VLAN ID:          1
Type:             Static
Name:            DefaultVlan
Status:          Active
Ports/Port Channels:  Eth1/ 1(S) Eth1/ 2(S) Eth1/ 3(S) Eth1/ 4(S) Eth1/ 5(S)
                    Eth1/ 6(S) Eth1/ 7(S) Eth1/ 8(S) Eth1/ 9(S) Eth1/10(S)
                    Eth1/11(S) Eth1/12(S) Eth1/13(S) Eth1/14(S) Eth1/15(S)
                    Eth1/16(S) Eth1/17(S) Eth1/18(S) Eth1/19(S) Eth1/20(S)
                    Eth1/21(S) Eth1/22(S) Eth1/23(S) Eth1/24(S) Eth1/25(S)
                    Eth1/26(S) Eth1/27(S) Eth1/28(S)

Console#

```

## Configuring IEEE 802.1Q Tunneling

IEEE 802.1Q tunneling (QinQ tunneling) uses a single Service Provider VLAN (SPVLAN) for customers who have multiple VLANs. Customer VLAN IDs are preserved and traffic from different customers is segregated within the service provider's network even when they use the same customer-specific VLAN IDs. QinQ tunneling expands VLAN space by using a VLAN-in-VLAN hierarchy, preserving the customer's original tagged packets, and adding SPVLAN tags to each frame (also called double tagging).

This section describes commands used to configure QinQ tunneling.

**Table 4-73 IEEE 802.1Q Tunneling Commands**

Command	Function	Mode	Page
dot1q-tunnel system-tunnel-control	Configures the switch to operate in normal mode or QinQ mode	GC	4-262
switchport dot1q-tunnel mode	Configures an interface as a QinQ tunnel port	IC	4-262
switchport dot1q-tunnel tpid	Sets the Tag Protocol Identifier (TPID) value of a tunnel port	IC	4-263
show dot1q-tunnel	Displays the configuration of QinQ tunnel ports	PE	4-264
show interfaces switchport	Displays port QinQ operational status	PE	4-199

### General Configuration Guidelines for QinQ

1. Configure the switch to QinQ mode (**dot1q-tunnel system-tunnel-control**, page 4-262).
2. Create a SPVLAN (**vlan**, page 4-253).
3. Configure the QinQ tunnel access port to dot1Q-tunnel access mode (**switchport dot1q-tunnel mode**, page 4-262).
4. Set the Tag Protocol Identifier (TPID) value of the tunnel access port. This step is required if the attached client is using a nonstandard 2-byte ethertype to identify 802.1Q tagged frames. The standard ethertype value is 0x8100. (See **switchport dot1q-tunnel tpid**, page 4-263.)
5. Configure the QinQ tunnel access port to join the SPVLAN as an untagged member (**switchport allowed vlan**, page 4-258).
6. Configure the SPVLAN ID as the native VID on the QinQ tunnel access port (**switchport native vlan**, page 4-257).
7. Configure the QinQ tunnel uplink port to dot1Q-tunnel uplink mode (**switchport dot1q-tunnel mode**, page 4-262).
8. Configure the QinQ tunnel uplink port to join the SPVLAN as a tagged member (**switchport allowed vlan**, page 4-258).

### Limitations for QinQ

- The native VLAN for the tunnel uplink ports and tunnel access ports cannot be the same. However, the same service VLANs can be set on both tunnel port types.
- IGMP Snooping should not be enabled on a tunnel access port.
- If the spanning tree protocol is enabled, be aware that a tunnel access or tunnel uplink port may be disabled if the spanning tree structure is automatically

## 4 Command Line Interface

reconfigured to overcome a break in the tree. It is therefore advisable to disable spanning tree on these ports.

### **dot1q-tunnel system-tunnel-control**

This command sets the switch to operate in QinQ mode. Use the **no** form to disable QinQ operating mode.

#### **Syntax**

```
[no] dot1q-tunnel system-tunnel-control
```

#### **Default Setting**

Disabled

#### **Command Mode**

Global Configuration

#### **Command Usage**

QinQ tunnel mode must be enabled on the switch for QinQ interface settings to be functional.

#### **Example**

```
Console(config)#dot1q-tunnel system-tunnel-control  
Console(config)#
```

#### **Related Commands**

```
show dot1q-tunnel (4-264)  
show interfaces switchport (4-199)
```

### **switchport dot1q-tunnel mode**

This command configures an interface as a QinQ tunnel port. Use the **no** form to disable QinQ on the interface.

#### **Syntax**

```
switchport dot1q-tunnel mode {access | uplink}  
no switchport dot1q-tunnel mode
```

- **access** – Sets the port as an 802.1Q tunnel access port.
- **uplink** – Sets the port as an 802.1Q tunnel uplink port.

#### **Default Setting**

Disabled

#### **Command Mode**

Interface Configuration (Ethernet, Port Channel)

#### **Command Usage**

- QinQ tunneling must be enabled on the switch using the **dot1q-tunnel system-tunnel-control** command before the **switchport dot1q-tunnel mode** interface command can take effect.



- When a tunnel uplink port receives a packet from a customer, the customer tag (regardless of whether there are one or more tag layers) is retained in the inner tag, and the service provider's tag added to the outer tag.
- When a tunnel uplink port receives a packet from the service provider, the outer service provider's tag is stripped off, and the packet passed on to the VLAN indicated by the inner tag. If no inner tag is found, the packet is passed onto the native VLAN defined for the uplink port.

### Example

```
Console(config)#interface ethernet 1/1
Console(config-if)#switchport dot1q-tunnel mode access
Console(config-if)#
```

### Related Commands

- show dot1q-tunnel (4-264)
- show interfaces switchport (4-199)

### switchport dot1q-tunnel tpid

This command sets the Tag Protocol Identifier (TPID) value of a tunnel port. Use the **no** form to restore the default setting.

### Syntax

- switchport dot1q-tunnel tpid *tpid***
- no switchport dot1q-tunnel tpid**

*tpid* – Sets the ethertype value for 802.1Q encapsulation. This identifier is used to select a nonstandard 2-byte ethertype to identify 802.1Q tagged frames. The standard ethertype value is 0x8100. (Range: 0800-FFFF hexadecimal)

### Default Setting

0x8100

### Command Mode

Interface Configuration (Ethernet, Port Channel)

### Command Usage

- Use the **switchport dot1q-tunnel tpid** command to set a custom 802.1Q ethertype value on the selected interface. This feature allows the switch to interoperate with third-party switches that do not use the standard 0x8100 ethertype to identify 802.1Q-tagged frames. For example, 0x1234 is set as the custom 802.1Q ethertype on a trunk port, incoming frames containing that ethertype are assigned to the VLAN contained in the tag following the ethertype field, as they would be with a standard 802.1Q trunk. Frames arriving on the port containing any other ethertype are looked upon as untagged frames, and assigned to the native VLAN of that port.
- All ports on the switch will be set to the same ethertype.

## 4 Command Line Interface

### Example

```
Console(config)#interface ethernet 1/1
Console(config-if)#switchport dot1q-tunnel tpid 9100
Console(config-if)#
```

### Related Commands

show interfaces switchport (4-199)

### show dot1q-tunnel

This command displays information about QinQ tunnel ports.

### Command Mode

Privileged Exec

### Example

```
Console(config)#dot1q-tunnel system-tunnel-control
Console(config)#interface ethernet 1/1
Console(config-if)#switchport dot1q-tunnel mode access
Console(config-if)#interface ethernet 1/2
Console(config-if)#switchport dot1q-tunnel mode uplink
Console(config-if)#end
Console#show dot1q-tunnel

Current double-tagged status of the system is Enabled
The dot1q-tunnel mode of the set interface 1/1 is Access mode, TPID is 0x8100.
The dot1q-tunnel mode of the set interface 1/2 is Uplink mode, TPID is 0x8100.
The dot1q-tunnel mode of the set interface 1/3 is Normal mode, TPID is 0x8100.
:
```

### Related Commands

switchport dot1q-tunnel mode (4-262)

## Configuring Port-based Traffic Segmentation

If tighter security is required for passing traffic from different clients through downlink ports on the local network and over uplink ports to the service provider, port-based traffic segmentation can be used to isolate traffic for individual client sessions.

Traffic belonging to each client is isolated to the allocated downlink ports. But the switch can be configured to either isolate traffic passing across a client's allocated uplink ports from the uplink ports assigned to other clients, or to forward traffic through the uplink ports used by other clients, allowing different clients to share access to their uplink ports where security is less likely to be compromised.

This section describes commands used to configure traffic segmentation.

**Table 4-74 Traffic Segmentation Commands**

Command	Function	Mode	Page
pvlan	Enables traffic segmentation	GC	4-265
pvlan uplink/downlink	Configures uplink/downlink ports for client sessions	GC	4-266
pvlan session	Creates a client session	GC	4-267
pvlan up-to-up	Specifies whether or not traffic can be forwarded between uplink ports assigned to different client sessions	GC	4-268
show pvlan	Displays the traffic segmentation configuration settings	PE	4-268

### **pvlan**

This command enables port-based traffic segmentation. Use the **no** form to disable this feature.

### **Syntax**

[no] pvlan

### **Default Setting**

Disabled

### **Command Mode**

Global Configuration

## Command Usage

- When traffic segmentation is enabled, the forwarding state for the uplink and downlink ports assigned to different client sessions is shown below.

**Table 4-75 Traffic Segmentation Forwarding**

Destination Source	Session #1 Downlinks	Session #1 Uplinks	Session #2 Downlinks	Session #2 Uplinks	Normal Ports
Session #1 Downlink Ports	Blocking	Forwarding	Blocking	Blocking	Blocking
Session #1 Uplink Ports	Forwarding	Forwarding	Blocking	Blocking/Forwarding*	Forwarding
Session #2 Downlink Ports	Blocking	Blocking	Blocking	Forwarding	Blocking
Session #2 Uplink Ports	Blocking	Blocking/Forwarding*	Forwarding	Forwarding	Forwarding
Normal Ports	Forwarding	Forwarding	Forwarding	Forwarding	Forwarding

\* The forwarding state for uplink-to-uplink ports is configured by the **pvlan uplink/downlink** command (page 4-266).

- When traffic segmentation is disabled, all ports operate in normal forwarding mode based on the settings specified by other functions such as VLANs and spanning tree protocol.

## Example

```
Console(config)#pvlan
Console(config)#
```

## pvlan uplink/downlink

This command configures uplink/downlink ports for traffic-segmentation client sessions. Use the **no** form to restore a port to normal operating mode.

## Syntax

**[no] pvlan [session session-id] {uplink interface-list [downlink interface-list] | downlink interface-list}**

- session-id* – Traffic segmentation session. (Range: 1-15)
- interface-list* – One or more uplink or downlink interfaces.
  - ethernet** *unit/port*
    - unit* - Stack unit. (Range: 1)
    - port* - Port number. (Range: 1-28)
  - port-channel** *channel-id* (Range: 1-8)

## Default Setting

None

## Command Mode

Global Configuration

### Command Usage

- A port cannot be configured in both an uplink and downlink list.
- A port can only be assigned to one traffic-segmentation session.
- A downlink port can only communicate with an uplink port in the same session. Therefore, if an uplink port is not configured for a session, the assigned downlink ports will not be able to communicate with any other ports.
- If a downlink port is not configured for the session, the assigned uplink ports will operate as normal ports.
- Due to switch ASIC limitations, ports 1-8, 9-16, 17-24 are grouped together when any group member is configured as an uplink or downlink interface.

### Example

```
Console(config)#pvlan session 1 uplink ethernet 1/5 downlink ethernet 1/6
Console(config)#
```

### pvlan session

This command creates a traffic-segmentation client session. Use the **no** form to remove a client session.

### Syntax

**[no] pvlan session session-id**

*session-id* – Traffic segmentation session. (Range: 1-15)

### Default Setting

None

### Command Mode

Global Configuration

### Command Usage

- Use this command to create a new traffic-segmentation client session.
- Using the **no** form of this command will remove any assigned uplink or downlink ports, restoring these interfaces to normal operating mode.

### Example

```
Console(config)#pvlan session 1
Console(config)#
```

## pvlan up-to-up

This command specifies whether or not traffic can be forwarded between uplink ports assigned to different client sessions. Use the **no** form to restore the default.

### Syntax

**[no] pvlan up-to-up {blocking | forwarding}**

- **blocking** – Blocks traffic between uplink ports assigned to different sessions.
- **forwarding** – Forwards traffic between uplink ports assigned to different sessions.

### Default Setting

Blocking

### Command Mode

Global Configuration

### Example

This example enables forwarding of traffic between uplink ports assigned to different client sessions.

```
Console(config)#pvlan up-to-up
Console(config)#
```

## show pvlan

This command displays the traffic segmentation configuration settings.

### Syntax

**show pvlan [session *session-id*]**

*session-id* – Traffic segmentation session. (Range: 1-15)

### Command Mode

Privileged Exec

### Example

```
Console#show pvlan

Private VLAN Status      :      Enabled
Uplink-to-Uplink Mode   :      Blocking

-----
Session  Uplink Ports      Downlink Ports
-----
   1     Ethernet 1/28      Ethernet 1/9
                                   Ethernet 1/10
                                   Ethernet 1/11
Console#
```

## Configuring Private VLANs

Private VLANs provide port-based security and isolation between ports within the assigned VLAN. This switch supports two types of private VLANs: primary/secondary associated groups, and stand-alone isolated VLANs. A primary VLAN contains promiscuous ports that can communicate with all other ports in the private VLAN group, while a secondary (or community) VLAN contains community ports that can only communicate with other hosts within the secondary VLAN and with any of the promiscuous ports in the associated primary VLAN. Isolated VLANs, on the other hand, consist a single stand-alone VLAN that contains one promiscuous port and one or more isolated (or host) ports. In all cases, the promiscuous ports are designed to provide open access to an external network such as the Internet, while the community ports provide restricted access to local users.

Multiple primary VLANs can be configured on this switch, and multiple community VLANs can be associated with each primary VLAN. One or more isolated VLANs can also be configured. (Note that private VLANs and normal VLANs can exist simultaneously within the same switch.)

This section describes commands used to configure private VLANs.

**Table 4-76 Private VLAN Commands**

Command	Function	Mode	Page
<i>Edit Private VLAN Groups</i>			
private-vlan	Adds or deletes primary, community, or isolated VLANs	VC	4-270
private-vlan association	Associates a community VLAN with a primary VLAN	VC	4-271
<i>Configure Private VLAN Interfaces</i>			
switchport mode private-vlan	Sets an interface to host mode or promiscuous mode	IC	4-271
switchport private-vlan host-association	Associates an interface with a secondary VLAN	IC	4-272
switchport private-vlan mapping	Maps an interface to a primary VLAN	IC	4-273
<i>Display Private VLAN Information</i>			
show vlan private-vlan	Shows private VLAN information	NE, PE	4-273

To configure primary/secondary associated groups, follow these steps:

1. Use the **private-vlan** command to designate one or more community VLANs and the primary VLAN that will channel traffic outside of the community groups.
2. Use the **private-vlan association** command to map the community VLAN(s) to the primary VLAN.
3. Use the **switchport mode private-vlan** command to configure ports as promiscuous (i.e., having access to all ports in the primary VLAN) or host (i.e., community port).

## 4 Command Line Interface

4. Use the **switchport private-vlan host-association** command to assign a port to a secondary VLAN.
5. Use the **switchport private-vlan mapping** command to assign a port to a primary VLAN.
6. Use the **show vlan private-vlan** command to verify your configuration settings.

### private-vlan

Use this command to create a primary or community private VLAN. Use the **no** form to remove the specified private VLAN.

### Syntax

```
private-vlan vlan-id {community | primary}  
no private-vlan vlan-id
```

- *vlan-id* - ID of private VLAN. (Range: 1-4092, no leading zeroes).
- **community** - A VLAN in which traffic is restricted to host members in the same VLAN and to promiscuous ports in the associate primary VLAN.
- **primary** - A VLAN which can contain one or more community VLANs, and serves to channel traffic between community VLANs and other locations.

### Default Setting

None

### Command Mode

VLAN Configuration

### Command Usage

- Private VLANs are used to restrict traffic to ports within the same community, and channel traffic passing outside the community through promiscuous ports. When using community VLANs, they must be mapped to an associated “primary” VLAN that contains promiscuous ports.
- Port membership for private VLANs is static. Once a port has been assigned to a private VLAN, it cannot be dynamically moved to another VLAN via GVRP.
- Private VLAN ports cannot be set to trunked mode. (See “switchport mode” on page 4-255.)

### Example

```
Console(config)#vlan database  
Console(config-vlan)#private-vlan 2 primary  
Console(config-vlan)#private-vlan 3 community  
Console(config)#
```



### private vlan association

Use this command to associate a primary VLAN with a secondary (i.e., community) VLAN. Use the **no** form to remove all associations for the specified primary VLAN.

#### Syntax

```
private-vlan primary-vlan-id association {secondary-vlan-id |  
add secondary-vlan-id | remove secondary-vlan-id}
```

**no private-vlan *primary-vlan-id* association**

- *primary-vlan-id* - ID of primary VLAN. (Range: 1-4094, no leading zeroes).
- *secondary-vlan-id* - ID of secondary (i.e., community) VLAN. (Range: 1-4094, no leading zeroes).

#### Default Setting

None

#### Command Mode

VLAN Configuration

#### Command Usage

Secondary VLANs provide security for group members. The associated primary VLAN provides a common interface for access to other network resources within the primary VLAN (e.g., servers configured with promiscuous ports) and to resources outside of the primary VLAN (via promiscuous ports).

#### Example

```
Console(config-vlan)#private-vlan 2 association 3  
Console(config)#
```

### switchport mode private-vlan

Use this command to set the private VLAN mode for an interface. Use the **no** form to restore the default setting.

#### Syntax

```
switchport mode private-vlan {host | promiscuous}  
no switchport mode private-vlan
```

- **host** – This port type can subsequently be assigned to a community VLAN.
- **promiscuous** – This port type can communicate with all other promiscuous ports in the same primary VLAN, as well as with all the ports in the associated secondary VLANs.

#### Default Setting

Normal VLAN

## 4 Command Line Interface

### Command Mode

Interface Configuration (Ethernet, Port Channel)

### Command Usage

- To assign a promiscuous port to a primary VLAN, use the **switchport private-vlan mapping** command. To assign a host port to a community VLAN, use the **private-vlan host association** command.
- To assign a promiscuous port or host port to an isolated VLAN, use the **switchport private-vlan isolated** command.

### Example

```
Console(config)#interface ethernet 1/2
Console(config-if)#switchport mode private-vlan promiscuous
Console(config-if)#exit
Console(config)#interface ethernet 1/3
Console(config-if)#switchport mode private-vlan host
Console(config-if)#
```

### switchport private-vlan host-association

Use this command to associate an interface with a secondary VLAN. Use the **no** form to remove this association.

### Syntax

**switchport private-vlan host-association** *secondary-vlan-id*  
**no switchport private-vlan host-association**

*secondary-vlan-id* - ID of secondary (i.e., community) VLAN.  
(Range: 1-4092, no leading zeroes).

### Default Setting

None

### Command Mode

Interface Configuration (Ethernet, Port Channel)

### Command Usage

All ports assigned to a secondary (i.e., community) VLAN can pass traffic between group members, but must communicate with resources outside of the group via promiscuous ports in the associated primary VLAN.

### Example

```
Console(config)#interface ethernet 1/3
Console(config-if)#switchport private-vlan host-association 3
Console(config-if)#
```

## switchport private-vlan mapping

Use this command to map an interface to a primary VLAN. Use the **no** form to remove this mapping.

### Syntax

```
switchport private-vlan mapping primary-vlan-id  
no switchport private-vlan mapping
```

*primary-vlan-id* – ID of primary VLAN. (Range: 1-4094, no leading zeroes).

### Default Setting

None

### Command Mode

Interface Configuration (Ethernet, Port Channel)

### Command Usage

Promiscuous ports assigned to a primary VLAN can communicate with any other promiscuous ports in the same VLAN, and with the group members within any associated secondary VLANs.

### Example

```
Console(config)#interface ethernet 1/2  
Console(config-if)#switchport private-vlan mapping 2  
Console(config-if)#
```

## show vlan private-vlan

Use this command to show the private VLAN configuration settings on this switch.

### Syntax

```
show vlan private-vlan [community | primary]
```

- **community** – Displays all community VLANs, along with their associated primary VLAN and assigned host interfaces.
- **primary** – Displays all primary VLANs, along with any assigned promiscuous interfaces.

### Default Setting

None

### Command Mode

Privileged Executive

## Example

```

Console#show vlan private-vlan
Primary   Secondary   Type           Interfaces
-----
          5           primary        Eth1/ 3
          5           community     Eth1/ 4 Eth1/ 5
Console#
    
```

## Configuring Protocol-based VLANs

The network devices required to support multiple protocols cannot be easily grouped into a common VLAN. This may require non-standard devices to pass traffic between different VLANs in order to encompass all the devices participating in a specific protocol. This kind of configuration deprives users of the basic benefits of VLANs, including security and easy accessibility.

To avoid these problems, you can configure this switch with protocol-based VLANs that divide the physical network into logical VLAN groups for each required protocol. When a frame is received at a port, its VLAN membership can then be determined based on the protocol type in use by the inbound packets.

**Table 4-77 Protocol-based VLAN Commands**

Command	Function	Mode	Page
protocol-vlan protocol-group	Create a protocol group, specifying the supported protocols	GC	4-275
protocol-vlan protocol-group	Maps a protocol group to a VLAN	GC	4-275
show protocol-vlan protocol-group	Shows the configuration of protocol groups	PE	4-276
show protocol-vlan protocol-group-vid	Shows the mapping of protocol groups to VLAN	PE	4-277

To configure protocol-based VLANs, follow these steps:

1. First configure VLAN groups for the protocols you want to use (page 4-253). Although not mandatory, we suggest configuring a separate VLAN for each major protocol running on your network. Do not add port members at this time.
2. Create a protocol group for each of the protocols you want to assign to a VLAN using the **protocol-vlan protocol-group add** command.
3. Then map the protocol group to the appropriate VLAN using the **protocol-vlan protocol-group vlan** command.

**Note:** Traffic which matches IP Protocol Ethernet Frames is mapped to the VLAN (VLAN 1 by default) that has been configured with the switch’s administrative IP. IP Protocol Ethernet traffic must not be mapped to another VLAN or you will lose administrative network connectivity to the switch. If lost in this manner, network access can be regained by removing the offending Protocol VLAN rule via the console. Alternately, the switch can be power-cycled, however all unsaved configuration changes will be lost.

### protocol-vlan protocol-group (Configuring Groups)

This command creates a protocol group, or adds specific protocols to a group. Only one frame type and protocol type can be added to a protocol group. Use the **no** form to remove a protocol group.

#### Syntax

```
protocol-vlan protocol-group group-id [{add | remove} frame-type frame  
protocol-type protocol]
```

```
no protocol-vlan protocol-group group-id
```

- *group-id* - Group identifier of this protocol group. (Range: 1-2147483647)
- *frame*<sup>29</sup> - Frame type used by this protocol. (Options: ethernet, rfc\_1042, llc\_other)
- *protocol* - Protocol type. The only option for the llc\_other frame type is ipx\_raw. The options for all other frames types include: ip, arp, and rarp.

#### Default Setting

No protocol groups are configured.

#### Command Mode

Global Configuration

#### Example

The following creates protocol group 2, and specifies Ethernet frames transmitting ARP protocol type traffic:

```
Console(config)#protocol-vlan protocol-group 2 add frame-type ethernet  
protocol-type arp  
Console(config)#
```

### protocol-vlan protocol-group (Configuring VLANs)

This command globally maps a protocol group to a VLAN. Use the **no** form to remove the protocol mapping.

#### Syntax

```
protocol-vlan protocol-group group-id vlan vlan-id  
no protocol-vlan protocol-group group-id vlan
```

- *group-id* - Group identifier of this protocol group. (Range: 1-2147483647)
- *vlan-id* - VLAN to which matching protocol traffic is forwarded. (Range: 1-4094)

#### Default Setting

No protocol groups are mapped to any VLANs.

#### Command Mode

Global Configuration

---

29. SNAP frame types are not supported by this switch due to hardware limitations.

## Command Usage

- When creating a protocol-based VLAN, do not assign interfaces to the protocol VLAN via any of the standard VLAN commands. If you assign interfaces using any of the other VLAN commands (such as **vlan** on page 4-253), the switch will admit traffic of any protocol type into the associated VLAN.
- A maximum of 20 protocol VLAN groups can be defined on the switch.
- When a frame enters the switch that has protocol VLANs configured, it is processed in the following manner:
  - If the frame is tagged, it will be processed according to the standard rules applied to tagged frames.
  - If the frame is untagged and the protocol type matches, the frame is forwarded to the appropriate VLAN.
  - If the frame is untagged but the protocol type does not match, the frame is forwarded to the default VLAN for the interface.

## Example

The following example maps traffic matching the protocol type specified in protocol group 2 to VLAN 2.

```
Console(config)#protocol-vlan protocol-group 2 vlan 2
Console(config)#
```

## show protocol-vlan protocol-group

This command shows the frame and protocol type associated with protocol groups.

## Syntax

**show protocol-vlan protocol-group** [*group-id*]

*group-id* - Group identifier for a protocol group. (Range: 1-2147483647)

## Default Setting

All protocol groups are displayed.

## Command Mode

Privileged Exec

## Example

This shows protocol group 2 configured for IP over RFC 1042:

```
Console#show protocol-vlan protocol-group

ProtocolGroup ID   Frame Type   Protocol Type
-----
                  2           RFC 1042    08 00
Console#
```

**show protocol-vlan protocol-group-vid**

This command shows the mapping from protocol groups to VLANs.

**Syntax**

**show protocol-vlan protocol-group-vid**

**Default Setting**

The mapping for all protocol groups is displayed.

**Command Mode**

Privileged Exec

**Example**

This shows that traffic matching the specifications for protocol group 2 will be mapped to VLAN 2:

```

Console#show protocol-vlan protocol-group-vid

ProtocolGroup ID      VLAN ID
-----
                2      VLAN2
Console#

```

**Configuring Voice VLANs**

The switch allows you to specify a Voice VLAN for the network and set a CoS priority for the VoIP traffic. VoIP traffic can be detected on switch ports by using the source MAC address of packets, or by using LLDP (IEEE 802.1AB) to discover connected VoIP devices. When VoIP traffic is detected on a configured port, the switch automatically assigns the port to the Voice VLAN. Alternatively, switch ports can be manually configured.

**Table 4-78 Voice VLAN Commands**

Command	Function	Mode	Page
voice vlan	Defines the Voice VLAN ID	GC	4-278
voice vlan aging	Configures the aging time for Voice VLAN ports	GC	4-278
voice vlan mac-address	Configures VoIP device MAC addresses	GC	4-279
switchport voice vlan	Sets the Voice VLAN port mode	IC	4-280
switchport voice vlan rule	Sets the automatic VoIP traffic detection method for ports	IC	4-281
switchport voice vlan security	Enables Voice VLAN security on ports	IC	4-281
switchport voice vlan priority	Sets the VoIP traffic priority for ports	IC	4-282
show voice vlan	Displays Voice VLAN settings	PE	4-283

### voice vlan

This command enables VoIP traffic detection and defines the Voice VLAN ID. Use the **no** form to disable the Voice VLAN.

#### Syntax

```
voice vlan voice-vlan-id  
no voice vlan
```

*voice-vlan-id* - Specifies the voice VLAN ID. (Range: 1-4094)

#### Default Setting

Disabled

#### Command Mode

Global Configuration

#### Command Usage

- When IP telephony is deployed in an enterprise network, it is recommended to isolate the Voice over IP (VoIP) network traffic from other data traffic. Traffic isolation helps prevent excessive packet delays, packet loss, and jitter, which results in higher voice quality. This is best achieved by assigning all VoIP traffic to a single VLAN.
- VoIP traffic can be detected on switch ports by using the source MAC address of packets, or by using LLDP (IEEE 802.1AB) to discover connected VoIP devices. When VoIP traffic is detected on a configured port, the switch automatically assigns the port as a tagged member of the Voice VLAN.
- Only one Voice VLAN is supported and it must already be created on the switch before it can be specified as the Voice VLAN.
- The Voice VLAN ID cannot be modified when the global auto-detection status is enabled (see the **switchport voice vlan** command on page 4-280).

#### Example

The following example enables VoIP traffic detection and specifies the Voice VLAN ID as 1234.

```
Console(config)#voice vlan 1234  
Console(config)#
```

### voice vlan aging

This command sets the Voice VLAN ID time out. Use the **no** form to restore the default.

#### Syntax

```
voice vlan aging minutes  
no voice vlan
```

*minutes* - Specifies the port Voice VLAN membership time out.  
(Range: 5-43200 minutes)



## Default Setting

1440 minutes

## Command Mode

Global Configuration

## Command Usage

The Voice VLAN aging time is the time after which a port is removed from the Voice VLAN when VoIP traffic is no longer received on the port.

## Example

The following example configures the Voice VLAN aging time as 3000 minutes.

```
Console(config)#voice vlan aging 3000
Console(config)#
```

## voice vlan mac-address

This command specifies MAC address ranges to add to the OUI Telephony list. Use the **no** form to remove an entry from the list.

## Syntax

**voice vlan mac-address** *mac-address mask mask-address*  
[**description** *description*]

**no voice vlan mac-address** *mac-address mask mask-address*

- *mac-address* - Defines a MAC address OUI that identifies VoIP devices in the network. (For example, 01-23-45-00-00-00)
- *mask-address* - Identifies a range of MAC addresses.  
(Range: 80-00-00-00-00-00 to FF-FF-FF-FF-FF-FF)
- *description* - User-defined text that identifies the VoIP devices.  
(Range: 1-32 characters)

## Default Setting

None

## Command Mode

Global Configuration

## Command Usage

- VoIP devices attached to the switch can be identified by the manufacturer's Organizational Unique Identifier (OUI) in the source MAC address of received packets. OUI numbers are assigned to manufacturers and form the first three octets of device MAC addresses. The MAC OUI numbers for VoIP equipment can be configured on the switch so that traffic from these devices is recognized as VoIP.

## 4 Command Line Interface

- Selecting a mask of FF-FF-FF-00-00-00 identifies all devices with the same OUI (the first three octets). Other masks restrict the MAC address range. Selecting FF-FF-FF-FF-FF-FF specifies a single MAC address.

### Example

The following example adds a MAC OUI to the OUI Telephony list.

```
Console(config)#voice vlan mac-address 00-12-34-56-78-90 mask
ff-ff-ff-00-00-00 description A new phone
Console(config)#
```

### switchport voice vlan

This command specifies the Voice VLAN mode for ports. Use the **no** form to disable the Voice VLAN feature on the port.

### Syntax

```
switchport voice vlan {manual | auto}
no switchport voice vlan
```

- **manual** - The Voice VLAN feature is enabled on the port, but the port must be manually added to the Voice VLAN.
- **auto** - The port will be added as a tagged member to the Voice VLAN when VoIP traffic is detected on the port.

### Default Setting

Disabled

### Command Mode

Interface Configuration

### Command Usage

When **auto** is selected, you must select the method to use for detecting VoIP traffic, either OUI or 802.1ab (LLDP) using the **switchport voice vlan rule** command (page 4-281). When OUI is selected, be sure to configure the MAC address ranges in the Telephony OUI list using the **voice vlan mac-address** command (page 4-279).

### Example

The following example sets port 1 to Voice VLAN auto mode.

```
Console(config)#interface ethernet 1/1
Console(config-if)#switchport voice vlan auto
Console(config-if)#
```

### switchport voice vlan rule

This command selects a method for detecting VoIP traffic on a port. Use the **no** form to disable the detection method on the port.

#### Syntax

[no] **switchport voice vlan rule** {oui | lldp}

- **oui** - Traffic from VoIP devices is detected by the Organizationally Unique Identifier (OUI) of the source MAC address.
- **lldp** - Uses LLDP to discover VoIP devices attached to the port.

#### Default Setting

OUI: Enabled  
LLDP: Disabled

#### Command Mode

Interface Configuration

#### Command Usage

- When OUI is selected, be sure to configure the MAC address ranges in the Telephony OUI list (see the **voice vlan mac-address** command on page 4-279). MAC address OUI numbers must be configured in the Telephony OUI list so that the switch recognizes the traffic as being from a VoIP device.
- LLDP checks that the “telephone bit” in the system capability TLV is turned on. See “Spanning Tree Commands” on page 4-225 for more information on LLDP.

#### Example

The following example enables the OUI method on port 1 for detecting VoIP traffic.

```
Console(config)#interface ethernet 1/1
Console(config-if)#switchport voice vlan rule oui
Console(config-if)#
```

### switchport voice vlan security

This command enables security filtering for VoIP traffic on a port. Use the **no** form to disable filtering on a port.

#### Syntax

[no] **switchport voice vlan security**

#### Default Setting

Disabled

#### Command Mode

Interface Configuration

### Command Usage

- Security filtering discards any non-VoIP packets received on the port that are tagged with the voice VLAN ID. VoIP traffic is identified by source MAC addresses configured in the Telephony OUI list, or through LLDP that discovers VoIP devices attached to the switch. Packets received from non-VoIP sources are dropped.
- When enabled, be sure the MAC address ranges for VoIP devices are configured in the Telephony OUI list (**voice vlan mac-address**, page 4-279).

### Example

The following example enables security filtering on port 1.

```
Console(config)#interface ethernet 1/1
Console(config-if)#switchport voice vlan security
Console(config-if)#
```

### switchport voice vlan priority

This command specifies a CoS priority for VoIP traffic on a port. Use the **no** form to restore the default priority on a port.

### Syntax

```
switchport voice vlan priority priority-value
no switchport voice vlan priority
```

- *priority-value* - The CoS priority value. (Range: 0-6)

### Default Setting

6

### Command Mode

Interface Configuration

### Command Usage

Specifies a CoS priority to apply to the port VoIP traffic on the Voice VLAN. The priority of any received VoIP packet is overwritten with the new priority when the Voice VLAN feature is active for the port.

### Example

The following example sets the CoS priority to 5 on port 1.

```
Console(config)#interface ethernet 1/1
Console(config-if)#switchport voice vlan priority 5
Console(config-if)#
```

## show voice vlan

This command displays the Voice VLAN settings on the switch and the OUI Telephony list.

### Syntax

**show voice vlan {oui | status}**

- **oui** - Displays the OUI Telephony list.
- **status** - Displays the global and port Voice VLAN settings.

### Default Setting

None

### Command Mode

Privileged Exec

### Example

```

Console#show voice vlan status
Global Voice VLAN Status
Voice VLAN Status      : Enabled
Voice VLAN ID          : 1234
Voice VLAN aging time  : 1440 minutes

Voice VLAN Port Summary
Port      Mode      Security Rule      Priority
-----
Eth 1/ 1  Auto      Enabled OUI                6
Eth 1/ 2  Disabled  Disabled OUI                6
Eth 1/ 3  Manual    Enabled OUI                5
Eth 1/ 4  Auto      Enabled OUI                6
Eth 1/ 5  Disabled  Disabled OUI                6
Eth 1/ 6  Disabled  Disabled OUI                6
Eth 1/ 7  Disabled  Disabled OUI                6
Eth 1/ 8  Disabled  Disabled OUI                6
Eth 1/ 9  Disabled  Disabled OUI                6
Eth 1/10  Disabled  Disabled OUI                6

Console#show voice vlan oui
OUIAddress      Mask      Description
00-12-34-56-78-9A FF-FF-FF-00-00-00 old phones
00-11-22-33-44-55 FF-FF-FF-00-00-00 new phones
00-98-76-54-32-10 FF-FF-FF-FF-FF-FF Chris' phone

Console#

```

## LLDP Commands

Link Layer Discovery Protocol (LLDP) is used to discover basic information about neighboring devices on the local broadcast domain. LLDP is a Layer 2 protocol that uses periodic broadcasts to advertise information about the sending device.

Advertised information is represented in Type Length Value (TLV) format according to the IEEE 802.1ab standard, and can include details such as device identification, capabilities and configuration settings. LLDP also defines how to store and maintain information gathered about the neighboring network nodes it discovers.

Link Layer Discovery Protocol - Media Endpoint Discovery (LLDP-MED) is an extension of LLDP intended for managing endpoint devices such as Voice over IP phones and network switches. The LLDP-MED TLVs advertise information such as network policy, power, inventory, and device location details. LLDP and LLDP-MED information can be used by SNMP applications to simplify troubleshooting, enhance network management, and maintain an accurate network topology.

**Table 4-79 LLDP Commands**

Command	Function	Mode	Page
lldp	Enables LLDP globally on the switch	GC	4-286
lldp holdtime-multiplier	Configures the time-to-live (TTL) value sent in LLDP advertisements	GC	4-286
medFastStartCount	Configures how many medFastStart packets are transmitted	GC	4-287
lldp notification-interval	Configures the allowed interval for sending SNMP notifications about LLDP changes	GC	4-287
lldp refresh-interval	Configures the periodic transmit interval for LLDP advertisements	GC	4-288
lldp reinit-delay	Configures the delay before attempting to re-initialize after LLDP ports are disabled or the link goes down	GC	4-288
lldp tx-delay	Configures a delay between the successive transmission of advertisements initiated by a change in local LLDP MIB variables	GC	4-289
lldp admin-status	Enables LLDP transmit, receive, or transmit and receive mode on the specified port	IC	4-290
lldp notification	Enables the transmission of SNMP trap notifications about LLDP changes	IC	4-290
lldp mednotification	Enables the transmission of SNMP trap notifications about LLDP-MED changes	IC	4-291
lldp basic-tlv management-ip-address	Configures an LLDP-enabled port to advertise the management address for this device	IC	4-292
lldp basic-tlv port-description	Configures an LLDP-enabled port to advertise its port description	IC	4-292
lldp basic-tlv system-capabilities	Configures an LLDP-enabled port to advertise its system capabilities	IC	4-293
lldp basic-tlv system-description	Configures an LLDP-enabled port to advertise the system description	IC	4-293

**Table 4-79 LLDP Commands** (Continued)

Command	Function	Mode	Page
lldp basic-tlv system-name	Configures an LLDP-enabled port to advertise its system name	IC	4-294
lldp dot1-tlv proto-ident*	Configures an LLDP-enabled port to advertise the supported protocols	IC	4-294
lldp dot1-tlv proto-vid*	Configures an LLDP-enabled port to advertise port related VLAN information	IC	4-295
lldp dot1-tlv pvid*	Configures an LLDP-enabled port to advertise its default VLAN ID	IC	4-295
lldp dot1-tlv vlan-name*	Configures an LLDP-enabled port to advertise its VLAN name	IC	4-296
lldp dot3-tlv link-agg	Configures an LLDP-enabled port to advertise its link aggregation capabilities	IC	4-296
lldp dot3-tlv mac-phy	Configures an LLDP-enabled port to advertise its MAC and physical layer specifications	IC	4-297
lldp dot3-tlv max-frame	Configures an LLDP-enabled port to advertise its maximum frame size	IC	4-297
lldp dot3-tlv poe	Configures an LLDP-enabled port to advertise its Power-over-Ethernet capabilities	IC	4-298
lldp medtlv extpoe	Configures an LLDP-MED-enabled port to advertise its extended Power over Ethernet configuration and usage information	IC	4-298
lldp medtlv inventory	Configures an LLDP-MED-enabled port to advertise its inventory identification details	IC	4-299
lldp medtlv location	Configures an LLDP-MED-enabled port to advertise its location identification details	IC	4-299
lldp medtlv med-cap	Configures an LLDP-MED-enabled port to advertise its Media Endpoint Device capabilities	IC	4-300
lldp medtlv network-policy	Configures an LLDP-MED-enabled port to advertise its network policy configuration	IC	4-300
show lldp config	Shows LLDP configuration settings for all ports	PE	4-301
show lldp info local-device	Shows LLDP global and interface-specific configuration settings for this device	PE	4-303
show lldp info remote-device	Shows LLDP global and interface-specific configuration settings for remote devices	PE	4-304
show lldp info statistics	Shows statistical counters for all LLDP-enabled interfaces	PE	4-305

\* Vendor-specific options may or may not be advertised by neighboring devices.

## 4 Command Line Interface

### lldp

This command enables LLDP globally on the switch. Use the **no** form to disable LLDP.

### Syntax

[no] lldp

### Default Setting

Enabled

### Command Mode

Global Configuration

### Example

```
Console(config)#lldp
Console(config)#
```

### lldp holdtime-multiplier

This command configures the time-to-live (TTL) value sent in LLDP advertisements. Use the **no** form to restore the default setting.

### Syntax

lldp holdtime-multiplier *value*  
no lldp holdtime-multiplier

*value* - Calculates the TTL in seconds based on  
(holdtime-multiplier \* refresh-interval) ≤ 65536  
(Range: 2 - 10)

### Default Setting

Holdtime multiplier: 4  
TTL: 4\*30 = 120 seconds

### Command Mode

Global Configuration

### Command Usage

The time-to-live tells the receiving LLDP agent how long to retain all information pertaining to the sending LLDP agent if it does not transmit updates in a timely manner.

### Example

```
Console(config)#lldp holdtime-multiplier 10
Console(config)#
```



### lldp medFastStartCount

This command specifies the amount of MED Fast Start LLDPDUs to transmit during the activation process of the LLDP-MED Fast Start mechanism.

#### Syntax

**lldp medfaststartcount** *packets*

*seconds* - Amount of packets. (Range: 1-10 packets; Default: 4 packets)

#### Default Setting

4 packets

#### Command Mode

Global Configuration

#### Command Usage

The MEDFastStartCount parameter is part of the timer which ensures that the LLDP-MED Fast Start mechanism is active for the port. LLDP-MED Fast Start is critical to the timely startup of LLDP, and therefore integral to the rapid availability of Emergency Call Service.

#### Example

```
Console(config)#lldp medfaststartcount 6
Console(config)#
```

### lldp notification-interval

This command configures the allowed interval for sending SNMP notifications about LLDP MIB changes. Use the **no** form to restore the default setting.

#### Syntax

**lldp notification-interval** *seconds*

**no lldp notification-interval**

*seconds* - Specifies the periodic interval at which SNMP notifications are sent. (Range: 5 - 3600 seconds)

#### Default Setting

5 seconds

#### Command Mode

Global Configuration

#### Command Usage

- This parameter only applies to SNMP applications which use data stored in the LLDP MIB for network monitoring or management.
- Information about changes in LLDP neighbors that occur between SNMP notifications is not transmitted. Only state changes that exist at the time of a

## 4 Command Line Interface

notification are included in the transmission. An SNMP agent should therefore periodically check the value of `IldpStatsRemTableLastChangeTime` to detect any `IldpRemTablesChange` notification-events missed due to throttling or transmission loss.

### Example

```
Console(config)#lldp notification-interval 30
Console(config)#
```

### Ildp refresh-interval

This command configures the periodic transmit interval for LLDP advertisements. Use the **no** form to restore the default setting.

### Syntax

**Ildp refresh-interval** *seconds*  
**no Ildp refresh-delay**

*seconds* - Specifies the periodic interval at which LLDP advertisements are sent. (Range: 5 - 32768 seconds)

### Default Setting

30 seconds

### Command Mode

Global Configuration

### Command Usage

This attribute must comply with the following rule:  
(refresh-interval \* holdtime-multiplier) ≤ 65536

### Example

```
Console(config)#lldp refresh-interval 60
Console(config)#
```

### Ildp reinit-delay

This command configures the delay before attempting to re-initialize after LLDP ports are disabled or the link goes down. Use the **no** form to restore the default setting.

### Syntax

**Ildp reinit-delay** *seconds*  
**no Ildp reinit-delay**

*seconds* - Specifies the delay before attempting to re-initialize LLDP. (Range: 1 - 10 seconds)

### Default Setting

2 seconds

## Command Mode

Global Configuration

## Command Usage

When LLDP is re-initialized on a port, all information in the remote systems LLDP MIB associated with this port is deleted.

## Example

```
Console(config)#lldp reinit-delay 10
Console(config)#
```

## lldp tx-delay

This command configures a delay between the successive transmission of advertisements initiated by a change in local LLDP MIB variables. Use the **no** form to restore the default setting.

## Syntax

**lldp tx-delay** *seconds*  
**no lldp tx-delay**

*seconds* - Specifies the transmit delay. (Range: 1 - 8192 seconds)

## Default Setting

2 seconds

## Command Mode

Global Configuration

## Command Usage

- The transmit delay is used to prevent a series of successive LLDP transmissions during a short period of rapid changes in local LLDP MIB objects, and to increase the probability that multiple, rather than single changes, are reported in each transmission.
- This attribute must comply with the following rule:  
 $(4 * \text{tx-delay}) \leq \text{refresh-interval}$

## Example

```
Console(config)#lldp tx-delay 10
Console(config)#
```

### lldp admin-status

This command enables LLDP transmit, receive, or transmit and receive mode on the specified port. Use the **no** form to disable this feature.

#### Syntax

```
lldp admin-status {rx-only | tx-only | tx-rx}  
no lldp admin-status
```

- **rx-only** - Only receive LLDP PDUs.
- **tx-only** - Only transmit LLDP PDUs.
- **tx-rx** - Both transmit and receive LLDP Protocol Data Units (PDUs).

#### Default Setting

tx-rx

#### Command Mode

Interface Configuration (Ethernet, Port Channel)

#### Example

```
Console(config)#interface ethernet 1/1  
Console(config-if)#lldp admin-status rx-only  
Console(config-if)#
```

### lldp notification

This command enables the transmission of SNMP trap notifications about LLDP changes. Use the **no** form to disable LLDP notifications.

#### Syntax

```
[no] lldp notification
```

#### Default Setting

Enabled

#### Command Mode

Interface Configuration (Ethernet, Port Channel)

#### Command Usage

- This option sends out SNMP trap notifications to designated target stations at the interval specified by the **lldp notification-interval** command (page 4-287). Trap notifications include information about state changes in the LLDP MIB (IEEE 802.1AB), or organization-specific LLDP-EXT-DOT1 and LLDP-EXT-DOT3 MIBs.
- SNMP trap destinations are defined using the **snmp-server host** command (page 4-90).
- Information about additional changes in LLDP neighbors that occur between SNMP notifications is not transmitted. Only state changes that exist at the time of a trap notification are included in the transmission. An SNMP agent should

therefore periodically check the value of `lldpStatsRemTableLastChangeTime` to detect any `lldpRemTablesChange` notification-events missed due to throttling or transmission loss.

### Example

```
Console(config)#interface ethernet 1/1
Console(config-if)#lldp notification
Console(config-if)#
```

### lldp mednotification

This command enables the transmission of SNMP trap notifications about LLDP-MED changes. Use the **no** form to disable LLDP-MED notifications.

### Syntax

[no] **lldp mednotification**

### Default Setting

Enabled

### Command Mode

Interface Configuration (Ethernet, Port Channel)

### Command Usage

- This option sends out SNMP trap notifications to designated target stations at the interval specified by the **lldp notification-interval** command (page 4-287). Trap notifications include information about state changes in the LLDP MIB (IEEE 802.1AB), the LLDP-MED MIB (ANSI/TIA 1057), or organization-specific LLDP-EXT-DOT1 and LLDP-EXT-DOT3 MIBs.
- SNMP trap destinations are defined using the **snmp-server host** command (page 4-90).
- Information about additional changes in LLDP neighbors that occur between SNMP notifications is not transmitted. Only state changes that exist at the time of a trap notification are included in the transmission. An SNMP agent should therefore periodically check the value of `lldpStatsRemTableLastChangeTime` to detect any `lldpRemTablesChange` notification-events missed due to throttling or transmission loss.

### Example

```
Console(config)#interface ethernet 1/1
Console(config-if)#lldp mednotification
Console(config-if)#
```

### lldp basic-tlv management-ip-address

This command configures an LLDP-enabled port to advertise the management address for this device. Use the **no** form to disable this feature.

#### Syntax

**[no] lldp basic-tlv management-ip-address**

#### Default Setting

Enabled

#### Command Mode

Interface Configuration (Ethernet, Port Channel)

#### Command Usage

- The management address protocol packet includes the IPv4 address of the switch. If no management address is available, the address should be the MAC address for the CPU or for the port sending this advertisement.
- The management address TLV may also include information about the specific interface associated with this address, and an object identifier indicating the type of hardware component or protocol entity associated with this address. The interface number and OID are included to assist SNMP applications to perform network discovery by indicating enterprise specific or other starting points for the search, such as the Interface or Entity MIB.
- Since there are typically a number of different addresses associated with a Layer 3 device, an individual LLDP PDU may contain more than one management address TLV.
- Every management address TLV that reports an address that is accessible on a port and protocol VLAN through the particular port should be accompanied by a port and protocol VLAN TLV that indicates the VLAN identifier (VID) associated with the management address reported by this TLV.

#### Example

```
Console(config)#interface ethernet 1/1
Console(config-if)#lldp basic-tlv management-ip-address
Console(config-if)#
```

### lldp basic-tlv port-description

This command configures an LLDP-enabled port to advertise its port description. Use the **no** form to disable this feature.

#### Syntax

**[no] lldp basic-tlv port-description**

#### Default Setting

Enabled

## Command Mode

Interface Configuration (Ethernet, Port Channel)

## Command Usage

The port description is taken from the ifDescr object in RFC 2863, which includes information about the manufacturer, the product name, and the version of the interface hardware/software.

## Example

```
Console(config)#interface ethernet 1/1
Console(config-if)#lldp basic-tlv port-description
Console(config-if)#
```

## lldp basic-tlv system-capabilities

This command configures an LLDP-enabled port to advertise its system capabilities. Use the **no** form to disable this feature.

## Syntax

[no] lldp basic-tlv system-capabilities

## Default Setting

Enabled

## Command Mode

Interface Configuration (Ethernet, Port Channel)

## Command Usage

The system capabilities identifies the primary function(s) of the system and whether or not these primary functions are enabled. The information advertised by this TLV is described in IEEE 802.1AB.

## Example

```
Console(config)#interface ethernet 1/1
Console(config-if)#lldp basic-tlv system-capabilities
Console(config-if)#
```

## lldp basic-tlv system-description

This command configures an LLDP-enabled port to advertise the system description. Use the **no** form to disable this feature.

## Syntax

[no] lldp basic-tlv system-description

## Default Setting

Enabled

## 4 Command Line Interface

### Command Mode

Interface Configuration (Ethernet, Port Channel)

### Command Usage

The system description is taken from the sysDescr object in RFC 3418, which includes the full name and version identification of the system's hardware type, software operating system, and networking software.

### Example

```
Console(config)#interface ethernet 1/1
Console(config-if)#lldp basic-tlv system-description
Console(config-if)#
```

### lldp basic-tlv system-name

This command configures an LLDP-enabled port to advertise the system name. Use the **no** form to disable this feature.

### Syntax

**[no] lldp basic-tlv system-name**

### Default Setting

Enabled

### Command Mode

Interface Configuration (Ethernet, Port Channel)

### Command Usage

The system name is taken from the sysName object in RFC 3418, which contains the system's administratively assigned name, and is in turn based on the **hostname** command (page 4-17).

### Example

```
Console(config)#interface ethernet 1/1
Console(config-if)#lldp basic-tlv system-name
Console(config-if)#
```

### lldp dot1-tlv proto-ident

This command configures an LLDP-enabled port to advertise the supported protocols. Use the **no** form to disable this feature.

### Syntax

**[no] lldp dot1-tlv proto-ident**

### Default Setting

Enabled



## Command Mode

Interface Configuration (Ethernet, Port Channel)

## Command Usage

This option advertises the protocols that are accessible through this interface.

## Example

```
Console(config)#interface ethernet 1/1
Console(config-if)#no lldp dot1-tlv proto-ident
Console(config-if)#
```

## Ildp dot1-tlv proto-vid

This command configures an LLDP-enabled port to advertise port related VLAN information. Use the **no** form to disable this feature.

## Syntax

[no] lldp dot1-tlv proto-vid

## Default Setting

Enabled

## Command Mode

Interface Configuration (Ethernet, Port Channel)

## Command Usage

This option advertises the port-based and protocol-based VLANs configured on this interface (see “Configuring VLAN Interfaces” on page 4-254 and “Configuring Protocol-based VLANs” on page 4-274).

## Example

```
Console(config)#interface ethernet 1/1
Console(config-if)#no lldp dot1-tlv proto-vid
Console(config-if)#
```

## Ildp dot1-tlv pvid

This command configures an LLDP-enabled port to advertise its default VLAN ID. Use the **no** form to disable this feature.

## Syntax

[no] lldp dot1-tlv pvid

## Default Setting

Enabled

## Command Mode

Interface Configuration (Ethernet, Port Channel)

### Command Usage

The port's default VLAN identifier (PVID) indicates the VLAN with which untagged or priority-tagged frames are associated (see “switchport native vlan” on page 4-257).

### Example

```
Console(config)#interface ethernet 1/1
Console(config-if)#no lldp dot1-tlv pvid
Console(config-if)#
```

### lldp dot1-tlv vlan-name

This command configures an LLDP-enabled port to advertise its VLAN name. Use the **no** form to disable this feature.

### Syntax

[no] lldp dot1-tlv vlan-name

### Default Setting

Enabled

### Command Mode

Interface Configuration (Ethernet, Port Channel)

### Command Usage

This option advertises the name of all VLANs to which this interface has been assigned. See “switchport allowed vlan” on page 4-258 and “protocol-vlan protocol-group (Configuring VLANs)” on page 4-275.

### Example

```
Console(config)#interface ethernet 1/1
Console(config-if)#no lldp dot1-tlv vlan-name
Console(config-if)#
```

### lldp dot3-tlv link-aggr

This command configures an LLDP-enabled port to advertise link aggregation capabilities. Use the **no** form to disable this feature.

### Syntax

[no] lldp dot3-tlv link-aggr

### Default Setting

Enabled

### Command Mode

Interface Configuration (Ethernet, Port Channel)

## Command Usage

This option advertises link aggregation capabilities, aggregation status of the link, and the 802.3 aggregated port identifier if this interface is currently a link aggregation member.

## Example

```
Console(config)#interface ethernet 1/1
Console(config-if)#no lldp dot3-tlv link-agg
Console(config-if)#
```

## Ildp dot3-tlv mac-phy

This command configures an LLDP-enabled port to advertise its MAC and physical layer capabilities. Use the **no** form to disable this feature.

## Syntax

[no] **lldp dot3-tlv mac-phy**

## Default Setting

Enabled

## Command Mode

Interface Configuration (Ethernet, Port Channel)

## Command Usage

This option advertises MAC/PHY configuration/status which includes information about auto-negotiation support/capabilities, and operational Multistation Access Unit (MAU) type.

## Example

```
Console(config)#interface ethernet 1/1
Console(config-if)#no lldp dot3-tlv mac-phy
Console(config-if)#
```

## Ildp dot3-tlv max-frame

This command configures an LLDP-enabled port to advertise its maximum frame size. Use the **no** form to disable this feature.

## Syntax

[no] **lldp dot3-tlv max-frame**

## Default Setting

Enabled

## Command Mode

Interface Configuration (Ethernet, Port Channel)

### Command Usage

Refer to “Frame Size Commands” on page 4-33 for information on configuring the maximum frame size for this switch.

### Example

```
Console(config)#interface ethernet 1/1
Console(config-if)#lldp dot3-tlv max-frame
Console(config-if)#
```

### lldp dot3-tlv poe

This command configures an LLDP-enabled port to advertise its Power-over-Ethernet (PoE) capabilities. Use the **no** form to disable this feature.

### Syntax

**[no] lldp dot3-tlv poe**

### Default Setting

Enabled

### Command Mode

Interface Configuration (Ethernet, Port Channel)

### Command Usage

This option advertises Power-over-Ethernet capabilities, including whether or not PoE is supported, currently enabled, if the port pins through which power is delivered can be controlled, the port pins selected to deliver power, and the power class.

### Example

```
Console(config)#interface ethernet 1/1
Console(config-if)#lldp dot3-tlv poe
Console(config-if)#
```

### lldp medtlv extpoe

This command configures an LLDP-MED-enabled port to advertise and accept Extended Power-over-Ethernet configuration and usage information. Use the **no** form to disable this feature.

### Syntax

**[no] lldp medtlv extpoe**

### Default Setting

Enabled

### Command Mode

Interface Configuration (Ethernet, Port Channel)

## Command Usage

This option advertises extended Power-over-Ethernet capability details, such as power availability from the switch, and power state of the switch, including whether the switch is operating from primary or backup power (the Endpoint Device could use this information to decide to enter power conservation mode).

## Example

```
Console(config)#interface ethernet 1/1
Console(config-if)#no lldp medtlv extpoe
Console(config-if)#
```

## lldp medtlv inventory

This command configures an LLDP-MED-enabled port to advertise its inventory identification details. Use the **no** form to disable this feature.

## Syntax

[no] **lldp medtlv inventory**

## Default Setting

Enabled

## Command Mode

Interface Configuration (Ethernet, Port Channel)

## Command Usage

This option advertises device details useful for inventory management, such as manufacturer, model, software version and other pertinent information.

## Example

```
Console(config)#interface ethernet 1/1
Console(config-if)#no lldp medtlv inventory
Console(config-if)#
```

## lldp medtlv location

This command configures an LLDP-MED-enabled port to advertise its location identification details. Use the **no** form to disable this feature.

## Syntax

[no] **lldp medtlv location**

## Default Setting

Enabled

## Command Mode

Interface Configuration (Ethernet, Port Channel)

## 4 Command Line Interface

### Command Usage

This option advertises location identification details.

### Example

```
Console(config)#interface ethernet 1/1
Console(config-if)#lldp medtlv location
Console(config-if)#
```

### Ildp medtlv med-cap

This command configures an LLDP-MED-enabled port to advertise its Media Endpoint Device capabilities. Use the **no** form to disable this feature.

### Syntax

[no] **lldp medtlv med-cap**

### Default Setting

Enabled

### Command Mode

Interface Configuration (Ethernet, Port Channel)

### Command Usage

This option advertises LLDP-MED TLV capabilities, allowing Media Endpoint and Connectivity Devices to efficiently discover which LLDP-MED related TLVs are supported on the switch.

### Example

```
Console(config)#interface ethernet 1/1
Console(config-if)#lldp medtlv med-cap
Console(config-if)#
```

### Ildp medtlv network-policy

This command configures an LLDP-MED-enabled port to advertise its network policy configuration. Use the **no** form to disable this feature.

### Syntax

[no] **lldp medtlv network-policy**

### Default Setting

Enabled

### Command Mode

Interface Configuration (Ethernet, Port Channel)

## Command Usage

This option advertises network policy configuration information, aiding in the discovery and diagnosis of VLAN configuration mismatches on a port. Improper network policy configurations frequently result in voice quality degradation or complete service disruption.

## Example

```
Console(config)#interface ethernet 1/1
Console(config-if)#lldp medtlv network-policy
Console(config-if)#
```

## show lldp config

This command shows LLDP configuration settings for all ports.

## Syntax

**show lldp config** [**detail** *interface*]

- **detail** - Shows configuration summary.
- *interface*
  - **ethernet** *unit/port*
    - *unit* - Stack unit. (Range: 1)
    - *port* - Port number. (Range: 1-28)
  - **port-channel** *channel-id* (Range: 1-8)

## Command Mode

Privileged Exec

## Example

```
Console#show lldp config

LLDP Global Configuration

LLDP Enable           : Yes
LLDP Transmit interval : 30
LLDP Hold Time Multiplier : 4
LLDP Delay Interval   : 2
LLDP Reinit Delay     : 2
LLDP Notification Interval : 5
LLDP MED fast start counts : 4

LLDP Port Configuration

Interface |AdminStatus NotificationEnabled
-----+-----
Eth 1/1  |Tx-Rx      True
Eth 1/2  |Tx-Rx      True
Eth 1/3  |Tx-Rx      True
Eth 1/4  |Tx-Rx      True
Eth 1/5  |Tx-Rx      True
:
:
Console#show lldp config detail ethernet 1/1

LLDP Port Configuration Detail

Port : Eth 1/1
Admin Status : Tx-Rx
Notification Enabled : True
Basic TLVs Advertised:
  port-description
  system-name
  system-description
  system-capabilities
  management-ip-address
802.1 specific TLVs Advertised:
  *port-vid
  *vlan-name
  *proto-vlan
  *proto-ident
802.3 specific TLVs Advertised:
  *mac-phy
  *poe
  *link-agg
  *max-frame
MED Configuration:
MED Notification Enabled : True MED Enabled TLVs Advertised:
  *med-cap
  *network-policy
  *location
  *extPoe
  *inventory

Console#
```



## show lldp info local-device

This command shows LLDP global and interface-specific configuration settings for this device.

### Syntax

**show lldp info local-device [detail *interface*]**

- **detail** - Shows detailed information.
- **interface**
  - **ethernet *unit/port***
    - *unit* - Stack unit. (Range: 1)
    - *port* - Port number. (Range: 1-28)
  - **port-channel *channel-id*** (Range: 1-8)

### Command Mode

Privileged Exec

### Example

```

Console#show lldp info local-device

LLDP Local System Information
Chassis Type : MAC Address
Chassis ID   : 00-01-02-03-04-05
System Name  :
System Description : 24 10/100 ports and 4 gigabit ports with PoE switch
System Capabilities Support : Bridge
System Capabilities Enable : Bridge
Management Address : 192.168.0.101 (IPv4)

LLDP Port Information
Interface | PortID Type      PortID      PortDesc
-----+-----
Eth 1/1  | MAC Address     00-01-02-03-04-06 Ethernet Port on unit 1, port 1
Eth 1/2  | MAC Address     00-01-02-03-04-07 Ethernet Port on unit 1, port 2
Eth 1/3  | MAC Address     00-01-02-03-04-08 Ethernet Port on unit 1, port 3
Eth 1/4  | MAC Address     00-01-02-03-04-09 Ethernet Port on unit 1, port 4
:
:
Console#show lldp info local-device detail ethernet 1/1

LLDP Port Information Detail

Port      : Eth 1/1
Port Type : MAC Address
Port ID   : 00-01-02-03-04-06
Port Desc : Ethernet Port on unit 1, port 1

Console#

```

## show lldp info remote-device

This command shows LLDP global and interface-specific configuration settings for remote devices attached to an LLDP-enabled port.

### Syntax

**show lldp info remote-device [detail interface]**

- **detail** - Shows detailed information.
- **interface**
  - **ethernet unit/port**
    - *unit* - Stack unit. (Range: 1)
    - *port* - Port number. (Range: 1-28)
  - **port-channel channel-id** (Range: 1-8)

### Command Mode

Privileged Exec

### Example

```
Console#show lldp info remote-device

LLDP Remote Devices Information

  Interface | ChassisId           PortId           SysName
  ----- + -----
  Eth 1/1   | 00-01-02-03-04-05  00-01-02-03-04-06

Console#show lldp info remote-device detail ethernet 1/1

LLDP Remote Devices Information Detail

-----
Local PortName      : Eth 1/1
Chassis Type        : MAC Address
Chassis Id          : 00-01-02-03-04-05
PortID Type         : MAC Address
PortID              : 00-01-02-03-04-06
SysName             :
SysDescr            : 24 10/100 ports and 4 gigabit ports with PoE switch
PortDescr           : Ethernet Port on unit 1, port 1
SystemCapSupported  : Bridge
SystemCapEnabled    : Bridge
Remote Management Address :
    00-01-02-03-04-05 (MAC Address)

Console#
```

## show lldp info statistics

This command shows statistics based on traffic received through all attached LLDP-enabled interfaces.

### Syntax

**show lldp info statistics** [**detail** *interface*]

- **detail** - Shows detailed information.
- *interface*
  - **ethernet** *unit/port*
    - *unit* - Stack unit. (Range: 1)
    - *port* - Port number. (Range: 1-28)
  - **port-channel** *channel-id* (Range: 1-8)

### Command Mode

Privileged Exec

### Example

```
switch#show lldp info statistics

LLDP Device Statistics

Neighbor Entries List Last Updated : 2450279 seconds
New Neighbor Entries Count         : 1
Neighbor Entries Deleted Count     : 0
Neighbor Entries Dropped Count     : 0
Neighbor Entries Ageout Count      : 0

Interface | NumFramesRecvd NumFramesSent NumFramesDiscarded
-----+-----+-----+-----
Eth 1/1   | 10             11             0
Eth 1/2   | 0              0              0
Eth 1/3   | 0              0              0
Eth 1/4   | 0              0              0
Eth 1/5   | 0              0              0
:
:
switch#show lldp info statistics detail ethernet 1/1

LLDP Port Statistics Detail

PortName       : Eth 1/1
Frames Discarded : 0
Frames Invalid  : 0
Frames Received : 12
Frames Sent     : 13
TLVs Unrecognized : 0
TLVs Discarded  : 0
Neighbor Ageouts : 0

switch#
```

## Class of Service Commands

The commands described in this section allow you to specify which data packets have greater precedence when traffic is buffered in the switch due to congestion. This switch supports CoS with four priority queues for each port. Data packets in a port's high-priority queue will be transmitted before those in the lower-priority queues. You can set the default priority for each interface, the relative weight of each queue, and the mapping of frame priority tags to the switch's priority queues.

**Table 4-80 Priority Commands**

Command Groups	Function	Page
Priority (Layer 2)	Configures default priority for untagged frames, sets queue weights, and maps class of service tags to hardware queues	4-306
Priority (Layer 3 and 4)	Maps IP DSCP tags to class of service values	4-311

## Priority Commands (Layer 2)

**Table 4-81 Priority Commands (Layer 2)**

Command	Function	Mode	Page
queue mode	Sets the queue mode to strict priority or Weighted Round-Robin (WRR)	GC	4-306
switchport priority default	Sets a port priority for incoming untagged frames	IC	4-307
queue cos map	Assigns class-of-service values to the priority queues	IC	4-308
show queue mode	Shows the current queue mode	PE	4-309
show queue bandwidth	Shows round-robin weights assigned to the priority queues	PE	4-309
show queue cos-map	Shows the class-of-service map	PE	4-310
show interfaces switchport	Displays the administrative and operational status of an interface	PE	4-199

### queue mode

This command sets the queue mode to strict priority or Weighted Round-Robin (WRR) for the class of service (CoS) priority queues. Use the **no** form to restore the default value.

### Syntax

```
queue mode {strict | wrr}
no queue mode
```

- **strict** - Services the egress queues in sequential order, transmitting all traffic in the higher priority queues before servicing lower priority queues.
- **wrr** - Weighted Round-Robin shares bandwidth at the egress ports by using scheduling weights 1, 2, 4, 8 for queues 0 - 3 respectively.

### Default Setting

Weighted Round Robin

## Command Mode

Global Configuration

## Command Usage

- Strict priority requires all traffic in a higher priority queue to be processed before lower priority queues are serviced.
- WRR uses a relative weight for each queue which determines the number of packets the switch transmits every time it services a queue before moving on to the next queue. Thus, a queue weighted 8 will be allowed to transmit up to 8 packets, after which the next lower priority queue will be serviced according to its weighting. This prevents the head-of-line blocking that can occur with strict priority queuing.

## Example

The following example sets the queue mode to strict priority service mode:

```
Console(config)#queue mode strict
Console(config)#
```

## switchport priority default

This command sets a priority for incoming untagged frames. Use the **no** form to restore the default value.

## Syntax

**switchport priority default** *default-priority-id*  
**no switchport priority default**

*default-priority-id* - The priority number for untagged ingress traffic.  
The priority is a number from 0 to 7. Seven is the highest priority.

## Default Setting

The priority is not set, and the default value for untagged frames received on the interface is zero.

## Command Mode

Interface Configuration (Ethernet, Port Channel)

## Command Usage

- The precedence for priority mapping is IP DSCP, and default switchport priority.
- The default priority applies for an untagged frame received on a port set to accept all frame types (i.e., receives both untagged and tagged frames). This priority does not apply to IEEE 802.1Q VLAN tagged frames. If the incoming frame is an IEEE 802.1Q VLAN tagged frame, the IEEE 802.1p User Priority bits will be used.

## 4 Command Line Interface

- This switch provides eight priority queues for each port. It is configured to use Weighted Round Robin, which can be viewed with the **show queue bandwidth** command. Inbound frames that do not have VLAN tags are tagged with the input port's default ingress user priority, and then placed in the appropriate priority queue at the output port. The default priority for all ingress ports is zero. Therefore, any inbound frames that do not have priority tags will be placed in queue 0 of the output port. (Note that if the output port is an untagged member of the associated VLAN, these frames are stripped of all VLAN tags prior to transmission.)

### Example

The following example shows how to set a default priority on port 3 to 5:

```
Console(config)#interface ethernet 1/3
Console(config-if)#switchport priority default 5
Console(config-if)#
```

### Related Commands

show interfaces switchport (4-199)

### queue cos-map

This command assigns class of service (CoS) values to the priority queues (i.e., hardware output queues 0 - 3). Use the **no** form set the CoS map to the default values.

### Syntax

```
queue cos-map queue_id [cos1 ... cosn]
no queue cos-map
```

- *queue\_id* - The ID of the priority queue.  
Ranges are 0 to 3, where 3 is the highest priority queue.
- *cos1* .. *cosn* - The CoS values that are mapped to the queue ID. It is a space-separated list of numbers. The CoS value is a number from 0 to 7, where 7 is the highest priority.

### Default Setting

This switch supports Class of Service by using four priority queues, with Weighted Round Robin queuing for each port. Eight separate traffic classes are defined in IEEE 802.1p. The default priority levels are assigned according to recommendations in the IEEE 802.1p standard as shown below.

Table 4-82 Default CoS Values to Egress Queues

Queue	0	1	2	3
Priority	1,2	0,3	4,5	6,7

### Command Mode

Interface Configuration (Ethernet, Port Channel)

## Command Usage

- CoS values assigned at the ingress port are also used at the egress port.
- This command sets the CoS priority for all interfaces.

## Example

The following example shows how to change the CoS assignments:

```
Console(config)#interface ethernet 1/1
Console(config-if)#queue cos-map 0 0
Console(config-if)#queue cos-map 1 1
Console(config-if)#queue cos-map 2 2
Console(config-if)#exit
Console#show queue cos-map ethernet 1/1
Information of Eth 1/1
  Traffic Class : 0 1 2 3 4 5 6 7
  Priority Queue: 0 1 2 1 2 2 3 3
Console#
```

## Related Commands

show queue cos-map (4-310)

## show queue mode

This command shows the current queue mode.

## Default Setting

None

## Command Mode

Privileged Exec

## Example

```
Console#show queue mode
Queue mode: wrr
Console#
```

## show queue bandwidth

This command displays the weighted round-robin (WRR) bandwidth allocation for the four priority queues.

## Default Setting

None

## Command Mode

Privileged Exec

## 4 Command Line Interface

### Example

```
Console#show queue bandwidth
Queue ID  Weight
-----  -
0         1
1         2
2         4
3         8
Console#
```

### show queue cos-map

This command shows the class of service priority map.

### Syntax

**show queue cos-map** [*interface*]

*interface*

- **ethernet** *unit/port*
  - *unit* - Stack unit. (Range: 1)
  - *port* - Port number. (Range: 1-28)
- **port-channel** *channel-id* (Range: 1-8)

### Default Setting

None

### Command Mode

Privileged Exec

### Example

```
Console#show queue cos-map ethernet 1/1
Information of Eth 1/1
Traffic Class : 0 1 2 3 4 5 6 7
Priority Queue: 1 0 0 1 2 2 3 3
Console#
```



## Priority Commands (Layer 3 and 4)

This section describes commands used to configure Layer 3 and Layer 4 traffic priority on the switch.

**Table 4-83 Priority Commands (Layer 3 and 4)**

Command	Function	Mode	Page
map ip dscp	Enables IP DSCP class of service mapping	GC	4-311
map ip dscp	Maps IP DSCP value to a class of service	IC	4-311
show map ip dscp	Shows the IP DSCP map	PE	4-312

### map ip dscp (Global Configuration)

This command enables IP DSCP mapping (i.e., Differentiated Services Code Point mapping). Use the **no** form to disable IP DSCP mapping.

#### Syntax

[no] map ip dscp

#### Default Setting

Disabled

#### Command Mode

Global Configuration

#### Command Usage

The precedence for priority mapping is IP DSCP and default switchport priority.

#### Example

The following example shows how to enable IP DSCP mapping globally:

```
Console(config)#map ip dscp
Console(config)#
```

### map ip dscp (Interface Configuration)

This command sets IP DSCP priority (i.e., Differentiated Services Code Point priority). Use the **no** form to restore the default table.

#### Syntax

map ip dscp *dscp-value* **cos** *cos-value*  
 no map ip dscp

- *dscp-value* - 8-bit DSCP value. (Range: 0-63)
- *cos-value* - Class-of-Service value (Range: 0-7)

## Default Setting

The DSCP default values are defined in the following table. Note that all the DSCP values that are not specified are mapped to CoS value 0.

**Table 4-84 IP DSCP to CoS Values**

IP DSCP Value	CoS Value
0	0
8	1
10, 12, 14, 16	2
18, 20, 22, 24	3
26, 28, 30, 32, 34, 36	4
38, 40, 42	5
48	6
46, 56	7

## Command Mode

Interface Configuration (Ethernet, Port Channel)

## Command Usage

- The precedence for priority mapping is IP DSCP and default switchport priority.
- DSCP priority values are mapped to default Class of Service values according to recommendations in the IEEE 802.1p standard, and then subsequently mapped to the four hardware priority queues.
- This command sets the IP DSCP priority for all interfaces.

## Example

The following example shows how to map IP DSCP value 1 to CoS value 0:

```
Console(config)#interface ethernet 1/5
Console(config-if)#map ip dscp 1 cos 0
Console(config-if)#
```

## show map ip dscp

This command shows the IP DSCP priority map.

## Syntax

**show map ip dscp** [*interface*]

*interface*

- **ethernet** *unit/port*
  - *unit* - Stack unit. (Range: 1)
  - *port* - Port number. (Range: 1-28)
- **port-channel** *channel-id* (Range: 1-8)

## Default Setting

None

## Command Mode

Privileged Exec

## Example

```

Console#show map ip dscp ethernet 1/1
DSCP mapping status: disabled

  Port          DSCP COS
  -----
  Eth 1/ 1     0   0
  Eth 1/ 1     1   0
  Eth 1/ 1     2   0
  Eth 1/ 1     3   0
  :
  Eth 1/ 1    61   0
  Eth 1/ 1    62   0
  Eth 1/ 1    63   0
Console#

```

## Related Commands

map ip dscp (Global Configuration) (4-311)

map ip dscp (Interface Configuration) (4-311)

# Quality of Service Commands

The commands described in this section are used to configure Differentiated Services (DiffServ) classification criteria and service policies. You can classify traffic based on access lists, IP Precedence or DSCP values, or VLANs. Using access lists allows you select traffic based on Layer 2, Layer 3, or Layer 4 information contained in each packet.

Table 4-85 Quality of Service Commands

Command	Function	Mode	Page
class-map	Creates a class map for a type of traffic	GC	4-314
match	Defines the criteria used to classify traffic	CM	4-315
policy-map	Creates a policy map for multiple interfaces	GC	4-316
class	Defines a traffic classification for the policy to act on	PM	4-317
set	Classifies IP traffic by setting a CoS or DSCP value in a packet	PM-C	4-318
police	Defines an enforcer for classified traffic	PM-C	4-319
service-policy	Applies a policy map defined by the <b>policy-map</b> command to the input of a particular interface	IC	4-320
show class-map	Displays the QoS class maps which define matching criteria used for classifying traffic	PE	4-320

**Table 4-85 Quality of Service Commands** (Continued)

Command	Function	Mode	Page
show policy-map	Displays the QoS policy maps which define classification criteria for incoming traffic, and may include policers for bandwidth limitations	PE	4-321
show policy-map interface	Displays the configuration of all classes configured for all service policies on the specified interface	PE	4-321

To create a service policy for a specific category of ingress traffic, follow these steps:

1. Use the **class-map** command to designate a class name for a specific category of traffic, and enter the Class Map configuration mode.
2. Use the **match** command to select a specific type of traffic based on an access list, a DSCP or IP Precedence value, or a VLAN.
3. Use the **policy-map** command to designate a policy name for a specific manner in which ingress traffic will be handled, and enter the Policy Map configuration mode.
4. Use the **class** command to identify the class map, and enter Policy Map Class configuration mode. A policy map can contain multiple class statements.
5. Use the **set** command to modify the QoS value for matching traffic class, and use the **policer** command to monitor the average flow and burst rate, and drop any traffic that exceeds the specified rate, or just reduce the DSCP service level for traffic exceeding the specified rate.
6. Use the **service-policy** command to assign a policy map to a specific interface.

- Notes:**
1. You can configure up to 16 rules per Class Map. You can also include multiple classes in a Policy Map.
  2. You should create a Class Map (page 4-314) before creating a Policy Map (page 4-316). Otherwise, you will not be able to specify a Class Map with the **class** command (page 4-317) after entering Policy-Map Configuration mode.

## class-map

This command creates a class map used for matching packets to the specified class, and enters Class Map configuration mode. Use the **no** form to delete a class map and return to Global configuration mode.

### Syntax

[no] **class-map** *class-map-name* [**match-any**]

- **match-any** - Match any condition within a class map.
- *class-map-name* - Name of the class map. (Range: 1-16 characters)

### Default Setting

None

### Command Mode

Global Configuration

## Command Usage

- First enter this command to designate a class map and enter the Class Map configuration mode. Then use the **match** command (page 4-315) to specify the criteria for ingress traffic that will be classified under this class map.
- Up to 16 **match** commands are permitted per class map.
- The class map is used with a policy map (page 4-316) to create a service policy (page 4-320) for a specific interface that defines packet classification, service tagging, and bandwidth policing.

## Example

This example creates a class map call "rd\_class," and sets it to match packets marked for DSCP service value 3:

```
Console(config)#class-map rd_class match-any
Console(config-cmap)#match ip dscp 3
Console(config-cmap)#
```

## Related Commands

show class map (4-320)

## match

This command defines the criteria used to classify traffic. Use the **no** form to delete the matching criteria.

## Syntax

```
[no] match {access-list acl-name | ip dscp dscp |
ip precedence ip-precedence | vlan vlan}
```

- *acl-name* - Name of the access control list. Any type of ACL can be specified, including standard or extended IP ACLs and MAC ACLs. (Range: 1-16 characters)
- *dscp* - A DSCP value. (Range: 0-63)
- *ip-precedence* - An IP Precedence value. (Range: 0-7)
- *vlan* - A VLAN. (Range:1-4094)

## Default Setting

None

## Command Mode

Class Map Configuration

## Command Usage

- First enter the **class-map** command to designate a class map and enter the Class Map configuration mode. Then use the **match** command to specify the fields within ingress packets that must match to qualify for this class map.
- Only one **match** command can be entered per class map.

## 4 Command Line Interface

### Example

This example creates a class map called “rd\_class#1,” and sets it to match packets marked for DSCP service value 3:

```
Console(config)#class-map rd_class#1_ match-any
Console(config-cmap)#match ip dscp 3
Console(config-cmap)#
```

This example creates a class map call “rd\_class#2,” and sets it to match packets marked for IP Precedence service value 5:

```
Console(config)#class-map rd_class#2 match-any
Console(config-cmap)#match ip precedence 5
Console(config-cmap)#
```

This example creates a class map call “rd\_class#3,” and sets it to match packets marked for VLAN 1:

```
Console(config)#class-map rd_class#3 match-any
Console(config-cmap)#match vlan 1
Console(config-cmap)#
```

### policy-map

This command creates a policy map that can be attached to multiple interfaces, and enters Policy Map configuration mode. Use the **no** form to delete a policy map and return to Global configuration mode.

#### Syntax

**[no] policy-map** *policy-map-name*

*policy-map-name* - Name of the policy map. (Range: 1-16 characters)

#### Default Setting

None

#### Command Mode

Global Configuration

#### Command Usage

- Use the **policy-map** command to specify the name of the policy map, and then use the **class** command to configure policies for traffic that matches criteria defined in a class map.
- A policy map can contain multiple class statements that can be applied to the same interface with the **service-policy** command (page 4-320).
- You must create a Class Map (page 4-316) before assigning it to a Policy Map.

## Example

This example creates a policy called “rd\_policy,” uses the **class** command to specify the previously defined “rd\_class,” uses the **set** command to classify the service that incoming packets will receive, and then uses the **police** command to limit the average bandwidth to 100,000 Kbps, the burst rate to 1522 bytes, and configure the response to drop any violating packets.

```
Console(config)#policy-map rd_policy
Console(config-pmap)#class rd_class
Console(config-pmap-c)#set ip dscp 3
Console(config-pmap-c)#police 100000 1522 exceed-action drop
Console(config-pmap-c)#
```

## class

This command defines a traffic classification upon which a policy can act, and enters Policy Map Class configuration mode. Use the **no** form to delete a class map and return to Policy Map configuration mode.

### Syntax

**[no] class** *class-map-name*

*class-map-name* - Name of the class map. (Range: 1-16 characters)

### Default Setting

None

### Command Mode

Policy Map Configuration

### Command Usage

- Use the **policy-map** command to specify a policy map and enter Policy Map configuration mode. Then use the **class** command to enter Policy Map Class configuration mode. And finally, use the **set** and **police** commands to specify the match criteria, where the:
  - **set** command classifies the service that an IP packet will receive.
  - **police** command defines the maximum throughput, burst rate, and the action that results from a policy violation.
- You can configure up to 16 rules per Class Map. You can also include multiple classes in a Policy Map.

### Example

This example creates a policy called “rd\_policy,” uses the **class** command to specify the previously defined “rd\_class,” uses the **set** command to classify the service that incoming packets will receive, and then uses the **police** command to limit the average bandwidth to 100,000 Kbps, the burst rate to 1522 bytes, and configure the response to drop any violating packets.

```
Console(config)#policy-map rd_policy
Console(config-pmap)#class rd_class
Console(config-pmap-c)#set ip dscp 3
Console(config-pmap-c)#police 100000 1522 exceed-action drop
Console(config-pmap-c)#
```

### set

This command services IP traffic by setting a CoS or DSCP, value in a matching packet (as specified by the **match** command on page 4-315). Use the **no** form to remove the traffic classification.

### Syntax

**[no] set {cos *new-cos* | ip dscp *new-dscp*}**

- *new-cos* - New Class of Service (CoS) value. (Range: 0-7)
- *new-dscp* - New Differentiated Service Code Point (DSCP) value. (Range: 0-63)

### Default Setting

None

### Command Mode

Policy Map Class Configuration

### Example

This example creates a policy called “rd\_policy,” uses the **class** command to specify the previously defined “rd\_class,” uses the **set** command to classify the service that incoming packets will receive, and then uses the **police** command to limit the average bandwidth to 100,000 Kbps, the burst rate to 1522 bytes, and configure the response to drop any violating packets.

```
Console(config)#policy-map rd_policy
Console(config-pmap)#class rd_class
Console(config-pmap-c)#set ip dscp 3
Console(config-pmap-c)#police 100000 1522 exceed-action drop
Console(config-pmap-c)#
```



## police

This command defines an policer for classified traffic. Use the **no** form to remove a policer.

### Syntax

**[no] police rate-kbps burst-byte [exceed-action {drop | set}]**

- *rate-kbps* - Rate in kilobits per second. (Range: 1-100000 kbps or maximum port speed, whichever is lower)
- *burst-byte* - Burst in bytes. (Range: 64-1522 bytes)
- **drop** - Drop packet when specified rate or burst are exceeded.
- **set** - Set DSCP service to the specified value. (Range: 0-63)

### Default Setting

Drop out-of-profile packets.

### Command Mode

Policy Map Class Configuration

### Command Usage

- You can configure up to 64 policers (i.e., meters or class maps) for each of the following access list types: MAC ACL, IP ACL (including Standard ACL and Extended ACL).
- Policing is based on a token bucket, where bucket depth (i.e., the maximum burst before the bucket overflows) is specified by the *burst-byte* field, and the average rate at which tokens are removed from the bucket is specified by the *rate-bps* option.

### Example

This example creates a policy called "rd\_policy," uses the **class** command to specify the previously defined "rd\_class," uses the **set** command to classify the service that incoming packets will receive, and then uses the **police** command to limit the average bandwidth to 100,000 Kbps, the burst rate to 1522 bytes, and configure the response to drop any violating packets.

```
Console(config)#policy-map rd_policy
Console(config-pmap)#class rd_class
Console(config-pmap-c)#set ip dscp 3
Console(config-pmap-c)#police 100000 1522 exceed-action drop
Console(config-pmap-c)#
```

## 4 Command Line Interface

### service-policy

This command applies a policy map defined by the **policy-map** command to the ingress queue of a particular interface. Use the **no** form to remove the policy map from this interface.

### Syntax

**[no] service-policy input *policy-map-name***

- **input** - Apply to the input traffic.
- *policy-map-name* - Name of the policy map for this interface.  
(Range: 1-16 characters)

### Default Setting

No policy map is attached to an interface.

### Command Mode

Interface Configuration (Ethernet, Port Channel)

### Command Usage

- You can only assign one policy map to an interface.
- You must first define a class map, then define a policy map, and finally use the **service-policy** command to bind the policy map to the required interface.

### Example

This example applies a service policy to an ingress interface.

```
Console(config)#interface ethernet 1/1
Console(config-if)#service-policy input rd_policy
Console(config-if)#
```

### show class-map

This command displays the QoS class maps which define matching criteria used for classifying traffic.

### Syntax

**show class-map [*class-map-name*]**

*class-map-name* - Name of the class map. (Range: 1-16 characters)

### Default Setting

Displays all class maps.

### Command Mode

Privileged Exec

## Example

```
Console#show class-map
Class Map match-any rd_class#1
  Match ip dscp 3

Class Map match-any rd_class#2
  Match ip precedence 5

Class Map match-any rd_class#3
  Match vlan 1

Console#
```

## show policy-map

This command displays the QoS policy maps which define classification criteria for incoming traffic, and may include policers for bandwidth limitations.

### Syntax

**show policy-map** [*policy-map-name* [**class** *class-map-name*]]

- *policy-map-name* - Name of the policy map. (Range: 1-16 characters)
- *class-map-name* - Name of the class map. (Range: 1-16 characters)

### Default Setting

Displays all policy maps and all classes.

### Command Mode

Privileged Exec

## Example

```
Console#show policy-map
Policy Map rd_policy
  class rd_class
    set ip dscp 3
Console#show policy-map rd_policy class rd_class
Policy Map rd_policy
  class rd_class
    set ip dscp 3
Console#
```

## show policy-map interface

This command displays the service policy assigned to the specified interface.

### Syntax

**show policy-map interface** *interface* **input**

*interface*

- **ethernet** *unit/port*
  - *unit* - Stack unit. (Range: 1)
  - *port* - Port number. (Range: 1-28)
- **port-channel** *channel-id* (Range: 1-8)

## Command Mode

Privileged Exec

### Example

```
Console#show policy-map interface ethernet 1/5
Service-policy rd_policy input
Console#
```

## Multicast Filtering Commands

This switch uses IGMP (Internet Group Management Protocol) to query for any attached hosts that want to receive a specific multicast service. It identifies the ports containing hosts requesting a service and sends data out to those ports only. It then propagates the service request up to any neighboring multicast switch/router to ensure that it will continue to receive the multicast service.

**Table 4-86 Multicast Filtering Commands**

Command Groups	Function	Page
IGMP Snooping	Configures multicast groups via IGMP snooping or static assignment, sets the IGMP version, displays current snooping and query settings, and displays the multicast service and group members	4-322
IGMP Query	Configures IGMP query parameters for multicast filtering at Layer 2	4-327
Static Multicast Routing	Configures static multicast router ports	4-330
IGMP Filtering and Throttling	Configures IGMP filtering and throttling	4-332
Multicast VLAN Registration	Configures a single network-wide multicast VLAN shared by hosts residing in other standard or private VLAN groups, preserving security and data isolation for normal traffic	4-339

## IGMP Snooping Commands

This section describes commands used to configure IGMP snooping on the switch.

**Table 4-87 IGMP Snooping Commands**

Command	Function	Mode	Page
ip igmp snooping	Enables IGMP snooping	GC	4-323
ip igmp snooping vlan static	Adds an interface as a member of a multicast group	GC	4-323
ip igmp snooping version	Configures the IGMP version for snooping	GC	4-324
ip igmp snooping leave-proxy	Enables IGMP leave proxy on the switch	GC	4-324
ip igmp snooping immediate-leave	Enables IGMP immediate leave for a VLAN interface	IC	4-325
show ip igmp snooping	Shows the IGMP snooping and query configuration	PE	4-324
show mac-address-table multicast	Shows the IGMP snooping MAC multicast list	PE	4-326

## ip igmp snooping

This command enables IGMP snooping on this switch. Use the **no** form to disable it.

### Syntax

```
[no] ip igmp snooping
```

### Default Setting

Enabled

### Command Mode

Global Configuration

### Example

The following example enables IGMP snooping.

```
Console(config)#ip igmp snooping
Console(config)#
```

## ip igmp snooping vlan static

This command adds a port to a multicast group. Use the **no** form to remove the port.

### Syntax

```
[no] ip igmp snooping vlan vlan-id static ip-address interface
```

- *vlan-id* - VLAN ID (Range: 1-4094)
- *ip-address* - IP address for multicast group
- *interface*
  - **ethernet** *unit/port*
    - *unit* - Stack unit. (Range: 1)
    - *port* - Port number. (Range: 1-28)
  - **port-channel** *channel-id* (Range: 1-8)

### Default Setting

None

### Command Mode

Global Configuration

### Example

The following shows how to statically configure a multicast group on a port:

```
Console(config)#ip igmp snooping vlan 1 static 224.0.0.12 ethernet 1/5
Console(config)#
```

### ip igmp snooping version

This command configures the IGMP snooping version. Use the **no** form to restore the default.

#### Syntax

```
ip igmp snooping version {1 | 2 | 3}  
no ip igmp snooping version
```

- **1** - IGMP Version 1
- **2** - IGMP Version 2
- **3** - IGMP Version 3

#### Default Setting

IGMP Version 2

#### Command Mode

Global Configuration

#### Command Usage

- All systems on the subnet must support the same version. If there are legacy devices in your network that only support Version 1, you will also have to configure this switch to use Version 1.
- Some commands are only enabled for IGMPv2 and/or v3, including **ip igmp snooping querier**, **ip igmp snooping query-max-response-time**, **ip igmp snooping query-interval**, and **ip igmp snooping immediate leave**.

#### Example

The following configures the switch to use IGMP Version 1:

```
Console(config)#ip igmp snooping version 1  
Console(config)#
```

### ip igmp snooping leave-proxy

This command enables IGMP leave proxy on the switch. Use the **no** form to disable the feature.

#### Syntax

```
[no] ip igmp snooping leave-proxy
```

#### Default Setting

Disabled

#### Command Mode

Global Configuration

## Command Usage

- The IGMP snooping leave-proxy feature suppresses all unnecessary IGMP leave messages so that the non-querier switch forwards an IGMP leave packet only when the last dynamic member port leaves a multicast group.
- The leave-proxy feature does not function when a switch is set as the querier.

## Example

```
Console(config)#ip igmp snooping leave-proxy
Console(config)#
```

## ip igmp snooping immediate-leave

This command immediately deletes a member port of a multicast service if a leave packet is received at that port and immediate-leave is enabled for the parent VLAN. Use the **no** form to restore the default.

## Syntax

```
[no] ip igmp snooping immediate-leave vlan-id
      vlan-id - VLAN ID (1 to 4094)
```

## Default Setting

Disabled

## Command Mode

Interface Configuration (VLAN)

## Command Usage

- If immediate-leave is *not* used, a multicast router (or querier) will send a group-specific query message when an IGMPv2 or IGMPv3 group leave message is received. The router/querier stops forwarding traffic for that group only if no host replies to the query within the specified timeout period. Note that the timeout period is determined by **ip igmp snooping query-max-response-time** (see 4-329).
- If immediate-leave is enabled, the switch assumes that only one host is connected to the interface. Therefore, immediate leave should only be enabled on an interface if it is connected to only one IGMP-enabled device, either a service host or a neighbor running IGMP snooping.
- This command is only effective if IGMP snooping is enabled, and IGMPv2 or IGMPv3 snooping is used.

## Example

The following shows how to enable immediate leave.

```
Console(config)#interface vlan 1
Console(config-if)#ip igmp snooping immediate-leave
Console(config-if)#
```

### show ip igmp snooping

This command shows the IGMP snooping configuration.

#### Default Setting

None

#### Command Mode

Privileged Exec

#### Command Usage

See “Configuring IGMP Snooping and Query Parameters” on page 3-249 for a description of the displayed items.

#### Example

The following shows the current IGMP snooping configuration:

```
Console#show ip igmp snooping
Service status:           Enabled
Querier status:           Enabled
Leave proxy status:        Disabled
Query count:              10
Query interval:           100 sec
Query max response time:  20 sec
Router port expire time:  300 sec
Immediate Leave Processing: Disabled on all VLAN
IGMP snooping version:    Version 2
Console#
```

### show mac-address-table multicast

This command shows known multicast addresses.

#### Syntax

```
show mac-address-table multicast [vlan vlan-id] [user | igmp-snooping]
```

- *vlan-id* - VLAN ID (1 to 4094)
- **user** - Display only the user-configured multicast entries.
- **igmp-snooping** - Display only entries learned through IGMP snooping.

#### Default Setting

None

#### Command Mode

Privileged Exec

#### Command Usage

Member types displayed include IGMP or USER, depending on selected options.



## Example

The following shows the multicast entries learned through IGMP snooping for VLAN 1:

```

Console#show mac-address-table multicast vlan 1 igmp-snooping
VLAN M'cast IP addr. Member ports Type
-----
  1      224.1.1.2.3      Eth1/11      IGMP
Console#

```

## IGMP Query Commands (Layer 2)

This section describes commands used to configure Layer 2 IGMP query on the switch.

**Table 4-88 IGMP Query Commands (Layer 2)**

Command	Function	Mode	Page
ip igmp snooping querier	Allows this device to act as the querier for IGMP snooping	GC	4-327
ip igmp snooping query-count	Configures the query count	GC	4-328
ip igmp snooping query-interval	Configures the query interval	GC	4-328
ip igmp snooping query-max-response-time	Configures the report delay	GC	4-329
ip igmp snooping router-port-expire-time	Configures the query timeout	GC	4-330

### ip igmp snooping querier

This command enables the switch as an IGMP querier. Use the **no** form to disable it.

#### Syntax

**[no] ip igmp snooping querier**

#### Default Setting

Enabled

#### Command Mode

Global Configuration

#### Command Usage

- IGMP snooping querier is not supported for IGMPv3 snooping (see **ip igmp snooping version**, page 4-324).
- If enabled, the switch will serve as querier if elected. The querier is responsible for asking hosts if they want to receive multicast traffic.

### Example

```
Console(config)#ip igmp snooping querier
Console(config)#
```

### ip igmp snooping query-count

This command configures the query count. Use the **no** form to restore the default.

#### Syntax

```
ip igmp snooping query-count count
no ip igmp snooping query-count
```

*count* - The maximum number of queries issued for which there has been no response before the switch takes action to drop a client from the multicast group. (Range: 2-10)

#### Default Setting

2 times

#### Command Mode

Global Configuration

#### Command Usage

The query count defines how long the querier waits for a response from a multicast client before taking action. If a querier has sent a number of queries defined by this command, but a client has not responded, a countdown timer is started using the time defined by **ip igmp snooping query-max-response-time**. If the countdown finishes, and the client still has not responded, then that client is considered to have left the multicast group.

### Example

The following shows how to configure the query count to 10:

```
Console(config)#ip igmp snooping query-count 10
Console(config)#
```

#### Related Commands

ip igmp snooping query-max-response-time (4-329)

### ip igmp snooping query-interval

This command configures the query interval. Use the **no** form to restore the default.

#### Syntax

```
ip igmp snooping query-interval seconds
no ip igmp snooping query-interval
```

*seconds* - The frequency at which the switch sends IGMP host-query messages. (Range: 60-125)

### Default Setting

125 seconds

### Command Mode

Global Configuration

### Example

The following shows how to configure the query interval to 100 seconds:

```
Console(config)#ip igmp snooping query-interval 100
Console(config)#
```

### ip igmp snooping query-max-response-time

This command configures the query report delay. Use the **no** form to restore the default.

### Syntax

**ip igmp snooping query-max-response-time** *seconds*  
**no ip igmp snooping query-max-response-time**

*seconds* - The report delay advertised in IGMP queries. (Range: 5-25)

### Default Setting

10 seconds

### Command Mode

Global Configuration

### Command Usage

- The switch must be using IGMPv2 or v3 snooping for this command to take effect.
- This command defines the time after a query, during which a response is expected from a multicast client. If a querier has sent a number of queries defined by the **ip igmp snooping query-count**, but a client has not responded, a countdown timer is started using an initial value set by this command. If the countdown finishes, and the client still has not responded, then that client is considered to have left the multicast group.

### Example

The following shows how to configure the maximum response time to 20 seconds:

```
Console(config)#ip igmp snooping query-max-response-time 20
Console(config)#
```

### Related Commands

ip igmp snooping version (4-324)

## ip igmp snooping router-port-expire-time

This command configures the query timeout. Use the **no** form to restore the default.

### Syntax

**ip igmp snooping router-port-expire-time** *seconds*  
**no ip igmp snooping router-port-expire-time**

*seconds* - The time the switch waits after the previous querier stops before it considers the router port (i.e., the interface which had been receiving query packets) to have expired.  
(Range: 300-500)

### Default Setting

300 seconds

### Command Mode

Global Configuration

### Command Usage

The switch must use IGMPv2 or v3 snooping for this command to take effect.

### Example

The following shows how to configure the default timeout to 300 seconds:

```
Console(config)#ip igmp snooping router-port-expire-time 300
Console(config)#
```

### Related Commands

ip igmp snooping version (4-324)

## Static Multicast Routing Commands

This section describes commands used to configure static multicast routing on the switch.

**Table 4-89 Static Multicast Routing Commands**

Command	Function	Mode	Page
ip igmp snooping vlan mrouter	Adds a multicast router port	GC	4-331
show ip igmp snooping mrouter	Shows multicast router ports	PE	4-331

## ip igmp snooping vlan mrouter

This command statically configures a multicast router port. Use the **no** form to remove the configuration.

### Syntax

**[no] ip igmp snooping vlan *vlan-id* mrouter *interface***

- *vlan-id* - VLAN ID (Range: 1-4094)
- *interface*
  - **ethernet** *unit/port*
    - *unit* - Stack unit. (Range: 1)
    - *port* - Port number. (Range: 1-28)
  - **port-channel** *channel-id* (Range: 1-8)

### Default Setting

No static multicast router ports are configured.

### Command Mode

Global Configuration

### Command Usage

Depending on your network connections, IGMP snooping may not always be able to locate the IGMP querier. Therefore, if the IGMP querier is a known multicast router/switch connected over the network to an interface (port or trunk) on your router, you can manually configure that interface to join all the current multicast groups.

### Example

The following shows how to configure port 11 as a multicast router port within VLAN 1:

```
Console(config)#ip igmp snooping vlan 1 mrouter ethernet 1/11
Console(config)#
```

## show ip igmp snooping mrouter

This command displays information on statically configured and dynamically learned multicast router ports.

### Syntax

**show ip igmp snooping mrouter [vlan *vlan-id*]**

*vlan-id* - VLAN ID (Range: 1-4094)

### Default Setting

Displays multicast router ports for all configured VLANs.

### Command Mode

Privileged Exec

## Command Usage

Multicast router port types displayed include Static.

## Example

The following shows that port 11 in VLAN 1 is attached to a multicast router:

```
Console#show ip igmp snooping mrouter vlan 1
VLAN M'cast Router Ports Type
-----
 1                Eth 1/11  Static
 2                Eth 1/12  Static
Console#
```

## IGMP Filtering and Throttling Commands

In certain switch applications, the administrator may want to control the multicast services that are available to end users. For example, an IP/TV service based on a specific subscription plan. The IGMP filtering feature fulfills this requirement by restricting access to specified multicast services on a switch port, and IGMP throttling limits the number of simultaneous multicast groups a port can join.

**Table 4-90 IGMP Filtering and Throttling Commands**

Command	Function	Mode	Page
ip igmp filter	Enables IGMP filtering and throttling on the switch	GC	4-333
ip igmp profile	Sets a profile number and enters IGMP filter profile configuration mode	GC	4-333
permit, deny	Sets a profile access mode to permit or deny	IPC	4-334
range	Specifies one or a range of multicast addresses for a profile	IPC	4-334
ip igmp filter	Assigns an IGMP filter profile to an interface	IC	4-335
ip igmp max-groups	Specifies an IGMP throttling number for an interface	IC	4-336
ip igmp max-groups action	Sets the IGMP throttling action for an interface	IC	4-336
show ip igmp filter	Displays the IGMP filtering status	PE	4-337
show ip igmp profile	Displays IGMP profiles and settings	PE	4-338
show ip igmp throttle interface	Displays the IGMP throttling setting for interfaces	PE	4-338

**ip igmp filter** (Global Configuration)

This command globally enables IGMP filtering and throttling on the switch. Use the **no** form to disable the feature.

**Syntax**

**[no] ip igmp filter**

**Default Setting**

Disabled

**Command Mode**

Global Configuration

**Command Usage**

- IGMP filtering enables you to assign a profile to a switch port that specifies multicast groups that are permitted or denied on the port. An IGMP filter profile can contain one or more, or a range of multicast addresses; but only one profile can be assigned to a port. When enabled, IGMP join reports received on the port are checked against the filter profile. If a requested multicast group is permitted, the IGMP join report is forwarded as normal. If a requested multicast group is denied, the IGMP join report is dropped.
- IGMP filtering and throttling only applies to dynamically learned multicast groups, it does not apply to statically configured groups.
- The IGMP filtering feature operates in the same manner when MVR is used to forward multicast traffic.

**Example**

```
Console(config)#ip igmp filter
Console(config)#
```

**ip igmp profile**

This command creates an IGMP filter profile number and enters IGMP profile configuration mode. Use the **no** form to delete a profile number.

**Syntax**

**[no] ip igmp profile *profile-number***

*profile-number* - An IGMP filter profile number. (Range: 1-4294967295)

**Default Setting**

Disabled

**Command Mode**

Global Configuration

## 4 Command Line Interface

### Command Usage

A profile defines the multicast groups that a subscriber is permitted or denied to join. The same profile can be applied to many interfaces, but only one profile can be assigned to one interface. Each profile has only one access mode; either permit or deny.

### Example

```
Console(config)#ip igmp profile 19
Console(config-igmp-profile)#
```

### permit, deny

This command sets the access mode for an IGMP filter profile. Use the **no** form to delete a profile number.

### Syntax

```
{permit | deny}
```

### Default Setting

Deny

### Command Mode

IGMP Profile Configuration

### Command Usage

- Each profile has only one access mode; either permit or deny.
- When the access mode is set to permit, IGMP join reports are processed when a multicast group falls within the controlled range. When the access mode is set to deny, IGMP join reports are only processed when a multicast group is not in the controlled range.

### Example

```
Console(config)#ip igmp profile 19
Console(config-igmp-profile)#permit
Console(config-igmp-profile)#
```

### range

This command specifies multicast group addresses for a profile. Use the **no** form to delete addresses from a profile.

### Syntax

```
[no] range low-ip-address [high-ip-address]
```

- *low-ip-address* - A valid IP address of a multicast group or start of a group range.
- *high-ip-address* - A valid IP address for the end of a multicast group range.

### Default Setting

None



**Command Mode**

IGMP Profile Configuration

**Command Usage**

Enter this command multiple times to specify more than one multicast address or address range for a profile.

**Example**

```
Console(config)#ip igmp profile 19
Console(config-igmp-profile)#range 239.1.1.1
Console(config-igmp-profile)#range 239.2.3.1 239.2.3.100
Console(config-igmp-profile)#
```

**ip igmp filter** (Interface Configuration)

This command assigns an IGMP filtering profile to an interface on the switch. Use the **no** form to remove a profile from an interface.

**Syntax**

**[no] ip igmp filter *profile-number***

*profile-number* - An IGMP filter profile number. (Range: 1-4294967295)

**Default Setting**

None

**Command Mode**

Interface Configuration

**Command Usage**

- The IGMP filtering profile must first be created with the **ip igmp profile** command before being able to assign it to an interface.
- Only one profile can be assigned to an interface.
- A profile can also be assigned to a trunk interface. When ports are configured as trunk members, the trunk uses the filtering profile assigned to the first port member in the trunk.

**Example**

```
Console(config)#interface ethernet 1/1
Console(config-if)#ip igmp filter 19
Console(config-if)#
```

### ip igmp max-groups

This command sets the IGMP throttling number for an interface on the switch. Use the **no** form to restore the default setting.

#### Syntax

```
ip igmp max-groups number  
no ip igmp max-groups
```

*number* - The maximum number of multicast groups an interface can join at the same time. (Range: 0-64)

#### Default Setting

64

#### Command Mode

Interface Configuration

#### Command Usage

- IGMP throttling sets a maximum number of multicast groups that a port can join at the same time. When the maximum number of groups is reached on a port, the switch can take one of two actions; either “deny” or “replace.” If the action is set to deny, any new IGMP join reports will be dropped. If the action is set to replace, the switch randomly removes an existing group and replaces it with the new multicast group.
- IGMP throttling can also be set on a trunk interface. When ports are configured as trunk members, the trunk uses the throttling settings of the first port member in the trunk.

#### Example

```
Console(config)#interface ethernet 1/1  
Console(config-if)#ip igmp max-groups 10  
Console(config-if)#
```

### ip igmp max-groups action

This command sets the IGMP throttling action for an interface on the switch.

#### Syntax

```
ip igmp max-groups action {replace | deny}
```

- **replace** - The new multicast group replaces an existing group.
- **deny** - The new multicast group join report is dropped.

#### Default Setting

Deny

#### Command Mode

Interface Configuration

## Command Usage

When the maximum number of groups is reached on a port, the switch can take one of two actions; either “deny” or “replace.” If the action is set to deny, any new IGMP join reports will be dropped. If the action is set to replace, the switch randomly removes an existing group and replaces it with the new multicast group.

## Example

```
Console(config)#interface ethernet 1/1
Console(config-if)#ip igmp max-groups action replace
Console(config-if)#
```

## show ip igmp filter

This command displays the global and interface settings for IGMP filtering.

## Syntax

**show ip igmp filter** [*interface interface*]

*interface*

- **ethernet** *unit/port*
  - *unit* - Stack unit. (Range: 1)
  - *port* - Port number. (Range: 1-28)
- **port-channel** *channel-id* (Range: 1-8)

## Default Setting

None

## Command Mode

Privileged Exec

## Example

```
Console#show ip igmp filter
IGMP filter enabled
Console#show ip igmp filter interface ethernet 1/1
Ethernet 1/1 information
-----
IGMP Profile 19
Deny
range 239.1.1.1 239.1.1.1
range 239.2.3.1 239.2.3.100
Console#
```

## 4 Command Line Interface

### show ip igmp profile

This command displays IGMP filtering profiles created on the switch.

#### Syntax

```
show ip igmp profile [profile-number]
```

*profile-number* - An existing IGMP filter profile number.  
(Range: 1-4294967295)

#### Default Setting

None

#### Command Mode

Privileged Exec

#### Example

```
Console#show ip igmp profile
IGMP Profile 19
IGMP Profile 50
Console#show ip igmp profile 19
IGMP Profile 19
  Deny
  range 239.1.1.1 239.1.1.1
  range 239.2.3.1 239.2.3.100
Console#
```

### show ip igmp throttle interface

This command displays the interface settings for IGMP throttling.

#### Syntax

```
show ip igmp throttle interface [interface]
```

*interface*

- **ethernet** *unit/port*
  - *unit* - Stack unit. (Range: 1)
  - *port* - Port number. (Range: 1-28)
- **port-channel** *channel-id* (Range: 1-8)

#### Default Setting

None

#### Command Mode

Privileged Exec

#### Command Usage

Using this command without specifying an interface displays all interfaces.

## Example

```

Console#show ip igmp throttle interface ethernet 1/1
Eth 1/1 Information
  Status : TRUE
  Action : Deny
  Max Multicast Groups : 32
  Current Multicast Groups : 0

Console#

```

## Multicast VLAN Registration Commands

This section describes commands used to configure Multicast VLAN Registration (MVR). A single network-wide VLAN can be used to transmit multicast traffic (such as television channels) across a service provider's network. Any multicast traffic entering an MVR VLAN is sent to all subscribers. This can significantly reduce to processing overhead required to dynamically monitor and establish the distribution tree for a normal multicast VLAN. Also note that MVR maintains the user isolation and data security provided by VLAN segregation by passing only multicast traffic into other VLANs to which the subscribers belong.

**Table 4-91 Multicast VLAN Registration Commands**

Command	Function	Mode	Page
mvr	Globally enables MVR, statically configures MVR group address(es), or specifies the MVR VLAN identifier	GC	4-339
mvr	Configures an interface as an MVR receiver or source port, enables immediate leave capability, or configures an interface as a static member of the MVR VLAN	IC	4-341
show mvr	Shows information about the global MVR configuration settings, the interfaces attached to the MVR VLAN, or the multicast groups assigned to the MVR VLAN	PE	4-342

### mvr (Global Configuration)

This command enables Multicast VLAN Registration (MVR) globally on the switch, statically configures MVR multicast group IP address(es) using the **group** keyword, or specifies the MVR VLAN identifier using the **vlan** keyword. Use the **no** form of this command without any keywords to globally disable MVR. Use the **no** form with the **group** keyword to remove a specific address or range of addresses. Or use the **no** form with the **vlan** keyword restore the default MVR VLAN.

### Syntax

**[no] mvr [group ip-address [count] | vlan vlan-id]**

- **ip-address** - IP address for an MVR multicast group.  
(Range: 224.0.1.0 - 239.255.255.255)
- **count** - The number of contiguous MVR group addresses. (Range: 1-255)
- **vlan-id** - MVR VLAN ID (Range: 1-4094)

### Default Setting

- MVR is disabled.
- No MVR group address is defined.
- The default number of contiguous addresses is 0.
- MVR VLAN ID is 1.

### Command Mode

Global Configuration

### Command Usage

- Use the **mvr group** command to statically configure all multicast group addresses that will join the MVR VLAN. Any multicast data associated an MVR group is sent from all source ports, and to all receiver ports that have registered to receive data from that multicast group.
- The IP address range from 224.0.0.0 to 239.255.255.255 is used for multicast streams. MVR group addresses cannot fall within the reserved IP multicast address range of 224.0.0.x.
- MVR source ports can be configured as members of the MVR VLAN using the **switchport allowed vlan** command (page 4-258) and **switchport native vlan** command (page 4-257), but MVR receiver ports should not be statically configured as members of this VLAN.
- IGMP snooping must be enabled to allow a subscriber to dynamically join or leave an MVR group (see **ip igmp snooping** on page 4-323). Note that only IGMP version 2 or 3 hosts can issue multicast join or leave messages.
- IGMP snooping and MVR share a maximum number of 255 groups. Any multicast streams received in excess of this limitation will be flooded to all ports in the associated VLAN.

### Example

The following example enables MVR globally, and configures a range of MVR group addresses:

```
Console(config)#mvr
Console(config)#mvr group 228.1.23.1 10
Console(config)#
```

## mvr (Interface Configuration)

This command configures an interface as an MVR receiver or source port using the **type** keyword, enables immediate leave capability using the **immediate** keyword, or configures an interface as a static member of the MVR VLAN using the **group** keyword. Use the **no** form to restore the default settings.

### Syntax

```
[no] mvr {type {receiver | source} | immediate | group ip-address}
```

- **receiver** - Configures the interface as a subscriber port that can receive multicast data.
- **source** - Configure the interface as an uplink port that can send and receive multicast data for the configured multicast groups.
- **immediate** - Configures the switch to immediately remove an interface from a multicast stream as soon as it receives a leave message for that group.
- **ip-address** - Statically configures an interface to receive multicast traffic from the IP address specified for an MVR multicast group.  
(Range: 224.0.1.0 - 239.255.255.255)

### Default Setting

- The port type is not defined.
- Immediate leave is disabled.
- No receiver port is a member of any configured multicast group.

### Command Mode

Interface Configuration (Ethernet, Port Channel)

### Command Usage

- A port which is not configured as an MVR receiver or source port can use IGMP snooping to join or leave multicast groups using the standard rules for multicast filtering.
- Receiver ports can belong to different VLANs, but should not be configured as a member of the MVR VLAN. IGMP snooping can be used to allow a receiver port to dynamically join or leave multicast groups within the MVR VLAN. Multicast groups can also be statically assigned to a receiver port using the **group** keyword. However, if a receiver port is statically configured as a member of an MVR VLAN, its status will be inactive. Also, note that VLAN membership for MVR receiver ports cannot be set to trunk mode (see the **switchport mode** command on page 4-255).
- One or more interfaces may be configured as MVR source ports. A source port is able to both receive and send data for multicast groups which it has joined through IGMP snooping or which have been statically assigned using the **group** keyword.
- The IP address range from 224.0.0.0 to 239.255.255.255 is used for multicast streams. MVR group addresses cannot fall within the reserved IP multicast address range of 224.0.0.x.

- Immediate leave applies only to receiver ports. When enabled, the receiver port is immediately removed from the multicast group identified in the leave message. When immediate leave is disabled, the switch follows the standard rules by sending a group-specific query to the receiver port and waiting for a response to determine if there are any remaining subscribers for that multicast group before removing the port from the group list.
- Using immediate leave can speed up leave latency, but should only be enabled on a port attached to one multicast subscriber to avoid disrupting services to other group members attached to the same interface.
- Immediate leave does not apply to multicast groups which have been statically assigned to a port.
- IGMP snooping must be enabled to allow a subscriber to dynamically join or leave an MVR group (see **ip igmp snooping** on page 4-323). Note that only IGMP version 2 or 3 hosts can issue multicast join or leave messages.

### Example

The following configures one source port and several receiver ports on the switch, enables immediate leave on one of the receiver ports, and statically assigns a multicast group to another receiver port:

```
Console(config)#interface ethernet 1/5
Console(config-if)#mvr type source
Console(config-if)#exit
Console(config)#interface ethernet 1/6
Console(config-if)#mvr type receiver
Console(config-if)#mvr immediate
Console(config-if)#exit
Console(config)#interface ethernet 1/7
Console(config-if)#mvr type receiver
Console(config-if)#mvr group 225.0.0.5
Console(config-if)#
```

### show mvr

This command shows information about the global MVR configuration settings when entered without any keywords, the interfaces attached to the MVR VLAN using the **interface** keyword, or the multicast groups assigned to the MVR VLAN using the **members** keyword.

### Syntax

**show mvr** [**interface** *[interface]* | **members** *[ip-address]*]

- *interface*
  - **ethernet** *unit/port*
    - *unit* - Stack unit. (Range: 1)
    - *port* - Port number. (Range: 1-28)
  - **port-channel** *channel-id* (Range: 1-8)
- *ip-address* - IP address for an MVR multicast group. (Range: 224.0.1.0 - 239.255.255.255)



### Default Setting

Displays global configuration settings for MVR when no keywords are used.

### Command Mode

Privileged Exec

### Command Usage

Enter this command without any keywords to display the global settings for MVR. Use the **interface** keyword to display information about interfaces attached to the MVR VLAN. Or use the **members** keyword to display information about multicast groups assigned to the MVR VLAN.

### Example

The following shows the global MVR settings:

```
Console#show mvr
MVR Status:enable
MVR running status:TRUE
MVR multicast vlan:1
MVR Max Multicast Groups:255
MVR Current multicast groups:10
Console#
```

**Table 4-92** show mvr - display description

Field	Description
MVR Status	Shows if MVR is globally enabled on the switch.
MVR running status	Indicates whether or not all necessary conditions in the MVR environment are satisfied.
MVR multicast vlan	Shows the VLAN used to transport all MVR multicast traffic.
MVR Max Multicast Groups	Shows the maximum number of multicast groups which can assigned to the MVR VLAN.
MVR Current multicast groups	Shows the number of multicast groups currently assigned to the MVR VLAN.

The following displays information about the interfaces attached to the MVR VLAN:

```
Console#show mvr interface
Port      Type           Status           Immediate Leave
-----
eth1/1    SOURCE         ACTIVE/UP        Disable
eth1/2    RECEIVER      ACTIVE/UP        Disable
eth1/5    RECEIVER      INACTIVE/DOWN   Disable
eth1/6    RECEIVER      INACTIVE/DOWN   Disable
eth1/7    RECEIVER      INACTIVE/DOWN   Disable
Console#
```

**Table 4-93** show mvr interface - display description

Field	Description
Port	Shows interfaces attached to the MVR.
Type	Shows the MVR port type.

**Table 4-93 show mvr interface - display description (Continued)**

Field	Description
Status	Shows the MVR status and interface status. MVR status for source ports is "ACTIVE" if MVR is globally enabled on the switch. MVR status for receiver ports is "ACTIVE" only if there are subscribers receiving multicast traffic from one of the MVR groups, or a multicast group has been statically assigned to an interface.
Immediate Leave	Shows if immediate leave is enabled or disabled.

The following shows information about the interfaces associated with multicast groups assigned to the MVR VLAN:

```

Console#show mvr members
MVR Group IP      Status      Members
-----
225.0.0.1         ACTIVE     eth1/1(d), eth1/2(s)
225.0.0.2         INACTIVE   None
225.0.0.3         INACTIVE   None
225.0.0.4         INACTIVE   None
225.0.0.5         INACTIVE   None
225.0.0.6         INACTIVE   None
225.0.0.7         INACTIVE   None
225.0.0.8         INACTIVE   None
225.0.0.9         INACTIVE   None
225.0.0.10        INACTIVE   None
Console#
  
```

**Table 4-94 show mvr members - display description**

Field	Description
MVR Group IP	Multicast groups assigned to the MVR VLAN.
Status	Shows whether or not there are active subscribers for this multicast group. Note that this field will also display "INACTIVE" if MVR is globally disabled.
Members	Shows the interfaces with subscribers for multicast services provided through the MVR VLAN. Also shows if an interface has dynamically joined a multicast group (d), or if a multicast group has been statically bound to the interface (s).

## IP Interface Commands

An IP addresses may be used for management access to the switch over your network. The IP address for this switch is obtained via DHCP by default. You can manually configure a specific IP address, or direct the device to obtain an address from a BOOTP or DHCP server when it is powered on. You may also need to establish a default gateway between this device and management stations or other devices that exist on another network segment.

**Table 4-95 IP Interface Commands**

Command	Function	Mode	Page
ip address	Sets the IP address for the current interface	IC	4-345
ip default-gateway	Defines the default gateway through which this switch can reach other subnetworks	GC	4-346
ip dhcp restart	Submits a BOOTP or DHCP client request	PE	4-347
show ip interface	Displays the IP settings for this device	PE	4-347
show ip redirects	Displays the default gateway configured for this device	PE	4-348
ping	Sends ICMP echo request packets to another node on the network	NE, PE	4-348

### ip address

This command sets the IP address for the currently selected VLAN interface. Use the **no** form to restore the default IP address.

### Syntax

**ip address** {*ip-address netmask* | **bootp** | **dhcp**}  
**no ip address**

- *ip-address* - IP address
- *netmask* - Network mask for the associated IP subnet. This mask identifies the host address bits used for routing to specific subnets.
- **bootp** - Obtains IP address from BOOTP.
- **dhcp** - Obtains IP address from DHCP.

### Default Setting

DHCP

### Command Mode

Interface Configuration (VLAN)

### Command Usage

- You must assign an IP address to this device to gain management access over the network. You can manually configure a specific IP address, or direct the device to obtain an address from a BOOTP or DHCP server. Valid IP addresses consist of four numbers, 0 to 255, separated by periods. Anything outside this format will not be accepted by the configuration program.

## 4 Command Line Interface

- If you select the **bootp** or **dhcp** option, IP is enabled but will not function until a BOOTP or DHCP reply has been received. Requests will be broadcast periodically by this device in an effort to learn its IP address. (BOOTP and DHCP values can include the IP address, default gateway, and subnet mask).
- You can start broadcasting BOOTP or DHCP requests by entering an **ip dhcp restart** command, or by rebooting the switch.

**Note:** Only one VLAN interface can be assigned an IP address (the default is VLAN 1). This defines the management VLAN, the only VLAN through which you can gain management access to the switch. If you assign an IP address to any other VLAN, the new IP address overrides the original IP address and this becomes the new management VLAN.

### Example

In the following example, the device is assigned an address in VLAN 1.

```
Console(config)#interface vlan 1
Console(config-if)#ip address 192.168.1.5 255.255.255.0
Console(config-if)#
```

### Related Commands

ip dhcp restart (4-347)

### ip default-gateway

This command establishes a static route between this switch and devices that exist on another network segment. Use the **no** form to remove the static route.

### Syntax

**ip default-gateway** *gateway*  
**no ip default-gateway**

*gateway* - IP address of the default gateway

### Default Setting

No static route is established.

### Command Mode

Global Configuration

### Command Usage

- A gateway must be defined if the management station is located in a different IP segment.
- An default gateway can only be successfully set when a network interface that directly connects to the gateway has been configured on the switch.

### Example

The following example defines a default gateway for this device:

```
Console(config)#ip default-gateway 10.1.1.254
Console(config)#
```

**Related Commands**

show ip redirects (4-348)

**ip dhcp restart**

This command submits a BOOTP or DHCP client request.

**Default Setting**

None

**Command Mode**

Privileged Exec

**Command Usage**

- This command issues a BOOTP or DHCP client request for any IP interface that has been set to BOOTP or DHCP mode via the **ip address** command.
- DHCP requires the server to reassign the client's last address if available.
- If the BOOTP or DHCP server has been moved to a different domain, the network portion of the address provided to the client will be based on this new domain.

**Example**

In the following example, the device is reassigned the same address.

```
Console(config)#interface vlan 1
Console(config-if)#ip address dhcp
Console(config-if)#end
Console#ip dhcp restart
Console#show ip interface
  IP address and netmask: 192.168.1.54 255.255.255.0 on VLAN 1,
  and address mode: DHCP.
Console#
```

**Related Commands**

ip address (4-345)

**show ip interface**

This command displays the settings of an IP interface.

**Default Setting**

All interfaces

**Command Mode**

Privileged Exec

**Example**

```
Console#show ip interface
  IP address and netmask: 192.168.1.54 255.255.255.0 on VLAN 1,
  and address mode:      User specified.
Console#
```

## 4 Command Line Interface

### Related Commands

show ip redirects (4-348)

### show ip redirects

This command shows the default gateway configured for this device.

### Default Setting

None

### Command Mode

Privileged Exec

### Example

```
Console#show ip redirects
IP default gateway 10.1.0.254
Console#
```

### Related Commands

ip default-gateway (4-346)

### ping

This command sends ICMP echo request packets to another node on the network.

### Syntax

**ping** *host* [**count** *count*][**size** *size*]

- *host* - IP address or IP alias of the host.
- *count* - Number of packets to send. (Range: 1-16)
- *size* - Number of bytes in a packet. (Range: 32-512)  
The actual packet size will be eight bytes larger than the size specified because the router adds header information.

### Default Setting

count: 5

size: 32

### Command Mode

Normal Exec, Privileged Exec

### Command Usage

- Use the ping command to see if another site on the network can be reached.
- Following are some results of the **ping** command:
  - *Normal response* - The normal response occurs in one to ten seconds, depending on network traffic.
  - *Destination does not respond* - If the host does not respond, a “timeout” appears in ten seconds.
  - *Destination unreachable* - The gateway for this destination indicates that the destination is unreachable.

- *Network or host unreachable* - The gateway found no corresponding entry in the route table.
- Press <Esc> to stop pinging.

### Example

```
Console#ping 10.1.0.9
Type ESC to abort.
PING to 10.1.0.9, by 5 32-byte payload ICMP packets, timeout is 5 seconds
response time: 10 ms
response time: 10 ms
response time: 10 ms
response time: 10 ms
response time: 10 ms
Ping statistics for 10.1.0.9:
    5 packets transmitted, 5 packets received (100%), 0 packets lost (0%)
Approximate round trip times:
    Minimum = 10 ms, Maximum = 20 ms, Average = 10 ms
Console#
```

### Related Commands

interface (4-187)



**This page is intentionally left blank.**



# Appendix A: Software Specifications

---

## Software Features

### Management Authentication

Local, RADIUS, TACACS, Port Authentication (802.1X), MAC Authentication, Web Authentication, HTTPS, SSH

### General Security Measures

Access Control Lists (IP, MAC - 100 rules), Port Authentication (802.1X), Port Security, DHCP Snooping (with Option 82 relay information), IP Source Guard

### Power over Ethernet

### DHCP Client

### Port Configuration

100BASE-TX: 10/100 Mbps, half/full duplex

1000BASE-T: 10/100 Mbps at half/full duplex, 1000 Mbps at full duplex (RJ-45)

1000BASE-SX/LX/LH - 1000 Mbps at full duplex<sup>30</sup> (SFP)

### Flow Control

Full Duplex: IEEE 802.3-2005

Half Duplex: Back pressure

### Broadcast Storm Control

Traffic throttled above a critical threshold

### Port Mirroring

Multiple source ports, one destination port

### Rate Limits

Input limit

Output limit

### Port Trunking

Static trunks (Cisco EtherChannel compliant)

Dynamic trunks (Link Aggregation Control Protocol)

### Spanning Tree Algorithm

Spanning Tree Protocol (STP, IEEE 802.1D)

Rapid Spanning Tree Protocol (RSTP, IEEE 802.1w)

Multiple Spanning Tree Protocol (MSTP, IEEE 802.1s)

### VLAN Support

Up to 255 groups; port-based protocol-based, or tagged (802.1Q),

GVRP for automatic VLAN learning, private VLANs, voice VLANs, QinQ tunnel

### Class of Service

Supports 4 levels of priority

Strict or Weighted Round Robin queueing

---

30. Supported duplex modes depend on the specific transceiver.



CoS configured by port or VLAN tag  
Layer 3/4 priority mapping: IP DSCP

#### Multicast Filtering

IGMP Snooping (Layer 2)  
Multicast VLAN Registration

#### Quality of Service

DiffServ supports class maps, policy maps, and service policies

#### Additional Features

BOOTP client  
Link Layer Discovery Protocol  
SNTP (Simple Network Time Protocol)  
SNMP (Simple Network Management Protocol)  
RMON (Remote Monitoring, groups 1,2,3,9)  
SMTP Email Alerts  
DHCP Snooping  
IP Source Guard  
Switch Clustering

## Management Features

#### In-Band Management

Telnet, Web-based HTTP or HTTPS, SNMP manager, or Secure Shell

#### Out-of-Band Management

RS-232 DB-9 console port

#### Software Loading

TFTP in-band or XModem out-of-band

#### SNMP

Management access via MIB database  
Trap management to specified hosts

#### RMON

Groups 1, 2, 3, 9 (Statistics, History, Alarm, Event)

## Standards

IEEE 802.1AB Link Layer Discovery Protocol  
IEEE 802.1D Spanning Tree Protocol and traffic priorities  
IEEE 802.1p Priority tags  
IEEE 802.1Q VLAN  
IEEE 802.1s Multiple Spanning Tree Protocol  
IEEE 802.1v Protocol-based VLANs  
IEEE 802.1w Rapid Spanning Tree Protocol  
IEEE 802.1X Port Authentication  
IEEE 802.3-2005  
Ethernet, Fast Ethernet, Gigabit Ethernet

Link Aggregation Control Protocol (LACP)  
Full-duplex flow control (ISO/IEC 8802-3)  
IEEE 802.3ac VLAN tagging  
IEEE 802.3af-2003 Power over Ethernet (PoE)  
DHCP Client (RFC 2131)  
DHCP Options (RFC 2132)  
HTTPS  
IGMPv1 (RFC 1112)  
IGMPv2 (RFC 2236)  
IGMPv3 (RFC 3376) - partial support  
RADIUS+ (RFC 2618)  
RMON (RFC 1757 groups 1,2,3,9)  
SNMP (RFC 1157)  
SNMPv2c (RFC 1901)  
SNMPv3 (RFC DRAFT 2273, 2576, 3410, 3411, 3413, 3414, 3415)  
SNTP (RFC 2030)  
SSH (Version 2.0)  
TELNET (RFC 854, 855, 856)  
TFTP (RFC 1350)

## Management Information Bases

Bridge MIB (RFC 1493)  
Differentiated Services MIB (RFC 3289)  
Entity MIB (RFC 2737)  
Ether-like MIB (RFC 3635)  
Extended Bridge MIB (RFC 2674)  
Extensible SNMP Agents MIB (RFC 2742)  
Forwarding Table MIB (RFC 2096)  
IGMP MIB (RFC 2933)  
Interface Group MIB (RFC 2233)  
Interfaces Evolution MIB (RFC 2863)  
IP Multicasting related MIBs  
MAU MIB (RFC 3636)  
MIB II (RFC 1213)  
Port Access Entity MIB (IEEE 802.1X)  
Port Access Entity Equipment MIB  
Private MIB  
QnQ Tunneling (IEEE 802.1ad Provider Bridges)  
Quality of Service MIB  
RADIUS Accounting Server MIB (RFC 2621)  
RADIUS Authentication Client MIB (RFC 2618)  
RMON MIB (RFC 2819)  
RMON II Probe Configuration Group (RFC 2021, partial implementation)  
SNMPv2 IP MIB (RFC 2011)  
SNMP Community MIB (RFC 3584)



SNMP Framework MIB (RFC 3411)  
SNMP-MPD MIB (RFC 3412)  
SNMP Target MIB, SNMP Notification MIB (RFC 3413)  
SNMP User-Based SM MIB (RFC 3414)  
SNMP View Based ACM MIB (RFC 3415)  
TACACS+ Authentication Client MIB  
TCP MIB (RFC 2012)  
Trap (RFC 1215)  
UDP MIB (RFC 2013)

# Appendix B: Troubleshooting

---

## Problems Accessing the Management Interface

Table B-1 Troubleshooting Chart

Symptom	Action
Cannot connect using Telnet, web browser, or SNMP software	<ul style="list-style-type: none"><li>• Be sure the switch is powered up.</li><li>• Check network cabling between the management station and the switch.</li><li>• Check that you have a valid network connection to the switch and that the port you are using has not been disabled.</li><li>• Be sure you have configured the VLAN interface through which the management station is connected with a valid IP address, subnet mask and default gateway.</li><li>• Be sure the management station has an IP address in the same subnet as the switch's IP interface to which it is connected.</li><li>• If you are trying to connect to the switch via the IP address for a tagged VLAN group, your management station, and the ports connecting intermediate switches in the network, must be configured with the appropriate tag.</li><li>• If you cannot connect using Telnet, you may have exceeded the maximum number of concurrent Telnet/SSH sessions permitted. Try connecting again at a later time.</li></ul>
Cannot connect using Secure Shell	<ul style="list-style-type: none"><li>• If you cannot connect using SSH, you may have exceeded the maximum number of concurrent Telnet/SSH sessions permitted. Try connecting again at a later time.</li><li>• Be sure the control parameters for the SSH server are properly configured on the switch, and that the SSH client software is properly configured on the management station.</li><li>• Be sure you have generated both an RSA and DSA public key on the switch, exported this key to the SSH client, and enabled SSH service.</li><li>• Be sure you have set up an account on the switch for each SSH user, including user name, authentication level, and password.</li><li>• Be sure you have imported the client's public key to the switch (if public key authentication is used).</li></ul>
Cannot access the on-board configuration program via a serial port connection	<ul style="list-style-type: none"><li>• Be sure you have set the terminal emulator program to VT100 compatible, 8 data bits, 1 stop bit, no parity, and 9600 bps.</li><li>• Check that the null-modem serial cable conforms to the pin-out connections provided in the Installation Guide.</li></ul>
Forgot or lost the password	<ul style="list-style-type: none"><li>• Contact your local distributor.</li></ul>

## Using System Logs

If a fault does occur, refer to the Installation Guide to ensure that the problem you encountered is actually caused by the switch. If the problem appears to be caused by the switch, follow these steps:

1. Enable logging.
2. Set the error messages reported to include all categories.
3. Designate the SNMP host that is to receive the error messages.
4. Repeat the sequence of commands or other actions that lead up to the error.
5. Make a list of the commands or circumstances that led to the fault. Also make a list of any error messages displayed.
6. Contact your distributor's service engineer.

For example:

```
Console(config)#logging on
Console(config)#logging history flash 7
Console(config)#snmp-server host 192.168.1.23
:
```

# Glossary

---

## **Access Control List (ACL)**

ACLs can limit network traffic and restrict access to certain users or devices by checking each packet for certain IP or MAC (i.e., Layer 2) information.

## **Boot Protocol (BOOTP)**

BOOTP is used to provide bootup information for network devices, including IP address information, the address of the TFTP server that contains the devices system files, and the name of the boot file.

## **Class of Service (CoS)**

CoS is supported by prioritizing packets based on the required level of service, and then placing them in the appropriate output queue. Data is transmitted from the queues using weighted round-robin service to enforce priority service and prevent blockage of lower-level queues. Priority may be set according to the port default, the packet's priority bit (in the VLAN tag), TCP/UDP port number, or DSCP priority bit.

## **Differentiated Services Code Point Service (DSCP)**

DSCP uses a six-bit tag to provide for up to 64 different forwarding behaviors. Based on network policies, different kinds of traffic can be marked for different kinds of forwarding. The DSCP bits are mapped to the Class of Service categories, and then into the output queues.

## **Domain Name Service (DNS)**

A system used for translating host names for network nodes into IP addresses.

## **Dynamic Host Control Protocol (DHCP)**

Provides a framework for passing configuration information to hosts on a TCP/IP network. DHCP is based on the Bootstrap Protocol (BOOTP), adding the capability of automatic allocation of reusable network addresses and additional configuration options.

## **DHCP Snooping**

A technique used to enhance network security by snooping on DHCP server messages to track the physical location of hosts, ensure that hosts only use the IP addresses assigned to them, and ensure that only authorized DHCP servers are accessible.

## **DHCP Option 82**

A relay option for sending information about the requesting client (or an intermediate relay agent) in the DHCP request packets forwarded by the switch and in reply

packets sent back from the DHCP server. This information can be used by DHCP servers to assign fixed IP addresses, or set other services or policies for clients.

### **Extensible Authentication Protocol over LAN (EAPOL)**

EAPOL is a client authentication protocol used by this switch to verify the network access rights for any device that is plugged into the switch. A user name and password is requested by the switch, and then passed to an authentication server (e.g., RADIUS) for verification. EAPOL is implemented as part of the IEEE 802.1X Port Authentication standard.

### **GARP VLAN Registration Protocol (GVRP)**

Defines a way for switches to exchange VLAN information in order to register necessary VLAN members on ports along the Spanning Tree so that VLANs defined in each switch can work automatically over a Spanning Tree network.

### **Generic Attribute Registration Protocol (GARP)**

GARP is a protocol that can be used by endstations and switches to register and propagate multicast group membership information in a switched environment so that multicast data frames are propagated only to those parts of a switched LAN containing registered endstations. Formerly called Group Address Registration Protocol.

### **Generic Multicast Registration Protocol (GMRP)**

GMRP allows network devices to register end stations with multicast groups. GMRP requires that any participating network devices or end stations comply with the IEEE 802.1p standard.

### **Group Attribute Registration Protocol (GARP)**

*See Generic Attribute Registration Protocol.*

### **IEEE 802.1D**

Specifies a general method for the operation of MAC bridges, including the Spanning Tree Protocol.

### **IEEE 802.1Q**

VLAN Tagging—Defines Ethernet frame tags which carry VLAN information. It allows switches to assign endstations to different virtual LANs, and defines a standard way for VLANs to communicate across switched networks.

### **IEEE 802.1p**

An IEEE standard for providing quality of service (QoS) in Ethernet networks. The standard uses packet tags that define up to eight traffic classes and allows switches to transmit packets based on the tagged priority value.



**IEEE 802.1s**

An IEEE standard for the Multiple Spanning Tree Protocol (MSTP) which provides independent spanning trees for VLAN groups.

**IEEE 802.1X**

Port Authentication controls access to the switch ports by requiring users to first enter a user ID and password for authentication.

**IEEE 802.3ac**

Defines frame extensions for VLAN tagging.

**IEEE 802.3af (PoE)**

An IEEE standard for providing Power over Ethernet (PoE) capabilities. When Ethernet is passed over copper cable, two twisted pairs are used for data transfer, and two twisted pairs are unused. With PoE, power can either be passed over the two data pairs or over the two spare pairs.

**IEEE 802.3x**

Defines Ethernet frame start/stop requests and timers used for flow control on full-duplex links. (Now incorporated in IEEE 802.3-2002)

**IGMP Query**

On each subnetwork, one IGMP-capable device will act as the querier — that is, the device that asks all hosts to report on the IP multicast groups they wish to join or to which they already belong. The elected querier will be the device with the lowest IP address in the subnetwork.

**IGMP Snooping**

Listening to IGMP Query and IGMP Report packets transferred between IP Multicast Routers and IP Multicast host groups to identify IP Multicast group members.

**Internet Group Management Protocol (IGMP)**

A protocol through which hosts can register with their local router for multicast services. If there is more than one multicast switch/router on a given subnetwork, one of the devices is made the “querier” and assumes responsibility for keeping track of group membership.

**In-Band Management**

Management of the network from a station attached directly to the network.

**IP Multicast Filtering**

A process whereby this switch can pass multicast traffic along to participating hosts.

## **Layer 2**

Data Link layer in the ISO 7-Layer Data Communications Protocol. This is related directly to the hardware interface for network devices and passes on traffic based on MAC addresses.

## **Link Aggregation**

*See Port Trunk.*

## **Link Aggregation Control Protocol (LACP)**

Allows ports to automatically negotiate a trunked link with LACP-configured ports on another device.

## **Link Layer Discovery Protocol (LLDP)**

LLDP is used to discover basic information about neighboring devices in the local broadcast domain by using periodic broadcasts to advertise information such as device identification, capabilities and configuration settings.

## **Management Information Base (MIB)**

An acronym for Management Information Base. It is a set of database objects that contains information about a specific device.

## **MD5 Message-Digest Algorithm**

An algorithm that is used to create digital signatures. It is intended for use with 32 bit machines and is safer than the MD4 algorithm, which has been broken. MD5 is a one-way hash function, meaning that it takes a message and converts it into a fixed string of digits, also called a message digest.

## **Multicast Switching**

A process whereby the switch filters incoming multicast frames for services for which no attached host has registered, or forwards them to all ports contained within the designated multicast VLAN group.

## **Multicast VLAN Registration**

A method of using a single network-wide multicast VLAN to transmit common services, such as such as television channels or video-on-demand, across a service-provider's network. MVR simplifies the configuration of multicast services by using a common VLAN for distribution, while still preserving security and data isolation for subscribers residing in both the MVR VLAN and other standard or private VLAN groups.

## **Multiple Spanning Tree Protocol (MSTP)**

MSTP can provide an independent spanning tree for different VLANs. It simplifies network management, provides for even faster convergence than RSTP by limiting

the size of each region, and prevents VLAN members from being segmented from the rest of the group.

### **Network Time Protocol (NTP)**

NTP provides the mechanisms to synchronize time across the network. The time servers operate in a hierarchical-master-slave configuration in order to synchronize local clocks within the subnet and to national time standards via wire or radio.

### **Out-of-Band Management**

Management of the network from a station not attached to the network.

### **Port Authentication**

*See IEEE 802.1X.*

### **Port Mirroring**

A method whereby data on a target port is mirrored to a monitor port for troubleshooting with a logic analyzer or RMON probe. This allows data on the target port to be studied unobstructively.

### **Port Trunk**

Defines a network link aggregation and trunking method which specifies how to create a single high-speed logical link that combines several lower-speed physical links.

### **Power over Ethernet**

The IEEE 802.3af standard for providing Power over Ethernet (PoE) capabilities. When Ethernet is passed over copper cable, two twisted pairs are used for data transfer, and two twisted pairs are unused. With PoE, power can either be passed over the two data pairs or over the two spare pairs.

### **Private VLANs**

Private VLANs provide port-based security and isolation between ports within the assigned VLAN. Data traffic on downlink ports can only be forwarded to, and from, uplink ports.

### **QinQ Tunneling**

QinQ is designed for service providers carrying traffic for multiple customers across their networks. It is used to maintain customer-specific VLAN and Layer 2 protocol configurations even when different customers use the same internal VLAN IDs.

### **Quality of Service (QoS)**

QoS refers to the capability of a network to provide better service to selected traffic flows using features such as data prioritization, queuing, congestion avoidance and

traffic shaping. These features effectively provide preferential treatment to specific flows either by raising the priority of one flow or limiting the priority of another flow.

### **Remote Authentication Dial-in User Service (RADIUS)**

RADIUS is a logon authentication protocol that uses software running on a central server to control access to RADIUS-compliant devices on the network.

### **Remote Monitoring (RMON)**

RMON provides comprehensive network monitoring capabilities. It eliminates the polling required in standard SNMP, and can set alarms on a variety of traffic conditions, including specific error types.

### **Rapid Spanning Tree Protocol (RSTP)**

RSTP reduces the convergence time for network topology changes to about 10% of that required by the older IEEE 802.1D STP standard.

### **Secure Shell (SSH)**

A secure replacement for remote access functions, including Telnet. SSH can authenticate users with a cryptographic key, and encrypt data connections between management clients and the switch.

### **Simple Mail Transfer Protocol (SMTP)**

A standard host-to-host mail transport protocol that operates over TCP, port 25.

### **Simple Network Management Protocol (SNMP)**

The application protocol in the Internet suite of protocols which offers network management services.

### **Simple Network Time Protocol (SNTP)**

SNTP allows a device to set its internal clock based on periodic updates from a Network Time Protocol (NTP) server. Updates can be requested from a specific NTP server, or can be received via broadcasts sent by NTP servers.

### **Spanning Tree Algorithm (STA)**

A technology that checks your network for any loops. A loop can often occur in complicated or backup linked network systems. Spanning Tree detects and directs data along the shortest available path, maximizing the performance and efficiency of the network.

### **Telnet**

Defines a remote communication facility for interfacing to a terminal device over TCP/IP.

**Terminal Access Controller Access Control System Plus (TACACS+)**

TACACS+ is a logon authentication protocol that uses software running on a central server to control access to TACACS-compliant devices on the network.

**Transmission Control Protocol/Internet Protocol (TCP/IP)**

Protocol suite that includes TCP as the primary transport protocol, and IP as the network layer protocol.

**Trivial File Transfer Protocol (TFTP)**

A TCP/IP protocol commonly used for software downloads.

**User Datagram Protocol (UDP)**

UDP provides a datagram mode for packet-switched communications. It uses IP as the underlying transport mechanism to provide access to IP-like services. UDP packets are delivered just like IP packets – connection-less datagrams that may be discarded before reaching their targets. UDP is useful when TCP would be too complex, too slow, or just unnecessary.

**Universal Time Coordinate (UTC)**

UTC is a time scale that couples Greenwich Mean Time (based solely on the Earth's rotation rate) with highly accurate atomic time. The UTC does not have daylight saving time.

**Virtual LAN (VLAN)**

A Virtual LAN is a collection of network nodes that share the same collision domain regardless of their physical location or connection point in the network. A VLAN serves as a logical workgroup with no physical barriers, and allows users to share information and resources as though located on the same LAN.

**XModem**

A protocol used to transfer files between devices. Data is grouped in 128-byte blocks and error-corrected.



**This page is intentionally left blank.**

# Index

---

## Numerics

- 802.1Q tunnel 3-196, 4-261
  - configuration, guidelines 3-199, 4-261
  - configuration, limitations 3-199
  - description 3-196
  - ethernet type 3-200, 4-263
  - interface configuration 3-200, 3-201, 4-262–4-263
  - mode selection 3-201, 4-262
  - status, configuring 3-200, 4-262
  - TPID 3-200, 4-263
  - uplink 3-201, 4-262
- 802.1X, port authentication 3-88, 4-136
- 802.1X, port authentication accounting 3-70, 4-119

---

## A

### AAA

- 802.1X port settings 3-70, 4-119
- accounting 3-65, 3-67, 4-114
- accounting exec command privileges 3-71, 4-120
- accounting summary 3-72, 4-122
- accounting updates 3-69, 4-119
- authorization method for CLI 3-75, 4-122
- authorization 3-65, 4-114
- authorization exec settings 3-75, 4-122
- authorization method for users 3-74, 4-121
- authorization summary 3-76, 4-122
- CLI command privileges 3-71, 4-120
- method name for out-of-band connections 3-72, 4-120
- RADIUS groups 3-66, 4-114
- TACACS+ groups 3-67, 4-114
- acceptable frame type 3-194, 4-255
- Access Control List See ACL
- ACL 3-108, 4-175
  - binding to an interface 3-115, 4-180

- Extended IP 3-109, 4-175, 4-178
- MAC 3-109, 4-181, 4-182–4-184
- Standard IP 3-109, 4-175, 4-177
- address table 3-158, 4-221
- aging time 3-160, 4-224
- authentication
  - MAC 3-107, 4-149
  - MAC address authentication 3-102, 4-149
  - MAC, configuring ports 3-107, 4-149
  - network access 3-102, 4-149
  - public key 3-81, 4-128
  - web 3-98, 4-157
  - web auth for ports, configuring 3-100, 4-160
  - web auth port info, displaying 3-101, 4-162
  - web auth, re-authenticating ports 3-101, 4-160
  - web, configuring 3-99, 4-157
- Authentication, Authorization, and Accounting See AAA

---

## B

- BOOTP 3-19, 4-345
- BPDU 3-161
- broadcast storm, threshold 3-145, 4-194

---

## C

- Class of Service See CoS
- CLI, showing commands 4-4
- clustering, multiple switches 3-269, 4-73
- command line interface See CLI
- community ports 3-204, 4-269
- community string 2-7, 3-42, 4-88
- community VLANs 3-206, 4-270
- configuration files, restoring defaults 3-23, 4-34
- configuration settings, saving or restoring 2-9, 3-23, 4-34, 4-35
- console port, required connections 2-2

**CoS**

- configuring 3-226, 4-306
  - DSCP 3-233, 4-311
  - layer 3/4 priorities 3-231, 4-311
  - queue mapping 3-228, 4-308
  - queue mode 3-230, 4-306
  - traffic class weights 3-230
- 

**D**

- debug commands 4-80
- default gateway, configuration 3-17, 4-346
- default priority, ingress port 3-226, 4-307
- default settings, system 1-6
- DHCP 3-19, 4-345
  - client 3-17, 4-345
  - dynamic configuration 2-5
  - snooping 3-116, 4-163
- DHCP snooping
  - enabling 3-117, 4-164
  - global configuration 3-117, 4-164
  - information option, enabling 3-119, 4-168
  - policy selection 3-119, 4-169
  - specifying trusted interfaces 3-120, 4-166
  - verifying MAC addresses 3-117, 4-167
- VLAN configuration 3-118, 4-165
- Differentiated Code Point Service *See* DSCP
- Differentiated Services *See* DiffServ
- DiffServ 3-235, 4-313
  - binding policy to interface 3-241, 4-320
  - class map 3-235, 4-314, 4-317
  - policy map 3-238, 4-316
  - service policy 3-241, 4-320
- downloading software 3-22, 4-35
- DSA encryption 3-82, 3-84, 4-132
- DSCP
  - enabling 3-232, 4-311
  - mapping priorities 3-233, 4-311
  - dynamic addresses, displaying 3-159, 4-223

- dynamic VLAN assignment 3-102, 3-104, 4-152
- 

**E**

- edge port, STA 3-173, 3-176, 4-238
  - encryption
    - DSA 3-82, 3-84, 4-132
    - RSA 3-82, 3-84, 4-132
  - engine ID 3-46, 4-93
  - event logging 3-29, 4-49
  - exec command privileges,
    - accounting 3-71, 4-120
  - exec settings, authorization 3-75, 4-122
- 

**F**

- filtering packets 3-108, 4-175
  - firmware
    - displaying version 3-14, 4-32
    - upgrading 3-22, 4-35
- 

**G**

- GARP VLAN Registration Protocol *See* GVRP
  - gateway, default 3-17, 4-346
  - general security measures 3-96, 4-147
  - GVRP
    - enabling 3-186, 4-249
    - global setting 3-186, 4-248, 4-249
    - interface configuration 3-194, 4-249
- 

**H**

- hardware version, displaying 3-14, 4-32
  - HTTPS 3-77, 3-78, 4-123, 4-124
    - configuring 3-77, 4-123
    - replacing SSL certificate 3-78
  - HTTPS, secure server 3-77, 4-123, 4-124
- 

**I**

- IEEE 802.1D 3-161, 4-227
- IEEE 802.1s 3-161, 4-227
- IEEE 802.1w 3-161, 4-227
- IEEE 802.1X 3-88, 4-136



**IGMP**

- filter profiles, configuration 3-258, 4-333
  - filtering, enabling 3-257
  - filtering/throttling 3-256, 4-332
  - filtering/throttling, configuring profile 4-334
  - filtering/throttling, creating profile 4-333
  - filtering/throttling, enabling 3-256, 4-333
  - filtering/throttling, interface settings 3-259, 4-335–4-336
  - groups, displaying 3-254, 4-326
  - immediate leave, status 3-251, 4-325
  - Layer 2 3-248, 4-322
  - query 3-248, 4-327
  - query, Layer 2 3-249, 4-327
  - snooping 3-248, 4-323
  - snooping & query, parameters 3-249
  - snooping, configuring 3-249, 4-322
- IGMP snooping**
- immediate leave 3-251, 4-325
  - leave proxy 4-324
- importing user public keys 3-84
- ingress filtering 3-194, 4-256
- IP address**
- BOOTP/DHCP 3-19, 4-345, 4-347
  - setting 2-4, 3-17, 4-345
- IP source guard** 3-123, 4-171
- configuring static entries 3-124, 4-173
  - setting filter criteria 3-123, 4-171

**J**

- jumbo frame 3-20, 4-33

**K****key**

- private 3-79, 4-127
- public 3-79, 4-127
- user public, importing 3-84

**key pair**

- host 3-79, 4-127

- host, generating 3-82, 4-132

**L****LACP**

- group attributes, configuring 3-139, 4-206
- group members, configuring 3-136, 4-204, 4-205, 4-207
- local parameters 3-141, 4-208
- partner parameters 3-143, 4-208
- protocol message statistics 3-140, 4-208

**Link Layer Discovery Protocol - Media Endpoint Discovery** See LLDP-MED**Link Layer Discovery Protocol** See LLDP**link type, STA** 3-173, 3-176, 4-240**LLDP** 3-212, 4-284

- device statistics detail, displaying 3-225, 4-305
- device statistics, displaying 3-223, 4-305
- display device information 3-220, 3-221, 4-303, 4-304
- displaying local information 3-218, 4-303
- displaying remote information 3-220, 4-304
- interface attributes, configuring 3-215, 4-290–4-298
- local device information, displaying 3-218, 4-303
- message attributes 3-215, 4-284, 4-290–4-298
- message statistics 3-223, 4-305
- message timing 3-213, 4-286–4-289
- remote information, displaying 3-221, 4-304
- remote port information, displaying 3-220, 4-304
- timing attributes, configuring 3-213, 4-286–4-289
- TLV 3-212, 3-215
- TLV, management address 3-215, 4-292

- TLV, port description 3-215, 4-292
- TLV, system capabilities 3-216, 4-293
- TLV, system description 3-215, 4-293
- TLV, system name 3-216, 4-294
- LLDP-MED 3-212
  - notification, status 3-216, 4-291
  - TLV 3-216
  - TLV, inventory 3-216, 4-299
  - TLV, location 3-216, 4-299
  - TLV, network policy 3-216, 4-300
  - TLV, PoE 3-216, 4-298
  - TLV, port capabilities 3-216, 4-300
- logging
  - syslog traps 3-30, 4-52
  - to syslog servers 3-30, 4-51
- log-in, Web interface 3-2
- logon authentication 3-57, 4-100
  - encryption key, configuring secret text string 3-64, 4-107, 4-111
  - RADIUS client 3-59, 4-105
  - RADIUS encryption key, configuring secret text string 3-64, 4-107
  - RADIUS server 3-59, 4-105
  - TACACS+ client 3-59, 4-109
  - TACACS+ encryption key, configuring secret text string 3-64, 4-111
  - TACACS+ server 3-59, 4-109
- logon authentication, sequence 3-60, 4-103, 4-104
- logon authentication, settings 3-60, 3-61, 4-103, 4-109
- loopback detection, STA 3-163, 4-241

---

## M

- MAC address authentication 3-102, 4-149
- MAC authentication 3-107, 4-149
  - ports, configuring 3-104, 3-107, 4-149
  - reauthentication 3-103, 4-154
- main menu 3-4, 4-9
- Management Information Bases (MIBs) A-3
- media-type 3-131, 4-192

Index-4

- mirror port, configuring 3-147, 4-218
- MSTP 3-177–3-182, 4-227
  - configuring 3-177, 4-232–4-235
  - global settings 3-177, 4-225
  - global settings, configuring 3-167, 4-227
  - global settings, displaying 3-164, 4-245
  - interface settings, configuring 3-174, 3-182, 4-243–4-244
  - interface settings, displaying 3-180, 4-245
- multicast filtering 3-247, 4-322
- multicast groups 3-254, 4-326
  - displaying 3-254, 4-326
  - static 3-254, 4-323, 4-326
- multicast services
  - configuring 3-255, 4-323
  - displaying 3-254, 4-326
- Multicast VLAN Registration See MVR
- multicast, filtering and throttling 3-256, 4-333
- multicast, static router port 3-253, 4-331
- MVR
  - assigning static multicast groups 3-267, 4-341
  - setting interface type 3-266, 4-341
  - setting multicast groups 3-262, 4-339
  - specifying a VLAN 3-262, 4-339
  - using immediate leave 3-266, 4-341

---

## N

- network access
  - authentication 3-102, 4-149
  - dynamic VLAN assignment 3-104, 4-152
  - port configuration 3-104, 4-151–4-156
  - reauthentication 3-103, 4-154
  - secure MAC information 3-106, 4-156

---

## P

- packet filtering 3-108, 4-175

password, changing privilege mode 4-102

password, line 4-42

passwords 2-4, 3-58  
 administrator setting 3-58, 4-101

path cost 3-164, 3-172  
 method 3-169, 4-231  
 STA 3-164, 3-172, 4-231

port authentication 3-88, 4-136

port power  
 displaying status 3-155, 4-216  
 inline 3-156, 4-214  
 inline status 3-155, 4-216  
 maximum allocation 3-155, 4-215  
 priority 3-157, 4-215  
 showing mainpower 3-155, 4-217

port priority  
 configuring 3-226, 4-306  
 default ingress 3-226, 4-307  
 STA 3-173, 4-237

port security, configuring 3-97, 4-148

port, statistics 3-149, 4-198

ports  
 autonegotiation 3-130, 4-189  
 broadcast storm threshold 3-145, 4-194  
 capabilities 3-130, 4-190  
 duplex mode 3-130, 4-188  
 flow control 3-130, 4-191  
 forced selection on combo ports 3-131, 4-192  
 Gigabit PHY Mode 3-130, 4-193  
 speed 3-130, 4-188

ports, configuring 3-127, 4-187

ports, mirroring 3-147, 4-218

power budgets  
 port 3-155, 4-215  
 port priority 3-157, 4-215

primary VLAN 3-205, 4-270

priority, default port ingress 3-226, 4-307

private key 3-79, 4-127

private VLANs, configuring 3-205, 3-206, 4-269

private VLANs, displaying 3-205, 4-260

problems, troubleshooting B-1

promiscuous ports 3-204, 4-269

protocol migration 3-176, 4-244

protocol VLANs 3-210, 4-275

public key 3-79, 4-127

PVLAN  
 association 3-207, 4-271  
 community ports 3-204, 4-269  
 configuring 3-205, 3-206  
 displaying 3-205, 4-260  
 interface configuration 3-208, 4-271–4-273  
 primary VLAN 3-205, 4-270  
 promiscuous ports 3-204, 4-269

---

## Q

QinQ Tunneling *See* 802.1Q

QoS 3-234, 4-313

Quality of Service *See* QoS

queue weights 3-230

---

## R

RADIUS  
 encryption key, configuring secret text string 3-64, 4-107

RADIUS, logon authentication 3-59, 4-105

RADIUS, settings 3-60, 4-105

rate limits, setting 3-148, 4-220

remote logging 3-30, 4-52

restarting the system 3-34, 4-13

restarting the system, time until reload 4-14

RSA encryption 3-82, 3-84, 4-132

RSTP 3-161, 4-227  
 global configuration 3-167, 4-227  
 global settings, configuring 3-167, 4-227  
 global settings, displaying 3-164, 4-245  
 interface settings, configuring 3-174, 4-235–4-242  
 interface settings, displaying 3-171, 4-245

---

**S**

- secure shell 3-79, 4-127
  - configuration 3-79, 4-127
- security, general measures 3-96, 4-147
- serial port, configuring 3-25, 4-40
- Simple Network Management Protocol
  - See SNMP
- SNMP 3-40, 4-86
  - community string 3-42, 4-88
  - enabling traps 3-43, 4-92
  - filtering IP addresses 3-94, 4-145
  - trap manager 3-43, 4-90
- SNMPv3 3-46, 4-93
  - engine ID 3-46, 3-47, 4-93
  - group configuration 3-52, 4-96
  - remote user configuration 3-50, 4-98
  - user configuration 3-48, 3-50, 4-98
  - views 3-55, 4-94
- software
  - displaying version 3-14, 4-32
  - downloading 3-22, 4-35
- Spanning Tree Protocol See STA
- specifications, software A-1
- SSH 3-79, 4-127
  - server, configuring 3-86, 4-129
- SSH, configuring 3-79, 4-127
- SSL, replacing certificate 3-78
- STA 3-161, 4-225
  - BPDU flooding 3-168, 3-175
  - edge port 3-173, 3-176, 4-238
  - global settings, configuring 3-167, 4-226–4-239
  - global settings, displaying 3-164, 4-245
  - interface settings 4-235–4-244
  - interface settings, configuring 3-174, 4-235–4-242
  - interface settings, displaying 3-171, 4-245
  - link type 3-173, 3-176, 4-240
  - loopback detection 3-163, 4-241
  - path cost 3-164, 3-172, 4-236
  - path cost method 3-169, 4-231
  - port priority 3-173, 4-237
  - port/trunk loopback detection 3-163, 4-241
  - protocol migration 3-176, 4-244
  - transmission limit 3-169, 4-231
- standards, IEEE A-2
- startup files
  - displaying 3-22, 4-27, 4-35
  - setting 3-22, 4-35, 4-39
- static addresses, setting 3-158, 4-221
- statistics, port 3-149, 4-198
- STP 3-167, 4-227
- STP *Also see* STA
- summary, accounting 3-72, 4-122
- switch clustering 3-269, 4-73
- switch settings
  - restoring 3-23, 4-34
  - saving 3-23, 4-34
- system clock, setting 3-35, 4-59
- system logs 3-29, 4-49
- system mode, normal or QinQ 3-200, 4-262
- system software, downloading from server 3-22, 4-35

---

**T**

- TACACS+
  - encryption key, configuring secret text string 3-64, 4-111
- TACACS+, logon authentication 3-59, 4-109
- TACACS+, settings 3-61, 4-109
- time, setting 3-35, 4-59
- TPID 3-200, 4-263
- traffic class weights 3-230
- traffic segmentation 3-202, 4-265
  - enabling 3-202, 4-265
  - sessions, creating 3-203, 4-266, 4-267
  - uplink-to-uplink, blocking 3-202, 4-268
  - uplink-to-uplink, forwarding 3-202, 4-268
- trap manager 2-7, 3-43, 4-90
- troubleshooting B-1
- trunk
  - configuration 3-132, 4-201
  - LACP 3-134, 4-203

static 3-133, 4-202  
Type Length Value *See also*  
LLDP-MED TLV  
Type Length Value *See* LLDP TLV

---

## U

upgrading software 3-22, 4-35  
UPnP 3-273, 4-78  
configuration 3-274, 4-77  
user account 3-58, 4-101  
user password 3-58, 4-101

---

## V

VLANs 3-183–3-212, 4-247–4-283  
802.1Q tunnel mode 3-200, 3-201,  
4-262  
adding static members 3-191,  
3-193, 4-258  
creating 3-189, 4-253  
description 3-183, 3-212  
displaying basic information 3-187,  
4-249  
displaying port members 3-188,  
4-260  
dynamic assignment 3-104, 4-152  
egress mode 3-195, 4-255  
interface configuration 3-194,  
4-255–4-259  
private 3-204, 4-269  
protocol 3-210, 4-274, 4-275  
protocol, binding to interfaces 3-211,  
4-275

protocol, configuring groups 3-210,  
4-275  
voice 3-242, 4-277  
voice VLAN 3-242, 4-277  
voice VLANs 3-242, 4-277  
detecting VoIP devices 3-242, 4-278  
enabling for ports 3-243, 4-280,  
4-280–4-282  
identifying client devices 3-245,  
4-279  
VoIP Traffic  
ports, configuring 3-243,  
4-280–4-282  
telephony OUI, configuring 3-245  
voice VLAN, configuring 3-242  
VoIP traffic 3-242, 4-277

---

## W

web authentication 3-98, 4-157  
configuring 3-99, 4-157  
enabling globally 3-99, 4-159  
enabling interface 3-100, 4-160  
port information, displaying 3-101,  
4-162  
ports, configuring 3-100, 4-160  
ports, re-authenticating 3-101,  
4-160  
Web interface  
access requirements 3-1  
configuration buttons 3-3  
home page 3-2  
menu list 3-4  
panel display 3-3





**This page is intentionally left blank.**

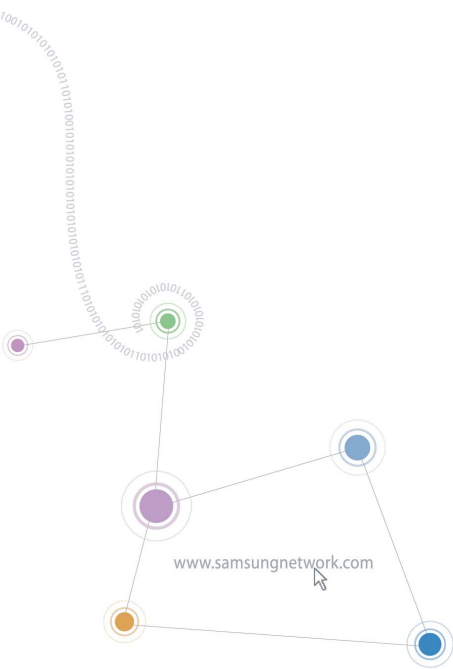

**This page is intentionally left blank.**

# iES4028F/4028FP Management Guide



Homepage   
[www.samsungnetwork.com](http://www.samsungnetwork.com)

Call Center   
1588-4141

