

EU Declaration of Conformity

SAMSUNG



We hereby declare that the product

Type of equipment : NETWORK CAMERA
Brand Name / Trade Mark : SAMSUNG
Model number : XNV-6080RP
Variant Model : -

satisfies all the technical regulations applicable to the product within the scope of Council Directives 2014/30/EU

EN 55022:2010 : Limits and methods of measurement of radio disturbance characteristics of information technology equipment
EN 50581:2012 : Technical documentation for the assessment of electrical and electronic products with respect to the restriction of hazardous substances
EN 50130-4:2011+A1:2014 : Product family standard: Immunity requirements for components of fire, intruder and social alarm systems
EN 61000-4-2:2009 : Electrostatic discharge immunity test
EN 61000-4-3:2006+A2:2010 : Radiated, radio-frequency, electromagnetic field immunity test
EN 61000-4-4:2012 : Electrical fast transient/burst immunity test
EN 61000-4-5:2014 : Surge immunity test
EN 61000-4-6:2014 : Immunity to conducted disturbances, induced by radio-frequency fields
EN 61000-4-11:2004 : Voltage dips, short interruptions and voltage variations immunity tests

All essential testing suites have been carried out.

Manufacturer : Hanwha Techwin (Tianjin) Co., Ltd.
Manufacturer address : No. 11 Weiliu Rd, Micro-Electronic Industrial Park, TEDA, Tianjin, 300385, People's Republic of China
Telephone / Fax : 82-02-729-2900 / 82-02-729-2904 (www.hanwhatechwin.com)
Applicant : Hanwha Techwin Co., Ltd.
Applicant address : 1204, Changwon-daero, Seongsan-gu, Chang-won-si, Gyeongsangnam-do, Korea

This declaration is issued under the sole responsibility of the manufacturer and his authorised representative.

Authorized signatory

Name / Title : Jei Soon, Kang / Principal Research Engineer
Date of issue : Dec. 23, 2016



KES Co., Ltd.

C-3701, Simin-daero 365-40,
Dongan-gu, Anyang-si, Gyeonggi-do, 14057, Korea
Tel: +82-31-425-6200 / Fax: +82-31-424-0450
www.kes.co.kr

Test report No.:
KES-E1-16T0673
Page (1) of (98)

EMC TEST REPORT For CE

Test Report No. : KES-E1-16T0673
Date of Issue : Dec, 23, 2016
Product name : NETWORK CAMERA
Model/Type No. : XNV-6080RP
Variant Model : -
Applicant : Hanwha Techwin Co., Ltd.
Applicant Address : 1204, Changwon-daero, Seongsan-gu, Changwon-si,
Gyeongsangnam-do, Korea
Manufacturer : Hanwha Techwin (Tianjin) Co.,Ltd.
Manufacturer Address : No.11 Weiliu Rd, Micro-Electronic Industrial
Park, TEDA, Tianjin, 300385, People's Republic of China
Date of Receipt : Nov, 23, 2016
Test date : Dec, 16, 2016 – Dec, 19, 2016
Test Results : **In Compliance** **Not in Compliance**

Tested by

Jin Bae, Lee
EMC Test Engineer

Reviewed by

Dong-Hun, Jang
EMC Technical Manager

This report shall not be reproduced except in full, without the written approval of KES Co., Ltd.
The results shown in this test report refer only to the sample(s) tested unless otherwise stated.



KES Co., Ltd.

C-3701, Simin-daero 365-40,
Dongan-gu, Anyang-si, Gyeonggi-do, 14057, Korea
Tel: +82-31-425-6200 / Fax: +82-31-424-0450
www.kes.co.kr

Test report No.:
KES-E1-16T0673
Page (2) of (98)

REPORT REVISION HISTORY

| Date | Test Report No. | Revision History |
|---------------|-----------------|------------------|
| Dec. 23, 2016 | KES-E1-16T0673 | Issued |
| | | |
| | | |
| | | |
| | | |
| | | |
| | | |
| | | |
| | | |
| | | |

This report shall not be reproduced except in full, without the written approval of KES Co., Ltd. This document Jun be altered or revised by KES Co., Ltd. personnel only, and shall be noted in the revision section of the document. Any alteration of this document not carried out by KES Co., Ltd. will constitute fraud and shall nullify the document.

This report shall not be reproduced except in full, without the written approval of KES Co., Ltd.
The results shown in this test report refer only to the sample(s) tested unless otherwise stated.



TABLE OF CONTENTS

| | | |
|---|---|----|
| 1.0 | General Product Description | 4 |
| 1.1 | Test Voltage & Frequency | 7 |
| 1.2 | Variant Model Differences..... | 7 |
| 1.3 | Device Modifications | 7 |
| 1.4 | Equipment Under Test..... | 7 |
| 1.5 | Support Equipments | 7 |
| 1.6 | External I/O Cabling..... | 8 |
| 1.7 | E.U.T Operating Mode(s) | 9 |
| 1.8 | Configuration..... | 10 |
| 1.9 | Calibration Details of Equipment Used for Measurement | 12 |
| 1.10 | Test Facility | 12 |
| 1.11 | Laboratory Accreditations and Listings | 12 |
| 2.0 | Test Regulations..... | 13 |
| 2.1 | Conducted Emissions at Mains Power Ports | 15 |
| 2.2 | Conducted Emissions at Telecommunication Ports | 16 |
| 2.3 | Radiated Electric Field Emissions(Below 1 GHz) | 17 |
| 2.4 | Radiated Electric Field Emissions(Above 1 GHz) | 18 |
| 2.5 | Harmonic Current Emissions | 19 |
| 2.6 | Voltage Fluctuations and Flicker | 20 |
| 3.0 | Criteria for compliance..... | 21 |
| 3.1 | Electrostatic Discharge..... | 23 |
| 3.2 | Radiated Electric Field Immunity | 27 |
| 3.3 | Electrical Fast Transients/Bursts | 30 |
| 3.4 | Surge Transients | 33 |
| 3.5 | Conducted Disturbance | 37 |
| 3.6 | Voltage Dips and Short Interruptions | 41 |
| APPENDIX A – TEST DATA..... | | 43 |
| Conducted Emissions at Mains Power Ports..... | | 43 |
| Conducted Emissions at Telecommunication Ports | | 45 |
| Radiated Electric Field Emissions(Below 1 GHz) | | 51 |
| Radiated Electric Field Emissions(Above 1 GHz) | | 53 |
| Harmonic Current Emissions and Voltage Fluctuations and Flicker | | 65 |
| Test Setup Photos and Configuration | | 68 |
| Conducted Voltage Emissions | | 68 |
| Conducted Telecommunication Emissions | | 69 |
| Radiated Electric Field Emissions(Below 1 GHz) | | 72 |
| Radiated Electric Field Emissions(Above 1 GHz) | | 75 |
| Harmonic Current Emissions and Voltage Fluctuations and Flicker | | 78 |
| Electrostatic Discharge | | 79 |
| Radiated Electric Field Immunity | | 81 |
| Electrical Fast Transients/Bursts..... | | 83 |
| Surge Transients..... | | 86 |
| Conducted Disturbance | | 88 |
| Voltage Dips and Short Interruptions..... | | 91 |
| EUT External Photographs | | 92 |
| EUT Internal Photographs | | 93 |

This report shall not be reproduced except in full, without the written approval of KES Co., Ltd.
The results shown in this test report refer only to the sample(s) tested unless otherwise stated.



1.0 General Product Description

Main Specifications of E.U.T are:

| | |
|-----------------------------|--|
| Video | |
| Imaging Device | 1/2.8" 2M CMOS |
| Total Pixels | 1945(H) x 1109(V) 2.16M |
| Effective Pixels | 1945(H) x 1097(V) 2.13M |
| Scanning System | Progressive Scan |
| Min. Illumination | Color : 0.03 lux(F1.4, 1./30sec) B/W : 0 Lux (F1.4, IR LED On) |
| S / N Ratio | 50dB |
| Video Out | CVBS : 1.0 Vp-p / 75Ω composite, 720x480(N), 720x576(P), for installation USB : Micro USB type B, 1920 x 1080, for installation |
| Lens | |
| Focal Length (Zoom Ratio) | 2.8~12mm(4.3x) motorized varifocal |
| Max. Aperture Ratio | 1.4(Wide) ~ 3.6(Tele) |
| Angular Field of View | H: 119.5°, V: 62.8°, D: 142.1° H: 27.9°, V: 15.7°, D: 32.0° |
| Min. Object Distance | 0.5m (1.64ft) |
| Focus Control | Simple focus(Motorized V/F) / Manual, Remote control via network(Manual, Simple focus) |
| Lens Type | DC Auto Iris, P-iris |
| Mount Type | Board-in type |
| Pan / Tilt / Rotate | |
| Pan / Tilt / Rotate range | 0° ~ 354° / 0° ~ 85°(TBD) / 0° ~ 355° |
| Operational | |
| IR-LED | 4EA |
| Viewable Length | (TBD)50m(164.04ft) |
| Camera Title | Off / On (Displayed up to 85 characters) - W/W : English/Numeric/Special Characters - China : English/Numeric/Special/Chinese Characters - Common : Multi-line (Max 5), Color (Grey/Green/Red/Blue/Black/White), Transparency, Auto Scale by Resolution |
| Day & Night | Auto (ICR) / Color / B/W / External / Schedule |
| Backlight Compensation | Off / BLC / HLC(Masking/Dimming), WDR |
| Wide Dynamic Range | 150dB |
| Contrast Enhancement | SSDR (Off / On) |
| Digital Noise Reduction | SSNR5 (2D+3D Noise Filter) (Off / On) |
| Digital Image Stabilization | Off / On |
| Defog | Auto(input from fog detection) / Manual / Off |
| Motion Detection | Off/ On(8ea, 8point Polygonal zones), Hand over |
| Privacy Masking | Off / On (32ea, polygonal zones) - Color : Grey/Green/Red/Blue/Black/White - Mosaic |
| Gain Control | Off / Low / Middle / High |
| White Balance | ATW / AWC / Manual / Indoor / Outdoor((included Mercury & Sodium) |
| Contrast | level adjustment |
| LDC | On/Off (5 levels with Min/Max) |
| Electronic Shutter Speed | Minimum / Maximum / Anti flicker (2 ~ 1/12,000sec →TBD) |
| Digital PTZ | 24X, 'Digital PTZ(Preset, Group) |

This report shall not be reproduced except in full, without the written approval of KES Co., Ltd.
The results shown in this test report refer only to the sample(s) tested unless otherwise stated.



KES Co., Ltd.

C-3701, Simin-daero 365-40,
 Dongan-gu, Anyang-si, Gyeonggi-do, 14057, Korea
 Tel: +82-31-425-6200 / Fax: +82-31-424-0450
 www.kes.co.kr

Test report No.:
 KES-E1-16T0673
 Page (5) of (98)

| | |
|--------------------------|---|
| Flip / Mirror | Flip : On/Off Mirror : On/Off Hallway view : 90°/270° |
| Video & Audio Analytics | Tampering, Loitering, Directional Detection, Defocus Detection, Fog Detection, Virtual Line, Enter/Exit, Appear / Disappear, Audio Detection, Motion Detection, Digital Auto Tracking, Sound Classification |
| Alarm I/O | Input 1ea / Output 1ea |
| Remote Control Interface | - |
| RS-485 Protocol | - |
| Alarm Triggers | Alarm Input, Motion Detection, Video & Audio Analytics, Network Disconnect |
| Alarm events | File upload via FTP, E-Mail Notification via E-Mail local storage(SD/SDHC/SDXC) or NAS recording at Event Triggers External output DPTZ preset |
| Audio In | Selectable (Mic IN/Line IN), Supply voltage: 2.5VDC(4mA), Input impedance: approx. 2K Ohm |
| Audio out | Line out, Max output level: 1 Vrms |
| Fan / Heater | N/A |
| Pixel Counter | Support |
| Network | |
| Ethernet | RJ-45 (10/100BASE-T) |
| Video Compression Form | H.265/H.264 (MPEG-4 Part 10/AVC) : Main/Baseline/High , Motion JPEG |
| Resolution | 1920x1080, 1280x1024, 1280x960, 1280x720, 1024x768, 800x600, 800x450, 720x576, 640x480, 640x360, 320x240, 320x180 |
| Max. Framerate | H.265/H.264 : Max. 60fps at all resolutions Motion JPEG : Max. 30fps |
| Smart Codec | Manual Mode (area-based : 5EA) |
| WiseStream | Support |
| Video Quality Adjustment | H.264/H.265 : Target Bitrate Level Control MJPEG : Target Bitrate Level Control |
| Bitrate Control Method | H.264/H.265 : CBR or VBR MJPEG : VBR |
| Streaming Capability | Multiple Streaming (Up to 10 Profiles) |
| Audio Compression Form | G.711 u-law /G.726 Selectable G.726 (ADPCM) 8KHz, G.711 8KHz G.726 : 16Kbps, 24Kbps, 32Kbps, 40Kbps AAC-LC : 48Kbps at 8/16/32/48KHz |
| Audio Communication | Bi-dierctional (2-Way) |
| IP | IPv4, IPv6 |
| Protocol | TCP/IP, UDP/IP, RTP(UDP), RTP(TCP), RTCP,RTSP, NTP, HTTP, HTTPS, SSL/TLS, DHCP, PPPoE, FTP, SMTP, ICMP, IGMP, SNMPv1/v2c/v3(MIB-2), ARP, DNS, DDNS, QoS, PIM-SM, UPnP, Bonjour |
| Security | HTTPS(SSL) Login Authentication Digest Login Authentication IP Address Filtering User access Log 802.1X Authentication (EAP-TLS, EAP-LEAP) |
| Streaming Method | Unicast / Multicast |

This report shall not be reproduced except in full, without the written approval of KES Co., Ltd.
 The results shown in this test report refer only to the sample(s) tested unless otherwise stated.



KES Co., Ltd.

C-3701, Simin-daero 365-40,
 Dongan-gu, Anyang-si, Gyeonggi-do, 14057, Korea
 Tel: +82-31-425-6200 / Fax: +82-31-424-0450
 www.kes.co.kr

Test report No.:
 KES-E1-16T0673
 Page (6) of (98)

| | |
|----------------------------------|---|
| Max. User Access | 20 users at Unicast Mode |
| Edge Storage | SD/SDHC/SDXC 2slot (up to 512 GB) - Continuous recording(1'st slot to 2'nd slot) - Motion Images recorded in the SD/SDHC/SDXC memory card can be downloaded. NAS(Network Attached Storage) Local PC for Instant Recording |
| Application Programming | ONVIF Profile S/G SUNAPI(HTTP API) Open Platform |
| Webpage Language | English, Korean, Chinese, French, Italian, Spanish, German, Japanese, Russian, Swedish, Danish, Portuguese, Czech, Polish, Turkish, Rumanian, Serbian, Dutch, Croatia, Hungary, Greek, Norsk, Finnish |
| Web Viewer | Supported OS: Windows 7, 8, 10, Mac OS X 10.10. 10.11 10.12 Non-plugin Webviewer Supported Browser: Google Chrome 54, MS Edge 38, Mozilla Firefox 49 , Apple Safari 9 (Mac OS X only) Plug-in Webviewer Supported Browser : MS Explore 11, Apple Safari 9 (Mac OS X only) |
| Central Management Soft | SmartViewer, SSM |
| Environmental | |
| Operating Temperature / Humidity | -40°C ~ +55°C (-40°F ~ +131°F) / Less than 90% RH |
| Storage Temperature / Humidity | -50°C ~ +60°C (-22°F ~ +140°F) / Less than 90% RH |
| Ingress Protection | IP67, IP66, NEMA 4X |
| Vandal Resistance | IK10 |
| Electrical | |
| Input Voltage / Current | 24VAC ± 10%, 12VDC ± 10%, PoE(IEEE802.3af) |
| Power Consumption | TBD |
| Mechanical | |
| Color / Material | Ivory / Aluminum |
| Dimension (WxHxD) | 기 SNV-6084R 사이즈 : (Ø 160 X H118.5) |
| Weight | 기 SNV-6084R 중량 : 975g (2.15 lb) |

This report shall not be reproduced except in full, without the written approval of KES Co., Ltd.
 The results shown in this test report refer only to the sample(s) tested unless otherwise stated.



1.1 Test Voltage & Frequency

Unless indicated otherwise on the individual data sheet or test results, the test voltage and frequency was as indicated below.

Voltage 220 Vac 230 Vac 24 Vac 12 Vdc PoE
Frequency 50 Hz 60 Hz Hz

1.2 Variant Model Differences

Not applicable

1.3 Device Modifications

Not applicable

1.4 Equipment Under Test

| Description | Model Number | Serial Number | Manufacturer | Remarks |
|----------------|--------------|---------------|------------------------------------|---------|
| NETWORK CAMERA | XNV-6080RP | - | Hanwha Techwin (Tianjin) Co., Ltd. | E.U.T |

1.5 Support Equipments

| Description | Model Number | Serial Number | Manufacturer | Remarks |
|------------------|---------------|------------------------|--------------------------------------|---------|
| POE Adapter | PD-3001GC/AC | RD9356082016964 200 | Power Dsine | - |
| Notebook | X56K | HN11N5151FJ0045 W | HANSUNG | - |
| Notebook Adapter | A12-120P1A | F180271552011758 | CHICONY POWER TECHNOLOGY CO.,LTD. | - |
| Phone | A1530 | - | APPLE | - |
| MIC | CMK-303 | - | CAMAC | 1.7 m |
| Speaker | BR10000A CUVE | - | BEIJING EDIFIER HI-TECH GROUP. | 1.6 m |
| Alarm | - | - | - | - |

1.6 External I/O Cabling

- AC 24 V Mode

| Start | | END | | Cable Spec. | |
|------------------------|----------|-------------|-----------|-------------|--------|
| Description | I/O Port | Description | I/O Port | Length | Shield |
| NETWORK CAMERA (E.U.T) | RJ-45 | Notebook | RJ-45 | 3.0 | U |
| | 7 Pin | MIC | 3.5 mm | 1.7 | U |
| | | Speaker | 3.5 mm | 1.6 | U |
| | | Alarm | 3 pin | 3.0 | U |
| Notebook | Audio in | Phone | Audio out | 1.7 | U |

- DC 12 V Mode

| Start | | END | | Cable Spec. | |
|------------------------|----------|-------------|-----------|-------------|--------|
| Description | I/O Port | Description | I/O Port | Length | Shield |
| NETWORK CAMERA (E.U.T) | RJ-45 | Notebook | RJ-45 | 3.0 | U |
| | 7 Pin | MIC | 3.5 mm | 1.7 | U |
| | | Speaker | 3.5 mm | 1.6 | U |
| | | Alarm | 3 pin | 3.0 | U |
| Notebook | Audio in | Phone | Audio out | 1.7 | U |

This report shall not be reproduced except in full, without the written approval of KES Co., Ltd.
 The results shown in this test report refer only to the sample(s) tested unless otherwise stated.

- PoE Mode

| Start | | END | | Cable Spec. | |
|------------------------|--------------|-------------|--------------|-------------|--------|
| Description | I/O Port | Description | I/O Port | Length | Shield |
| NETWORK CAMERA (E.U.T) | RJ-45 (POE) | POE Adapter | RJ-45 (POE) | 3.0 | U |
| | 7 Pin | MIC | 3.5 mm | 1.7 | U |
| | | Speaker | 3.5 mm | 1.6 | U |
| | | Alarm | 3 pin | 3.0 | U |
| Notebook | Audio in | Phone | Audio out | 1.7 | U |
| | RJ-45 (DATA) | POE Adapter | RJ-45 (DATA) | 3.0 | U |

* Unshielded=U, Shielded=S

1.7 E.U.T Operating Mode(s)

| operating |
|-------------------------------------|
| E.U.T Monitoring , Ping test, 1 kHz |

| E.U.T Test operating S/W | | |
|--------------------------|---------|--------------------------|
| Name | Version | Manufacture Company |
| SmartViewer | - | Hanwha Techwin Co., Ltd. |

- Input power condition during the measurements was 24 v (ac) , 12 v (dc) , PoE.

1.8 Configuration

■ AC 24 V Main
 □ DC 12 V Main

- AC 24 V Mode

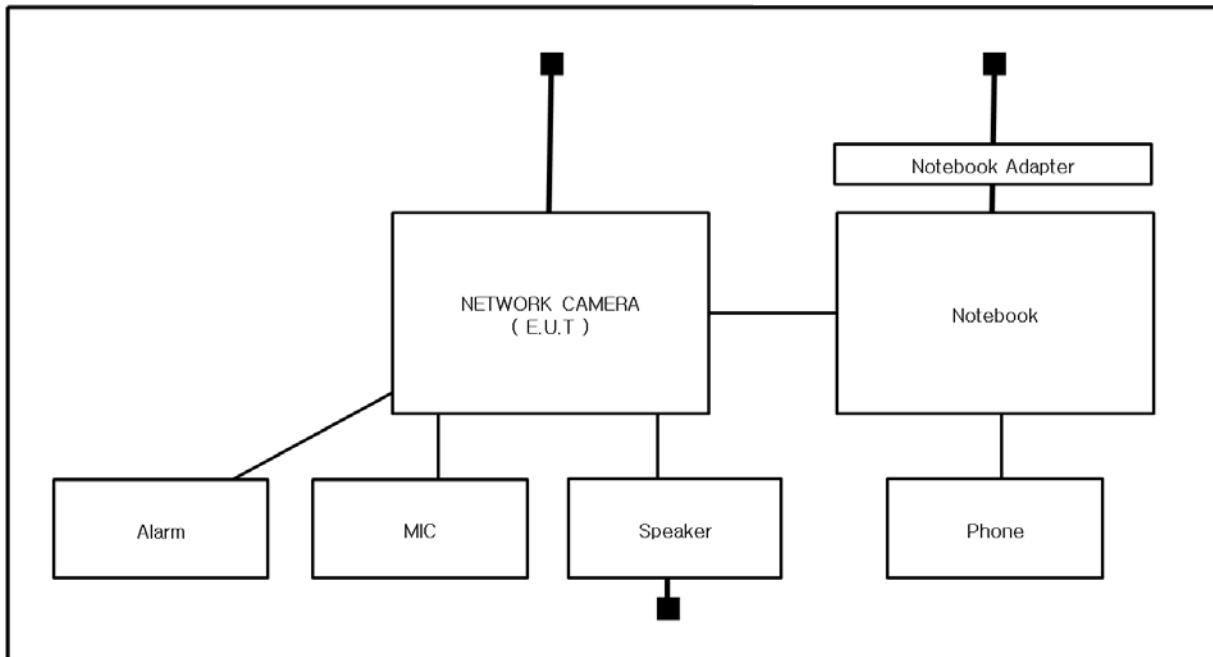

- DC 12 V Mode

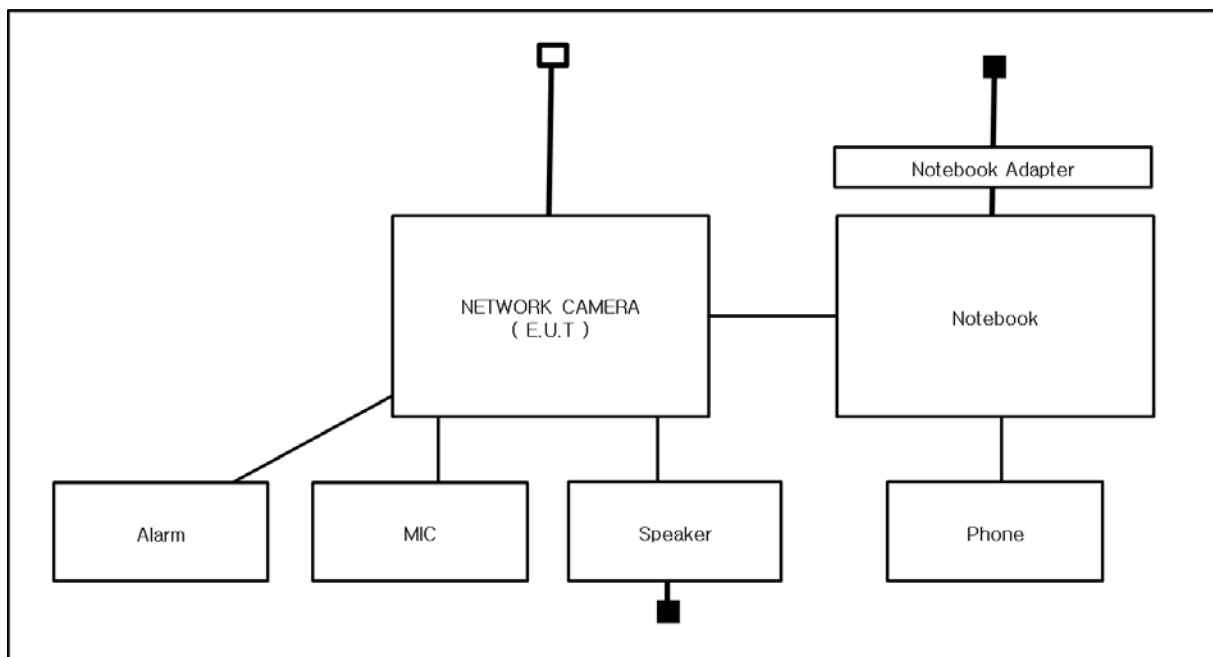

This report shall not be reproduced except in full, without the written approval of KES Co., Ltd.
 The results shown in this test report refer only to the sample(s) tested unless otherwise stated.

- PoE Mode

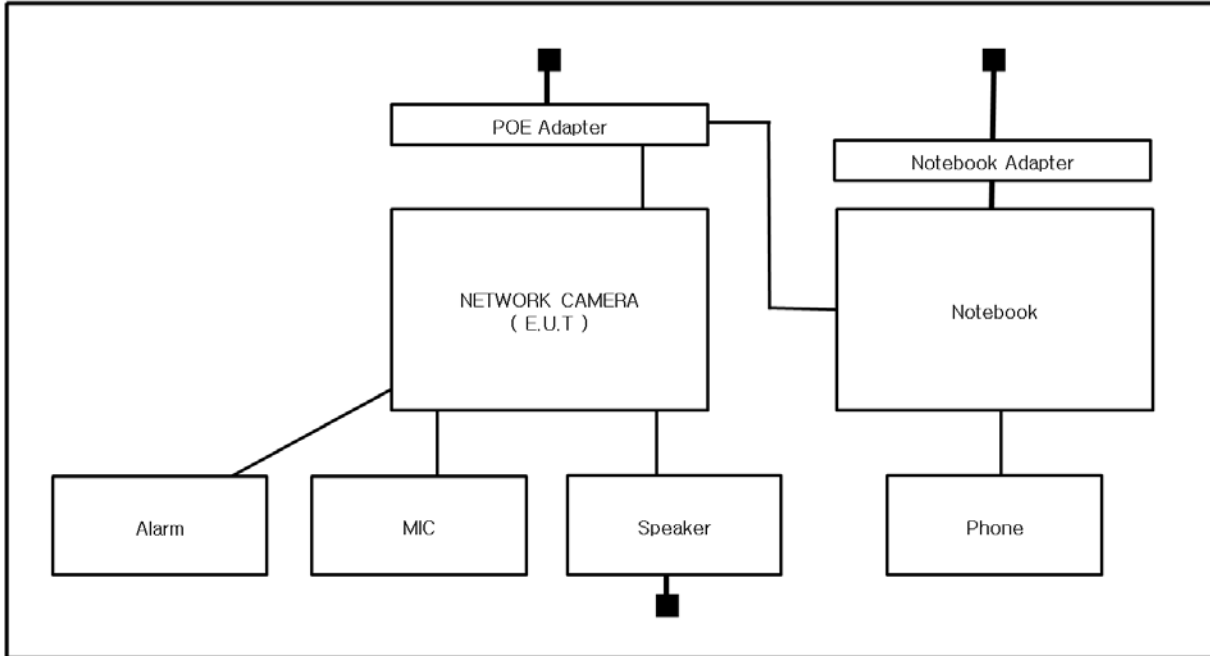

This report shall not be reproduced except in full, without the written approval of KES Co., Ltd.
The results shown in this test report refer only to the sample(s) tested unless otherwise stated.







1.9 Calibration Details of Equipment Used for Measurement

Test equipment and test accessories are calibrated on regular basis. The maximum time between calibrations is one year or what is recommended by the manufacturer, whichever is less.

1.10 Test Facility

The measurement facility is located at 473-21 Gayeo-ro, Yeosu-si, Gyeonggi-do, 12658, Korea. The sites are constructed in conformance with the requirements of ANSI C63.4 and CISPR Publication 22.

1.11 Laboratory Accreditations and Listings

| Country | Agency | Scope of Accreditation | Logo |
|---------------|--------|--|--|
| USA | FCC | 3 & 10 meter Open Area Test Sites and one conducted site to perform FCC Part 15/18 measurements. |  |
| JAPAN | VCCI | Mains Ports Conducted Interference Measurement, Telecommunication Ports Conducted Disturbance Measurement and Radiation 10 meter site, Facility for measuring radiated disturbance above 1 GHz |  R-4308, C-4798, T-2311, G-914 |
| KOREA | MSIP | EMI (10 meter Open Area Test Site and two conducted sites) Radio(3 & 10 meter Open Area Test Sites and one conducted site) EMS (ESD, RS, EFT/Burst, Surge, CS, Magnetic, Dips and interruptions) |  KR0100 |
| Canada | IC | 3 & 10 meter Open Area Test Sites and one conducted site |  4769B-1 |
| Europe | CE | EMI (10 meter Open Area Test Site and two conducted sites) Radio(3 & 10 meter Open Area Test Sites and one conducted site) EMS (ESD, RS, EFT/Burst, Surge, CS, Magnetic, Dips and interruptions) |  |
| International | KOLAS | EMI (10 meter Open Area Test Site and two conducted sites) Radio(3 & 10 meter Open Area Test Sites and one conducted site) EMS (ESD, RS, EFT/Burst, Surge, CS, Magnetic, Dips and interruptions) |  |

2.0 Test Regulations

The emissions tests were performed according to following regulations:

EMC – Directive 2014/30/EU

EN 61000-6-3:2011

EN 61000-6-1:2007

EN 61000-6-4:2007 +A1:2011

EN 61000-6-2:2005

EN 55011:2007 +A1:2010

Group 1
 Class A

Group 2
 Class B

EN 55014-1:2006 +A2:2011

EN 55014-2:1997 +A2:2008

EN 55015:2013

EN 61547:2009

EN 55022:2010

Class A

Class B

EN 55024:2010 +A1:2015

EN 50130-4:2011 +A1:2014

EN 61000-3-2:2014

EN 61000-3-3:2013

EN 61326-1:2013



KES Co., Ltd.

C-3701, Simin-daero 365-40,
Dongan-gu, Anyang-si, Gyeonggi-do, 14057, Korea
Tel: +82-31-425-6200 / Fax: +82-31-424-0450
www.kes.co.kr

Test report No.:
KES-E1-16T0673
Page (14) of (98)

-
- | | | |
|---|----------------------------------|----------------------------------|
| <input type="checkbox"/> VCCI V-3 / 2015.04 | <input type="checkbox"/> Class A | <input type="checkbox"/> Class B |
| <input type="checkbox"/> AS/NZS CISPR22:2009 +A1:2010 | <input type="checkbox"/> Class A | <input type="checkbox"/> Class B |
| <input type="checkbox"/> 47 CFR Part 15, Subpart B | | |
| <input type="checkbox"/> CISPR 22:2009 +A1:2010 | <input type="checkbox"/> Class A | <input type="checkbox"/> Class B |
| <input type="checkbox"/> ANSI C63.4-2009 | | |
| <input type="checkbox"/> IC Regulation ICES-003 : 2016 | | |
| <input type="checkbox"/> CAN/CSA CISPR 22-10 | <input type="checkbox"/> Class A | <input type="checkbox"/> Class B |
| <input type="checkbox"/> ANSI C63.4-2014 | | |
| <input type="checkbox"/> RE- Directive 2014/53/EU | | |
| <input type="checkbox"/> EN 301 489-1 V1.9.2 | | |
| <input type="checkbox"/> Equipment for fixed use | | |
| <input type="checkbox"/> Equipment for vehicular use | | |
| <input type="checkbox"/> Equipment for portable use | | |
| <input type="checkbox"/> EN 301 489-3 V1.6.1 | | |
| <input type="checkbox"/> EN 301 489-17 V2.2.1 | | |
| <input type="checkbox"/> EN 60945:2002 | | |

This report shall not be reproduced except in full, without the written approval of KES Co., Ltd.
The results shown in this test report refer only to the sample(s) tested unless otherwise stated.

2.1 Conducted Emissions at Mains Power Ports

Test Date

Dec, 16, 2016

Test Location

Electro wave Shieldroom

Test Equipment

| Used | Description | Model Number | Manufacturer | Serial Number | Cal. Due |
|-------------------------------------|-------------------------|--------------|--------------|---------------|--------------|
| <input checked="" type="checkbox"/> | EMI Test Receiver | ESR3 | R & S | 101783 | 05, 03, 2017 |
| <input checked="" type="checkbox"/> | LISN | ENV216 | R & S | 101137 | 02, 04, 2017 |
| <input checked="" type="checkbox"/> | LISN | ENV216 | R & S | 101786 | 05, 02, 2017 |
| <input checked="" type="checkbox"/> | Electro wave Shieldroom | - | SEMITEC | - | - |
| <input checked="" type="checkbox"/> | EMI Test S/W | EMC32 | R&S | 9.12.00 | - |

Test Conditions

Temperature: 19,5 °C
Relative Humidity: 36,5 %

Frequency Range of Measurement

150 kHz to 30 MHz

Instrument Settings

IF Band Width: 9 kHz

Test Results

The requirements are:

- PASS
 NOT PASS
 NOT APPLICABLE

Remarks

See Appendix A for test data.

DC 12 V , PoE Mode N/A : E.U.T Power is 12 v(dc) power and PoE, limits are not specified.

2.2 Conducted Emissions at Telecommunication Ports

Test Date

Dec, 16, 2016

Test Location

Electro wave Shieldroom

Test Equipment

| Used | Description | Model Number | Manufacturer | Serial Number | Cal. Due |
|-------------------------------------|-------------------------|--------------|------------------|---------------|--------------|
| <input checked="" type="checkbox"/> | EMI Test Receiver | ESR3 | R&S | 101783 | 05, 03, 2017 |
| <input checked="" type="checkbox"/> | LISN | ENV216 | R&S | 101137 | 02, 04, 2017 |
| <input checked="" type="checkbox"/> | LISN | ENV216 | R&S | 101786 | 05, 02, 2017 |
| <input checked="" type="checkbox"/> | 8-Wire ISN CAT3 | CAT3 8158 | Schwarzbeck Mess | 8158-0019 | 04, 01, 2017 |
| <input checked="" type="checkbox"/> | 8-Wire ISN CAT5 | CAT5 8158 | Schwarzbeck Mess | 8158-0030 | 04, 01, 2017 |
| <input type="checkbox"/> | 8-Wire ISN CAT6 | NTFM 8158 | Schwarzbeck Mess | 8158-0029 | 08, 11, 2017 |
| <input checked="" type="checkbox"/> | Electro wave Shieldroom | - | SEMITEC | - | - |
| <input checked="" type="checkbox"/> | EMI Test S/W | EMC32 | R&S | 9.12.00 | - |

Test Conditions

Temperature: 19,5 °C

Relative Humidity: 36,5 %

Frequency Range of Measurement

150 kHz to 30 MHz

Instrument Settings

IF Band Width: 9 kHz

Test Results

The requirements are:

- PASS
- NOT PASS
- NOT APPLICABLE

Remarks

See Appendix A for test data.

2.3 Radiated Electric Field Emissions(Below 1 GHz)

Test Date

Dec, 16, 2016

Test Location

Open Area Test Site #1 Open Area Test Site #2

Test Equipment

| Used | Description | Model Number | Manufacturer | Serial Number | Cal. Due |
|-------------------------------------|----------------------|--------------|--------------|---------------|--------------|
| <input checked="" type="checkbox"/> | EMI TEST Receiver | ESR3 | R&S | 101781 | 05, 03, 2017 |
| <input checked="" type="checkbox"/> | Trilog-Broadband ANT | VULB 9163 | Schwarzbeck | 9163-713 | 05, 15, 2017 |
| <input checked="" type="checkbox"/> | Open Area Test Site | - | KES | - | - |
| <input checked="" type="checkbox"/> | Antenna Mast | - | DAEIL EMC | - | - |
| <input checked="" type="checkbox"/> | Turn Table | - | DAEIL EMC | - | - |
| <input checked="" type="checkbox"/> | EMI Test S/W | - | - | - | - |

Test Conditions

Temperature: -1,0 °C
 Relative Humidity: 38,0 %

Frequency Range of Measurement

30 MHz to 1 GHz

Instrument Settings

IF Band Width: 120 kHz

Test Results

The requirements are:

- PASS
 NOT PASS
 NOT APPLICABLE

Remarks

See Appendix A for test data.

2.4 Radiated Electric Field Emissions(Above 1 GHz)

Test Date

Dec, 16, 2016

Test Location

Semi Anechoic Chamber #2

Test Equipment

| Used | Description | Model Number | Manufacturer | Serial Number | Cal. Due |
|-------------------------------------|--------------------------------|--------------|-------------------------------|---------------|--------------|
| <input checked="" type="checkbox"/> | DOUBLE RIDGED HORN ANTENNA | SAS-571 | A.H.SYSTEM,INC | 781 | 05, 07, 2017 |
| <input checked="" type="checkbox"/> | EMI Test Receiver | ESU26 | R&S | 100552 | 04, 24, 2017 |
| <input checked="" type="checkbox"/> | Broadband Coaxial Preamplifier | BBV 9718 | Schwarzbeck Mess - Elektronik | 9718-246 | 10, 14, 2017 |
| <input checked="" type="checkbox"/> | Semi Anachoic Chamber #2 | - | SEMITEC | - | - |
| <input checked="" type="checkbox"/> | Antenna Mast | - | AUDIX | - | - |
| <input checked="" type="checkbox"/> | Turn Table | - | AUDIX | - | - |
| <input checked="" type="checkbox"/> | EMI Test S/W | e3 | AUDIX | 8.083b | - |

Test Conditions

Temperature: 19,5 °C

Relative Humidity: 36,5 %

Frequency Range of Measurement

1 GHz to 6 GHz

Instrument Settings

IF Band Width: 1 MHz

Test Results

The requirements are:

- PASS
- NOT PASS
- NOT APPLICABLE

Remarks

See Appendix A for test data.



2.5 Harmonic Current Emissions

Test Date

N/A

Test Location

Electro wave Shieldroom

Test Equipment

| Used | Description | Model Number | Manufacturer | Serial Number | Cal. Due |
|--------------------------|------------------------|--------------|--------------|---------------|--------------|
| <input type="checkbox"/> | AC Source | ACS 500 N | EM TEST | V1024106760 | 08, 08, 2017 |
| <input type="checkbox"/> | Digital Power Analyzer | DPA 500 N | EM TEST | V1024106759 | 08, 08, 2017 |
| <input type="checkbox"/> | EMI Test S/W | dpa.control | EM TEST AG | 5.4.8.0 | - |

Test Conditions

Temperature: °C

Relative Humidity: %

Classification of Equipment for Harmonic Current Emissions

- Class A
- Class B
- Class C(Below 25 W)
- Class C(Above 25 W)
- Class D

Test Results

The requirements are:

- PASS
- NOT PASS
- NOT APPLICABLE

Remarks

N/A : Because the E.U.T power is less than 75 W, limits are not specified.



2.6 Voltage Fluctuations and Flicker

Test Date

N/A

Test Location

Electro wave Shieldroom

Test Equipment

| Used | Description | Model Number | Manufacturer | Serial Number | Cal. Due |
|--------------------------|------------------------|--------------|--------------|---------------|--------------|
| <input type="checkbox"/> | AC Source | ACS 500 N | EM test | V1024106760 | 08, 08, 2017 |
| <input type="checkbox"/> | Digital Power Analyzer | DPA 500 N | EM test | V1024106759 | 08, 08, 2017 |
| <input type="checkbox"/> | EMI Test S/W | dpa.control | EM TEST AG | 5.4.8.0 | - |

Test Conditions

Temperature: °C
Relative Humidity: %

Test Results

The requirements are:

- PASS
- NOT PASS
- NOT APPLICABLE

Remarks

N/A

3.0 Criteria for compliance

Criteria for compliance was based on the following guidelines:
EN 50130-4:2011 +A1:2014 Alarm systems-Part 4: Electromagnetic compatibility Product family standard: Immunity requirements for components of fire, intruder and social alarm systems

The variety and the diversity of the apparatus within the scope of this document makes it difficult to define precise criteria for the evaluation of the immunity test results.

If as a result of the application of the tests defined in this standard, the apparatus becomes dangerous or unsafe then the apparatus shall be deemed to have failed the test.

A functional description and a definition of performance by the manufacture and noted in the test report, based on the following criteria:

Electrostatic discharge

There shall be no damage, malfunction or change of status due to the conditioning.
Flickering of an indicator during the application of discharge is permissible, providing that is no residual change in the EUT or any change in outputs, which could be interpreted by associated equipment as a change.

Radiated electromagnetic fields

There shall be no damage, malfunction or change of status due to the conditioning.
Flickering of an indicator during the application of discharge is permissible, providing which could be interpreted by associated equipment as a change, and no such
Flickering of indicators occurs at a field strength of 3 V/m.
For components of CCTV systems, where the picture is allowed at 10 V/m, providing.
(a) there is no permanent damage or change to EUT
(e.g. no corruption of memory or changes to programmable setting etc.)
(b) at 3 V/m, any deterioration of the picture is so minor that the system could still be used; and
(c) there is no observable deterioration of the picture at 1 V/m.

Fast transient burst / slow high energy voltage surge

There shall be no damage, malfunction or change of status due to the conditioning.

Flickering of an indicator during the application of discharge is permissible, providing

That there is no residual is permissible, providing that there is no residual change in the EUT or any change in outputs, which could be interpreted by associated equipment as a change.

Conducted RF immunity

There shall be no damage, malfunction or change of status due to the conditioning.

Flickering of an indicator during the application of discharge is permissible, providing

That there is no residual is permissible, providing that there is no residual change in the EUT or any change in outputs, which could be interpreted by associated equipment as a change, and no such flickering of indicators oeuvres at $U = 130 \text{ dB}\mu\text{V}$.

For component of CCTV systems, where the status is monitored by observing the TV picture, then deterioration of the picture is allowed at $U = 140 \text{ dB}\mu\text{V}$, providing:

(a) there is no permanent damage or change to the EUT

(e.g. no corruption of memory or changes to programmable settings etc.)

(b) at $U = 130 \text{ dB}\mu\text{V}$, any deterioration of the picture is so minor that the system could still be used; and

(c) there in no observable deterioration of the picture at $U = 120 \text{ dB}\mu\text{V}$.

Voltage dip/interruption / Voltage variation

There shall be no damage, malfunction or change of status due to the conditioning.

Flickering of an indicator during the conditioning is permissible, providing that there is no residual change in the EUT or any change in outputs, which could be interpreted by associated equipment

as a change. The EUT shall meet the acceptance criteria for the functional test, after the conditioning.

3.1 Electrostatic Discharge

Reference Standard

EN 61000-4-2: 2009

Test Date

Dec, 17, 2016

Test Location

EMS-ESD: Electro wave Shieldroom

Test Equipment

| Used | Description | Model Number | Manufacturer | Serial Number | Cal. Due |
|-------------------------------------|---------------|--------------|--------------|---------------|--------------|
| <input checked="" type="checkbox"/> | ESD SIMULATOR | ESS-2000 | Noise Ken | ESS05X4620 | 02, 24, 2017 |
| <input checked="" type="checkbox"/> | HCP | - | Noise Ken | - | - |
| <input checked="" type="checkbox"/> | VCP | - | Noise Ken | - | - |
| <input checked="" type="checkbox"/> | EMS Test S/W | N/A | N/A | N/A | - |

Test Conditions

Temperature: 18,8 °C
Relative Humidity: 39,4 %
Atmospheric Pressure: 101,6 kPa

Test Specifications

Discharge Factor: ≥ 1 s

Discharge Impedance: 330 ohm / 150 pF

Kind of Discharge: Air, Contact (direct and indirect)

Polarity: Positive and Negative

Number of Discharge: 10 at all locations for Air discharge
10 at all locations for Contact discharge

| | | | | |
|--------------------|--|--|--|--|
| Discharge Voltage: | Contact | Air | HCP | VCP |
| | <input type="checkbox"/> 2 kV | <input checked="" type="checkbox"/> 2 kV | <input type="checkbox"/> 2 kV | <input type="checkbox"/> 2 kV |
| | <input type="checkbox"/> 4 kV | <input checked="" type="checkbox"/> 4 kV | <input type="checkbox"/> 4 kV | <input type="checkbox"/> 4 kV |
| | <input checked="" type="checkbox"/> 6 kV | <input type="checkbox"/> 6 kV | <input checked="" type="checkbox"/> 6 kV | <input checked="" type="checkbox"/> 6 kV |
| | <input type="checkbox"/> 8 kV | <input checked="" type="checkbox"/> 8 kV | <input type="checkbox"/> 8 kV | <input type="checkbox"/> 8 kV |
| | <input type="checkbox"/> 15 kV | <input type="checkbox"/> 15 kV | <input type="checkbox"/> 15 kV | <input type="checkbox"/> 15 kV |

Notes: HCP: Horizontal coupling plane
VCP: Vertical coupling plane

Required Performance Criteria: Complied

This report shall not be reproduced except in full, without the written approval of KES Co., Ltd.
The results shown in this test report refer only to the sample(s) tested unless otherwise stated.

Location of Discharge:

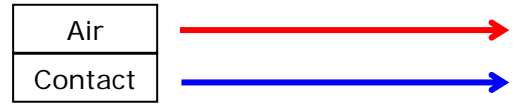

This report shall not be reproduced except in full, without the written approval of KES Co., Ltd.
The results shown in this test report refer only to the sample(s) tested unless otherwise stated.



Test Data

- AC 24 V Mode

Indirect Discharge

| No. | Test Point | Discharge Method | Observations | Remarks |
|-----|-------------|-------------------|--------------|---------|
| 1 | HCP Contact | Contact Discharge | Complied | - |
| 2 | VCP Contact | Contact Discharge | Complied | - |

Direct Discharge

| No. | Test Point | Discharge Method | Observations | Remarks |
|-----|------------|-------------------|--------------|---------|
| 1 | Screw | Contact Discharge | Complied | - |

- DC 12 V Mode

Indirect Discharge

| No. | Test Point | Discharge Method | Observations | Remarks |
|-----|-------------|-------------------|--------------|---------|
| 1 | HCP Contact | Contact Discharge | Complied | - |
| 2 | VCP Contact | Contact Discharge | Complied | - |

Direct Discharge

| No. | Test Point | Discharge Method | Observations | Remarks |
|-----|------------|-------------------|--------------|---------|
| 1 | Screw | Contact Discharge | Complied | - |



- PoE Mode

Indirect Discharge

| No. | Test Point | Discharge Method | Observations | Remarks |
|-----|-------------|-------------------|--------------|---------|
| 1 | HCP Contact | Contact Discharge | Complied | - |
| 2 | VCP Contact | Contact Discharge | Complied | - |

Direct Discharge

| No. | Test Point | Discharge Method | Observations | Remarks |
|-----|------------|-------------------|--------------|---------|
| 1 | Screw | Contact Discharge | Complied | - |

Note: "Blank" = Not performed

Observations:

Complied – No degradation of function

Test Results

- PASS Required Performance Criteria
- NOT PASS Required Performance Criteria

Remarks

PASS Required Performance Criteria.

3.2 Radiated Electric Field Immunity

Reference Standard

EN 61000-4-3:2006 +A2:2010

Test Date

Dec, 17, 2016

Test Location

EMS-RS: Semi Anechoic Chamber #1 Semi Anechoic Chamber #2

Test Equipment

| Used | Description | Model Number | Manufacturer | Serial Number | Cal. Due |
|-------------------------------------|---------------------------------|---------------------|-------------------------------------|---------------|--------------|
| <input checked="" type="checkbox"/> | Signal Generator | ESG-3000A | HP | US37040210 | 11, 01, 2017 |
| <input checked="" type="checkbox"/> | Amplifier | ITA0300-200 | Infinitech | - | 11, 01, 2017 |
| <input checked="" type="checkbox"/> | Amplifier | ITA0750-200 | Infinitech | - | 11, 01, 2017 |
| <input checked="" type="checkbox"/> | Amplifier | ITA1500-100 | Infinitech | - | 11, 01, 2017 |
| <input checked="" type="checkbox"/> | Amplifier | ITA2500-100 | Infinitech | - | 11, 01, 2017 |
| <input checked="" type="checkbox"/> | GPIB INTERFACE CONTROL | SYSTEM CONTROL UNIT | Infinitech | - | - |
| <input checked="" type="checkbox"/> | POWER SUPPLY | SYSTEM POWER SUPPLY | Infinitech | - | - |
| <input checked="" type="checkbox"/> | Power Meter | E4419B | Agilent | MY45101506 | 06, 27, 2017 |
| <input checked="" type="checkbox"/> | Average Power Sensor | E9301A | Agilent | - | 06, 27, 2017 |
| <input checked="" type="checkbox"/> | Average Power Sensor | E9301A | Agilent | MY41495698 | 11, 17, 2017 |
| <input checked="" type="checkbox"/> | Stacked Double Log-Per- Antenna | STPL9128 D | SCHWARZBECK | 9128D038 | - |
| <input checked="" type="checkbox"/> | Semi Anechoic Chamber #2 | - | SEMITEC | - | 11, 08, 2017 |
| <input checked="" type="checkbox"/> | EMS Test S/W | KTI_RS2012 | KOREA TECHNOLOGY INSTITUTE CO., LTD | 2.1.1 | - |

This report shall not be reproduced except in full, without the written approval of KES Co., Ltd.
The results shown in this test report refer only to the sample(s) tested unless otherwise stated.



KES Co., Ltd.

C-3701, Simin-daero 365-40,
Dongan-gu, Anyang-si, Gyeonggi-do, 14057, Korea
Tel: +82-31-425-6200 / Fax: +82-31-424-0450
www.kes.co.kr

Test report No.:
KES-E1-16T0673
Page (28) of (98)

Test Conditions

Temperature: 18,8 °C
Relative Humidity: 39,4 %
Atmospheric Pressure: 101,6 kPa

Test Specifications

Antenna Polarization: Horizontal & vertical unless indicated otherwise

Antenna Distance: 3 m

Field Strength: 1 V/m 3 V/m
 10 V/m

Frequency Range: 80 MHz to 1 GHz 1,4 GHz to 2,7 GHz
 80 MHz to 2,7 GHz

Modulation: AM, 80 %, 1 kHz sine wave
 PM, 1 Hz (0,5 s ON : 0,5 s OFF)

Frequency step: 1 % step

Dwell Time: 1 s 3 s

of Sides Radiated: 4

Required Performance Criteria: Complied

This report shall not be reproduced except in full, without the written approval of KES Co., Ltd.
The results shown in this test report refer only to the sample(s) tested unless otherwise stated.



Test Data

- AC 24 V Mode

| Side Exposed | Observations | |
|--------------|--------------|----------|
| | Horizontal | Vertical |
| Front | Complied | Complied |
| Right | Complied | Complied |
| Back | Complied | Complied |
| Left | Complied | Complied |

- DC 12 V Mode

| Side Exposed | Observations | |
|--------------|--------------|----------|
| | Horizontal | Vertical |
| Front | Complied | Complied |
| Right | Complied | Complied |
| Back | Complied | Complied |
| Left | Complied | Complied |

- PoE Mode

| Side Exposed | Observations | |
|--------------|--------------|----------|
| | Horizontal | Vertical |
| Front | Complied | Complied |
| Right | Complied | Complied |
| Back | Complied | Complied |
| Left | Complied | Complied |

Note: "Blank" = Not performed

Observations:

Complied – No degradation of function

Test Results

- PASS Required Performance Criteria
- NOT PASS Required Performance Criteria

Remarks

PASS Required Performance Criteria.

3.3 Electrical Fast Transients/Bursts

Reference Standard

EN 61000-4-4:2012

Test Date

Dec, 19, 2016

Test Location

EMS-EFT: Electro wave Shieldroom

Test Equipment

| Used | Description | Model Number | Manufacturer | Serial Number | Cal. Due |
|-------------------------------------|---------------------------|--------------|--------------|---------------|--------------|
| <input checked="" type="checkbox"/> | Ultra Compact Simulator | UCS 500 N5 | EM TEST | V0936105120 | 06, 27, 2017 |
| <input checked="" type="checkbox"/> | Capacitive Coupling Clamp | HFK | EM TEST | 070925 | 06, 27, 2017 |
| <input checked="" type="checkbox"/> | Motor Variac | MV2616 | EM TEST | V0936105123 | 06, 27, 2017 |
| <input checked="" type="checkbox"/> | EMS Test S/W | iec.control | EM TEST AG | 5.0.9.0 | - |

Test Conditions

Temperature: 19,2 °C
Relative Humidity: 38,5 %
Atmospheric Pressure: 101,0 kPa

Test Specifications

Pulse Amplitude & Polarity:
(AC,DC Power Lines) ± 1.0 kV ± 2.0 kV
 ± 4.0 kV

Pulse Amplitude & Polarity:
(Other supply / Signal Lines) ± 0.5 kV ± 1.0 kV
 ± 2.0 kV

Burst Period: 300 ms 2 s

Repetition Rate: 5 kHz 100 kHz

Duration of Test Voltage: ≥ 1 min

Required Performance Criteria: Complied

This report shall not be reproduced except in full, without the written approval of KES Co., Ltd.
The results shown in this test report refer only to the sample(s) tested unless otherwise stated.

Test Data

- AC 24 V Mode

Input a.c. power ports – Coupling/Decoupling Network used

| Mode of Application | Observations | |
|---------------------|----------------|----------------|
| | (+) Burst (kV) | (-) Burst (kV) |
| L – N | Complied | Complied |

Input d.c. power ports – Coupling/Decoupling Network used

| Mode of Application | Observations | |
|---------------------|----------------|----------------|
| | (+) Burst (kV) | (-) Burst (kV) |
| - | - | - |

Signal ports and telecommunication ports – Coupling Clamp used

| Mode of Application | Observations | |
|---------------------|----------------|----------------|
| | (+) Burst (kV) | (-) Burst (kV) |
| RJ-45 | Complied | Complied |
| Alarm | Complied | Complied |

- DC 12 V Mode

Input a.c. power ports – Coupling/Decoupling Network used

| Mode of Application | Observations | |
|---------------------|----------------|----------------|
| | (+) Burst (kV) | (-) Burst (kV) |
| - | - | - |

Input d.c. power ports – Coupling/Decoupling Network used

| Mode of Application | Observations | |
|---------------------|----------------|----------------|
| | (+) Burst (kV) | (-) Burst (kV) |
| L1 – L2 | Complied | Complied |

Signal ports and telecommunication ports – Coupling Clamp used

| Mode of Application | Observations | |
|---------------------|----------------|----------------|
| | (+) Burst (kV) | (-) Burst (kV) |
| RJ-45 | Complied | Complied |
| Alarm | Complied | Complied |

This report shall not be reproduced except in full, without the written approval of KES Co., Ltd.
 The results shown in this test report refer only to the sample(s) tested unless otherwise stated.

- PoE Mode

Input a.c. power ports – Coupling/Decoupling Network used

| Mode of Application | Observations | |
|---------------------|----------------|----------------|
| | (+) Burst (kV) | (-) Burst (kV) |
| - | - | - |

Input d.c. power ports – Coupling/Decoupling Network used

| Mode of Application | Observations | |
|---------------------|----------------|----------------|
| | (+) Burst (kV) | (-) Burst (kV) |
| - | - | - |

Signal ports and telecommunication ports – Coupling Clamp used

| Mode of Application | Observations | |
|---------------------|----------------|----------------|
| | (+) Burst (kV) | (-) Burst (kV) |
| RJ-45 | Complied | Complied |
| Alarm | Complied | Complied |

Note: “Blank” = Not performed

Observations:
 Complied – No degradation of function

Test Results

- PASS Required Performance Criteria
- NOT PASS Required Performance Criteria

Remarks

PASS Required Performance Criteria.

3.4 Surge Transients

Reference Standard

EN 61000-4-5: 2014

Test Date

Dec, 19, 2016

Test Location

EMS-Surge: Electro wave Shieldroom

Test Equipment

| Used | Description | Model Number | Manufacturer | Serial Number | Cal. Due |
|-------------------------------------|-------------------------|--------------|--------------|---------------|--------------|
| <input checked="" type="checkbox"/> | Ultra Compact Simulator | UCS 500 N5 | EM TEST | V0936105120 | 06, 27, 2017 |
| <input checked="" type="checkbox"/> | Motor Variac | MV2616 | EM TEST | V0936105123 | 06, 27, 2017 |
| <input type="checkbox"/> | CDN | CNV 504N | EM TEST | V0936105121 | 06, 27, 2017 |
| <input type="checkbox"/> | CDN | CNV 508T5 | EM TEST | P1549168422 | 04, 27, 2017 |
| <input checked="" type="checkbox"/> | CDN | CNV 508N1 | EM TEST | P1551168979 | 04, 27, 2017 |
| <input checked="" type="checkbox"/> | EMS Test S/W | iec.control | EM TEST AG | 5.0.9.0 | - |

Test Conditions

Temperature: 19,2 °C
Relative Humidity: 38,5 %
Atmospheric Pressure: 101,0 kPa



Test Specifications

AC Power Lines

Source Impedance: 12 ohm for common mode and 2 ohm for differential mode

Surge Amplitude : Common Mode
 (0,5 / 1,0 / 2,0) kV
Differential Mode
 (0,5 / 1,0) kV

Number of Surges: 5 surges per angle

Angle: 0°, 90°, 180°, 270° (input a.c. power port)

Polarity: Positive & Negative

Repetition Rate: 1 surge per min 1 surge per 30 sec.

Required Performance Criteria: Complied

Other supply / Signal Lines

Source Impedance: 42 ohm for common mode

Surge Amplitude: Common Mode
 (0,5 / 1,0) kV

Number of Surges: 5 Surges

Polarity: Positive & Negative

Repetition Rate: 1 surge per min 1 surge per 30 sec.

Required Performance Criteria: Complied

Test Data

- AC 24 V Mode

Line to Line – Differential Mode

| Mode of Application | Observations | |
|---------------------|----------------|----------------|
| | (+) Surge (kV) | (-) Surge (kV) |
| L – N | Complied | Complied |
| L – PE | - | - |
| N – PE | - | - |

Line to Earth – Common Mode

| Mode of Application | Observations | |
|---------------------|----------------|----------------|
| | (+) Surge (kV) | (-) Surge (kV) |
| - | - | - |

Signal Lines

Line to Earth – Common Mode

| Mode of Application | Observations | |
|---------------------|----------------|----------------|
| | (+) Surge (kV) | (-) Surge (kV) |
| RJ-45 | Complied | Complied |
| Alarm | Complied | Complied |

- DC 12 V Mode

Line to Line – Differential Mode

| Mode of Application | Observations | |
|---------------------|----------------|----------------|
| | (+) Surge (kV) | (-) Surge (kV) |
| L – N | - | - |
| L – PE | - | - |
| N – PE | - | - |

Line to Earth – Common Mode

| Mode of Application | Observations | |
|---------------------|----------------|----------------|
| | (+) Surge (kV) | (-) Surge (kV) |
| L1-PE | Complied | Complied |
| L2-PE | Complied | Complied |

Signal Lines

Line to Earth – Common Mode

| Mode of Application | Observations | |
|---------------------|----------------|----------------|
| | (+) Surge (kV) | (-) Surge (kV) |
| RJ-45 | Complied | Complied |
| Alarm | Complied | Complied |

This report shall not be reproduced except in full, without the written approval of KES Co., Ltd.
The results shown in this test report refer only to the sample(s) tested unless otherwise stated.

- POE Mode

Line to Line – Differential Mode

| Mode of Application | Observations | |
|---------------------|----------------|----------------|
| | (+) Surge (kV) | (-) Surge (kV) |
| L – N | - | - |
| L – PE | - | - |
| N – PE | - | - |

Line to Earth – Common Mode

| Mode of Application | Observations | |
|---------------------|----------------|----------------|
| | (+) Surge (kV) | (-) Surge (kV) |
| L1-PE | - | - |
| L2-PE | - | - |

Signal Lines

Line to Earth – Common Mode

| Mode of Application | Observations | |
|---------------------|----------------|----------------|
| | (+) Surge (kV) | (-) Surge (kV) |
| RJ-45 (PoE) | Complied | Complied |
| Alarm | Complied | Complied |

Note: "Blank" = Not performed

Observations:
 Complied – No degradation of function

Test Results

- PASS Required Performance Criteria
- NOT PASS Required Performance Criteria

Remarks

PASS Required Performance Criteria.

3.5 Conducted Disturbance

Reference Standard

EN 61000-4-6:2014

Test Date

Dec, 19, 2016

Test Location

EMS-CS: Electro wave Shieldroom

Test Equipment

| Used | Description | Model Number | Manufacturer | Serial Number | Cal. Due |
|-------------------------------------|---------------------------|--------------|--------------|---------------|--------------|
| <input checked="" type="checkbox"/> | Continuous Wave Generator | CWS 500N1 | EM TEST | V0936105119 | 08, 08, 2017 |
| <input checked="" type="checkbox"/> | 6 dB Attenuator | ATT6 | EM TEST | 1208-34 | 08, 08, 2017 |
| <input checked="" type="checkbox"/> | CDN | CDN-M2/M3N | EM TEST | 0909-06 | 08, 08, 2017 |
| <input type="checkbox"/> | CDN | CDN-T2-RJ11 | EM TEST | 0909-07 | 08, 08, 2017 |
| <input type="checkbox"/> | CDN | CDN-T4 | EM TEST | 0909-08 | 08, 08, 2017 |
| <input type="checkbox"/> | CDN | CDN-T8RJ45 | EM TEST | 0909-09 | 08, 08, 2017 |
| <input type="checkbox"/> | CDN | CDN-AF2 | EM TEST | 0909-10 | 08, 08, 2017 |
| <input type="checkbox"/> | CDN | CDN-AF4 | EM TEST | 0909-11 | 08, 08, 2017 |
| <input checked="" type="checkbox"/> | EM Injection Clamp | EM 101 | Liithi | 35943 | 02, 04, 2017 |
| <input checked="" type="checkbox"/> | EMS Test S/W | icd.control | EM TEST AG | 5.3.7 | - |

Test Conditions

Temperature: 19,2 °C
Relative Humidity: 38,5 %
Atmospheric Pressure: 101,0 kPa



KES Co., Ltd.

C-3701, Simin-daero 365-40,
Dongan-gu, Anyang-si, Gyeonggi-do, 14057, Korea
Tel: +82-31-425-6200 / Fax: +82-31-424-0450
www.kes.co.kr

Test report No.:
KES-E1-16T0673
Page (38) of (98)

Test Specifications

- Frequency range: 150 kHz to 100 MHz 150 kHz to 80 MHz
- Voltage Level: 1 Vrms 3 Vrms
 10 Vrms
- Modulation: AM, 80 %, 1 kHz sine wave
 PM, 1 Hz (0,5 s ON : 0,5 s OFF)
- Frequency step: 1 % step
- Dwell Time: 1 s 3 s
- Required Performance Criteria: Complied

This report shall not be reproduced except in full, without the written approval of KES Co., Ltd.
The results shown in this test report refer only to the sample(s) tested unless otherwise stated.

Test Data

- AC 24 V Mode

Input a.c. power ports

| Coupling Location (Line Stressed) | Coupling Method | Observations |
|--------------------------------------|--|--------------|
| L - N | CDN (<input checked="" type="checkbox"/> M2, <input type="checkbox"/> M3) | Complied |

Input d.c. power ports

| Coupling Location (Line Stressed) | Coupling Method | Observations |
|--------------------------------------|---|--------------|
| - | CDN (<input type="checkbox"/> M2, <input type="checkbox"/> M3) | - |

Signal ports and telecommunication ports

| Coupling Location (Line Stressed) | Coupling Method | Observations |
|--------------------------------------|-----------------|--------------|
| RJ-45 | Complied | Complied |
| Alarm | Complied | Complied |

- DC 12 V Mode

Input a.c. power ports

| Coupling Location (Line Stressed) | Coupling Method | Observations |
|--------------------------------------|---|--------------|
| - | CDN (<input type="checkbox"/> M2, <input type="checkbox"/> M3) | - |

Input d.c. power ports

| Coupling Location (Line Stressed) | Coupling Method | Observations |
|--------------------------------------|--|--------------|
| L1 - L2 | CDN (<input checked="" type="checkbox"/> M2, <input type="checkbox"/> M3) | Complied |

Signal ports and telecommunication ports

| Coupling Location (Line Stressed) | Coupling Method | Observations |
|--------------------------------------|-----------------|--------------|
| RJ-45 | Complied | Complied |
| Alarm | Complied | Complied |

This report shall not be reproduced except in full, without the written approval of KES Co., Ltd.
The results shown in this test report refer only to the sample(s) tested unless otherwise stated.



- PoE Mode

Input a.c. power ports

| Coupling Location (Line Stressed) | Coupling Method | Observations |
|--------------------------------------|---|--------------|
| - | CDN (<input type="checkbox"/> M2, <input type="checkbox"/> M3) | - |

Input d.c. power ports

| Coupling Location (Line Stressed) | Coupling Method | Observations |
|--------------------------------------|---|--------------|
| - | CDN (<input type="checkbox"/> M2, <input type="checkbox"/> M3) | - |

Signal ports and telecommunication ports

| Coupling Location (Line Stressed) | Coupling Method | Observations |
|--------------------------------------|-----------------|--------------|
| RJ-45 (PoE) | Complied | Complied |
| Alarm | Complied | Complied |

Notes: CDN = Coupling Decoupling Network
"blank" = Not performed

Observations:

Complied – No degradation of function

Test Results

- PASS Required Performance Criteria
- NOT PASS Required Performance Criteria

Remarks

PASS Required Performance Criteria.

3.6 Voltage Dips and Short Interruptions

Reference Standard

EN 61000-4-11:2004

Test Date

Dec, 19, 2016

Test Location

EMS-Voltage dip: Electro wave Shieldroom

Test Equipment

| Used | Description | Model Number | Manufacturer | Serial Number | Cal. Due |
|-------------------------------------|-------------------------|--------------|--------------|---------------|--------------|
| <input checked="" type="checkbox"/> | Ultra Compact Simulator | UCS 500 N5 | EM TEST | V0936105120 | 06, 27, 2017 |
| <input checked="" type="checkbox"/> | Motor Variac | MV2616 | EM TEST | V0936105123 | 06, 27, 2017 |
| <input checked="" type="checkbox"/> | EMS Test S/W | iec.control | EM TEST AG | 5.0.9.0 | - |

Test ConditionsTemperature: 19,2 °C
Relative Humidity: 38,5 %
Atmospheric Pressure: 101,0 kPa



Test Specifications & Observations/Remarks

- AC 24 V Mode

(Test Voltage : 50 Hz)

| <u>Test Level</u> | <u>Duration [in period/ms (50 Hz)]</u> | <u>Results</u> |
|---|---|-----------------|
| <input checked="" type="checkbox"/> 20 % dip | <input checked="" type="checkbox"/> 250 /5000 | <u>Complied</u> |
| <input checked="" type="checkbox"/> 30 % dip | <input checked="" type="checkbox"/> 25 /500 | <u>Complied</u> |
| <input checked="" type="checkbox"/> 60 % dip | <input checked="" type="checkbox"/> 10 /200 | <u>Complied</u> |
| <input checked="" type="checkbox"/> 100 % dip | <input checked="" type="checkbox"/> 250 /5000 | <u>Complied</u> |

- Voltage variations

| | | |
|---|--|-----------------|
| <input checked="" type="checkbox"/> Unom + 10 % | <input checked="" type="checkbox"/> 243 V (ac) | <u>Complied</u> |
| <input checked="" type="checkbox"/> Unom - 15 % | <input checked="" type="checkbox"/> 195.5 V (ac) | <u>Complied</u> |

Observations:

Complied – No degradation of function

Test Results

- PASS Required Performance Criteria
- NOT PASS Required Performance Criteria
- NOT APPLICABLE

Remarks

The test has been tested using the AC/AC Adapter

APPENDIX A – TEST DATA

Conducted Emissions at Mains Power Ports

- AC 24 V Mode

[HOT]

Common Information

| | |
|-------------------|--------------------|
| Test Description: | Conducted Emission |
| Model No.: | XNV-6080RP |
| Mode | AC 24 V _ H |
| Operator Name: | KES |

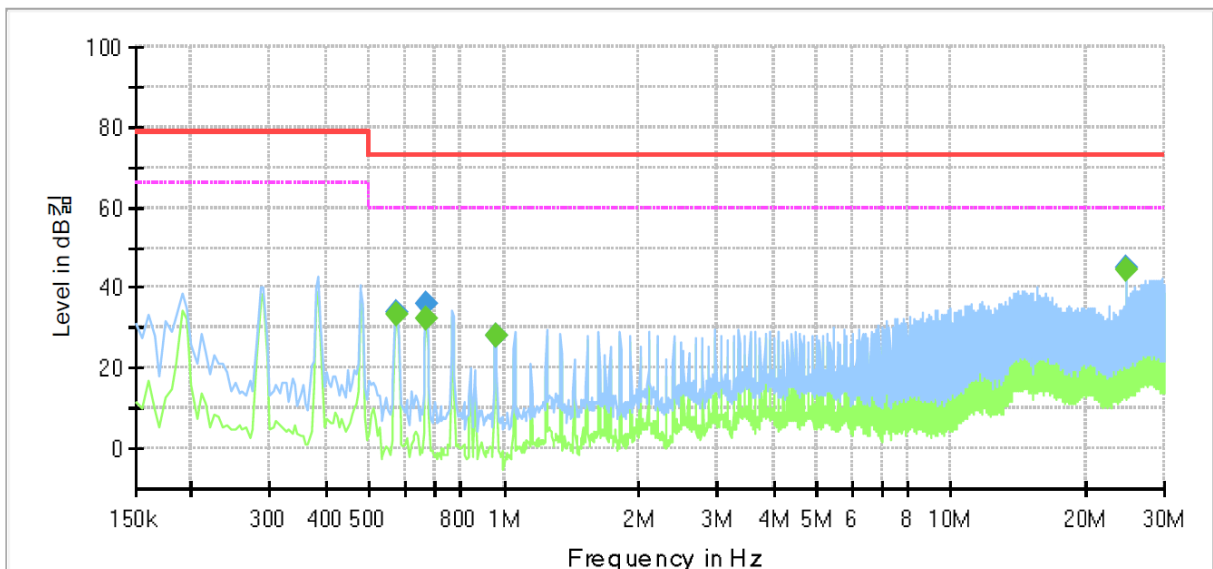

Final Result

| Frequency (MHz) | QuasiPeak (dBμV) | CAverage (dBμV) | Limit (dBμV) | Margin (dB) | Meas. Time (ms) | Bandwidth (kHz) | Line | Corr. (dB) |
|-----------------|------------------|-----------------|--------------|-------------|-----------------|-----------------|------|------------|
| 0.575000 | --- | 33.51 | 60.00 | 26.49 | 1000.0 | 9.000 | L1 | 9.9 |
| 0.575000 | 34.13 | --- | 73.00 | 38.87 | 1000.0 | 9.000 | L1 | 9.9 |
| 0.670000 | --- | 32.34 | 60.00 | 27.66 | 1000.0 | 9.000 | L1 | 9.9 |
| 0.670000 | 35.90 | --- | 73.00 | 37.10 | 1000.0 | 9.000 | L1 | 9.9 |
| 0.960000 | --- | 27.85 | 60.00 | 32.15 | 1000.0 | 9.000 | L1 | 10.0 |
| 0.960000 | 28.34 | --- | 73.00 | 44.66 | 1000.0 | 9.000 | L1 | 10.0 |
| 24.575000 | --- | 44.45 | 60.00 | 15.55 | 1000.0 | 9.000 | L1 | 10.3 |
| 24.575000 | 44.82 | --- | 73.00 | 28.18 | 1000.0 | 9.000 | L1 | 10.3 |

◆ Calculation

QuasiPeak [dBuV] / CAverage [dBuV] = Reading Value [dBuV] + Corr. [dB]

QuasiPeak / CAverage : The Final Value

Reading Value : Not shown in the table.

Corr. : Correction values (LISN FACTOR+ Cable Loss)

This report shall not be reproduced except in full, without the written approval of KES Co., Ltd.
The results shown in this test report refer only to the sample(s) tested unless otherwise stated.

[NEUTRAL]

Common Information

| | |
|-------------------|--------------------|
| Test Description: | Conducted Emission |
| Model No.: | XNV-6080RP |
| Mode | AC 24 V _ N |
| Operator Name: | KES |

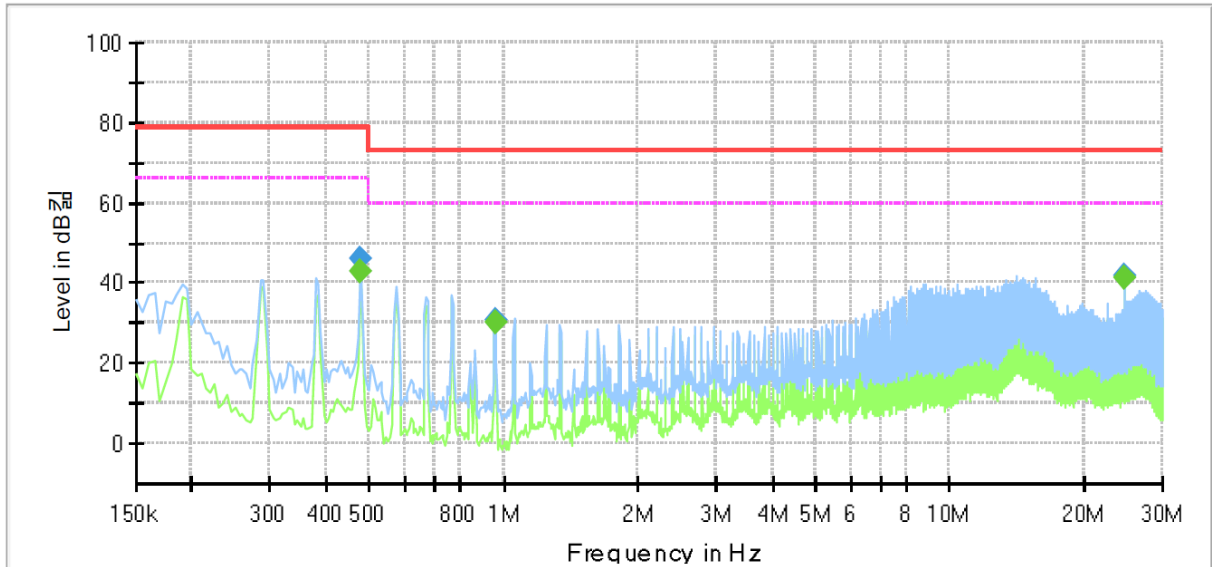

Final Result

| Frequency (MHz) | QuasiPeak (dBμV) | CAverage (dBμV) | Limit (dBμV) | Margin (dB) | Meas. Time (ms) | Bandwidth (kHz) | Line | Corr. (dB) |
|-----------------|------------------|-----------------|--------------|-------------|-----------------|-----------------|------|------------|
| 0.480000 | --- | 43.01 | 66.00 | 22.99 | 1000.0 | 9.000 | N | 9.8 |
| 0.480000 | 46.23 | --- | 79.00 | 32.77 | 1000.0 | 9.000 | N | 9.8 |
| 0.960000 | --- | 30.34 | 60.00 | 29.66 | 1000.0 | 9.000 | N | 10.0 |
| 0.960000 | 30.79 | --- | 73.00 | 42.21 | 1000.0 | 9.000 | N | 10.0 |
| 24.575000 | --- | 41.53 | 60.00 | 18.47 | 1000.0 | 9.000 | N | 10.3 |
| 24.575000 | 41.89 | --- | 73.00 | 31.11 | 1000.0 | 9.000 | N | 10.3 |

◆ Calculation

QuasiPeak [dBμV] / CAverage [dBμV] = Reading Value [dBμV] + Corr. [dB]

QuasiPeak / CAverage : The Final Value

Reading Value : Not shown in the table.

Corr. : Correction values (LISN FACTOR+ Cable Loss)

Conducted Emissions at Telecommunication Ports

- AC 24 V Mode

[10 Mbps]

Common Information

| | |
|-------------------|----------------------------|
| Test Description: | Telecommunication Emission |
| Model No.: | XNV-6080RP |
| Mode | AC 24 V 10 Mbps |
| Operator Name: | KES |

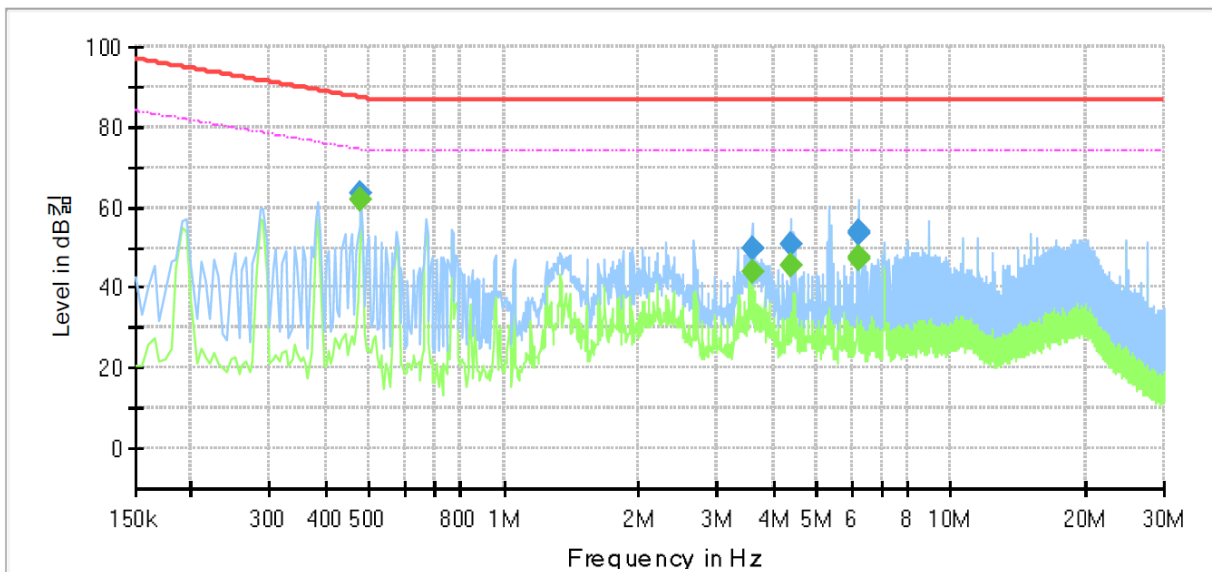

Final Result

| Frequency (MHz) | QuasiPeak (dBμV) | CAverage (dBμV) | Limit (dBμV) | Margin (dB) | Meas. Time (ms) | Bandwidth (kHz) | Line | Corr. (dB) |
|-----------------|------------------|-----------------|--------------|-------------|-----------------|-----------------|-------------|------------|
| 0.480000 | --- | 62.02 | 74.34 | 12.32 | 1000.0 | 9.000 | Single Line | 10.1 |
| 0.480000 | 63.65 | --- | 87.34 | 23.69 | 1000.0 | 9.000 | Single Line | 10.1 |
| 3.585000 | --- | 43.78 | 74.00 | 30.22 | 1000.0 | 9.000 | Single Line | 10.2 |
| 3.585000 | 49.88 | --- | 87.00 | 37.12 | 1000.0 | 9.000 | Single Line | 10.2 |
| 4.405000 | --- | 45.53 | 74.00 | 28.47 | 1000.0 | 9.000 | Single Line | 10.1 |
| 4.405000 | 50.61 | --- | 87.00 | 36.39 | 1000.0 | 9.000 | Single Line | 10.1 |
| 6.195000 | --- | 47.32 | 74.00 | 26.68 | 1000.0 | 9.000 | Single Line | 10.1 |
| 6.195000 | 53.29 | --- | 87.00 | 33.71 | 1000.0 | 9.000 | Single Line | 10.1 |
| 6.245000 | --- | 47.76 | 74.00 | 26.24 | 1000.0 | 9.000 | Single Line | 10.1 |
| 6.245000 | 53.78 | --- | 87.00 | 33.22 | 1000.0 | 9.000 | Single Line | 10.1 |

◆ Calculation

QuasiPeak [dBuV] / CAverage [dBuV] = Reading Value [dBuV] + Corr. [dB]

QuasiPeak / CAverage : The Final Value

Reading Value : Not shown in the table.

Corr. : Correction values (ISN FACTOR+ Cable Loss)

This report shall not be reproduced except in full, without the written approval of KES Co., Ltd.
The results shown in this test report refer only to the sample(s) tested unless otherwise stated.

[100 Mbps]

Common Information

| | |
|-------------------|----------------------------|
| Test Description: | Telecommunication Emission |
| Model No.: | XNV-6080RP |
| Mode | AC 24 V 100 Mbps |
| Operator Name: | KES |

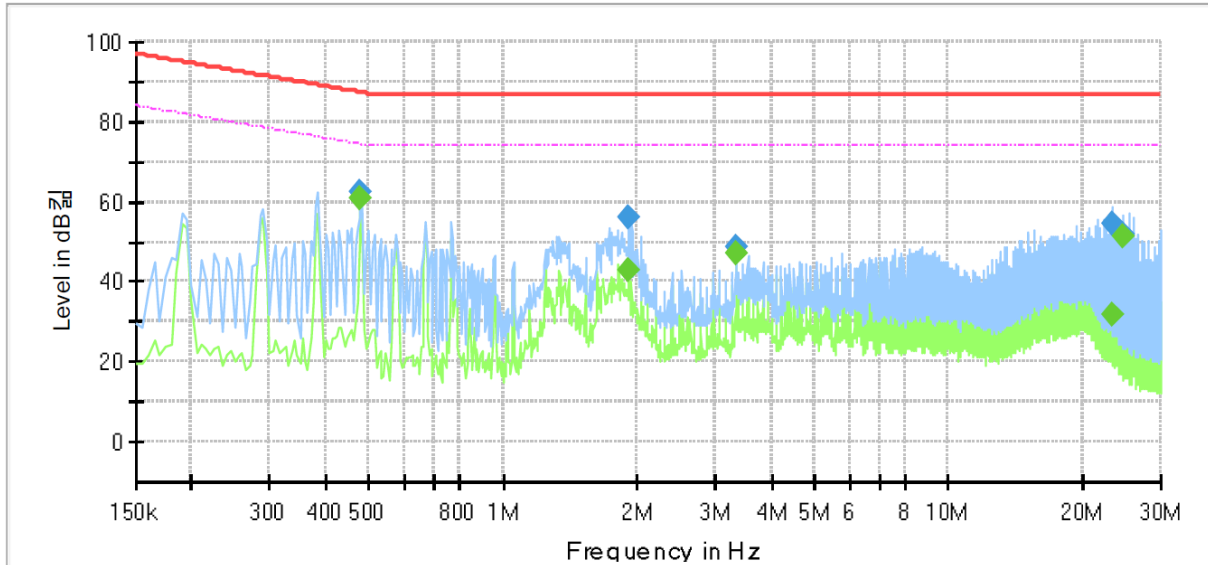

Final Result

| Frequency (MHz) | QuasiPeak (dBμV) | CAverage (dBμV) | Limit (dBμV) | Margin (dB) | Meas. Time (ms) | Bandwidth (kHz) | Line | Corr. (dB) |
|-----------------|------------------|-----------------|--------------|-------------|-----------------|-----------------|-------------|------------|
| 0.480000 | --- | 60.73 | 74.34 | 13.61 | 1000.0 | 9.000 | Single Line | 9.6 |
| 0.480000 | 62.52 | --- | 87.34 | 24.82 | 1000.0 | 9.000 | Single Line | 9.6 |
| 1.910000 | --- | 42.67 | 74.00 | 31.33 | 1000.0 | 9.000 | Single Line | 9.7 |
| 1.910000 | 55.97 | --- | 87.00 | 31.03 | 1000.0 | 9.000 | Single Line | 9.7 |
| 3.330000 | --- | 47.26 | 74.00 | 26.74 | 1000.0 | 9.000 | Single Line | 9.7 |
| 3.330000 | 48.77 | --- | 87.00 | 38.23 | 1000.0 | 9.000 | Single Line | 9.7 |
| 23.325000 | --- | 31.62 | 74.00 | 42.38 | 1000.0 | 9.000 | Single Line | 9.5 |
| 23.325000 | 54.61 | --- | 87.00 | 32.39 | 1000.0 | 9.000 | Single Line | 9.5 |
| 24.575000 | --- | 51.44 | 74.00 | 22.56 | 1000.0 | 9.000 | Single Line | 9.5 |
| 24.575000 | 51.76 | --- | 87.00 | 35.24 | 1000.0 | 9.000 | Single Line | 9.5 |

◆ Calculation

QuasiPeak [dBuV] / CAverage [dBuV] = Reading Value [dBuV] + Corr. [dB]

QuasiPeak / CAverage : The Final Value

Reading Value : Not shown in the table.

Corr. : Correction values (ISN FACTOR+ Cable Loss)

- DC 12 V Mode

[10 Mbps]

Common Information

| | |
|-------------------|----------------------------|
| Test Description: | Telecommunication Emission |
| Model No.: | XNV-6080RP |
| Mode | DC 12 V 10 Mbps |
| Operator Name: | KES |

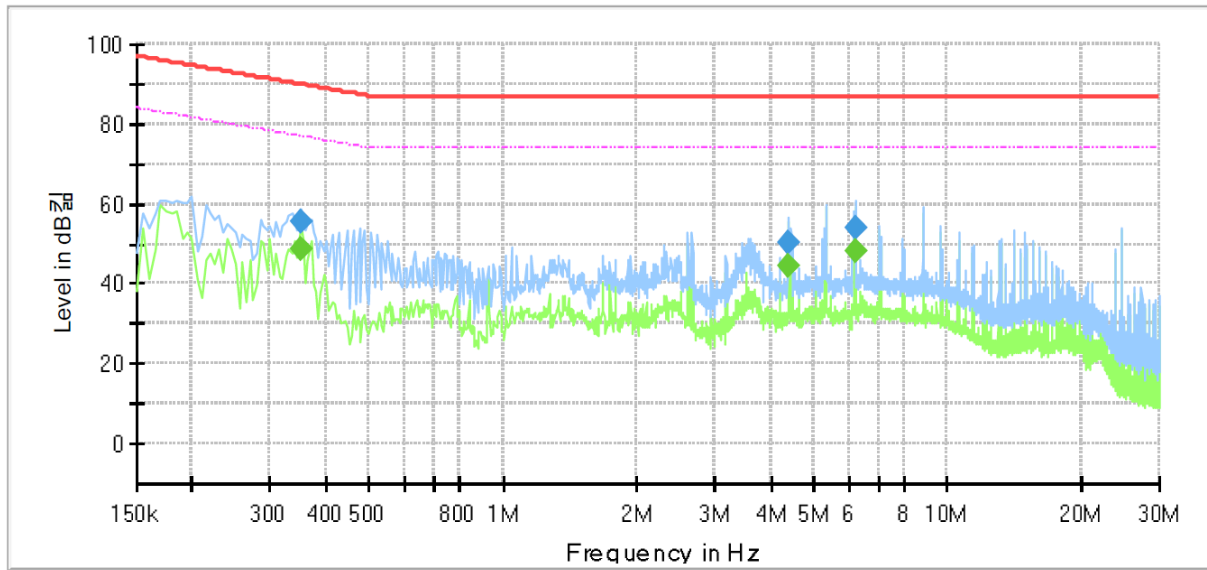

Final Result

| Frequency (MHz) | QuasiPeak (dBμV) | CAverage (dBμV) | Limit (dBμV) | Margin (dB) | Meas. Time (ms) | Bandwidth (kHz) | Line | Corr. (dB) |
|-----------------|------------------|-----------------|--------------|-------------|-----------------|-----------------|-------------|------------|
| 0.350000 | --- | 48.74 | 76.96 | 28.22 | 1000.0 | 9.000 | Single Line | 10.1 |
| 0.350000 | 55.58 | --- | 89.96 | 34.38 | 1000.0 | 9.000 | Single Line | 10.1 |
| 4.400000 | --- | 44.53 | 74.00 | 29.47 | 1000.0 | 9.000 | Single Line | 10.1 |
| 4.400000 | 50.47 | --- | 87.00 | 36.53 | 1000.0 | 9.000 | Single Line | 10.1 |
| 6.195000 | --- | 48.27 | 74.00 | 25.73 | 1000.0 | 9.000 | Single Line | 10.1 |
| 6.195000 | 54.01 | --- | 87.00 | 32.99 | 1000.0 | 9.000 | Single Line | 10.1 |

◆ Calculation

QuasiPeak [dBuV] / CAverage [dBuV] = Reading Value [dBuV] + Corr. [dB]

QuasiPeak / CAverage : The Final Value

Reading Value : Not shown in the table.

Corr. : Correction values (ISN FACTOR+ Cable Loss)

This report shall not be reproduced except in full, without the written approval of KES Co., Ltd.
The results shown in this test report refer only to the sample(s) tested unless otherwise stated.

[100 Mbps]

Common Information

| | |
|-------------------|----------------------------|
| Test Description: | Telecommunication Emission |
| Model No.: | XNV-6080RP |
| Mode | DC 12 V 100 Mbps |
| Operator Name: | KES |

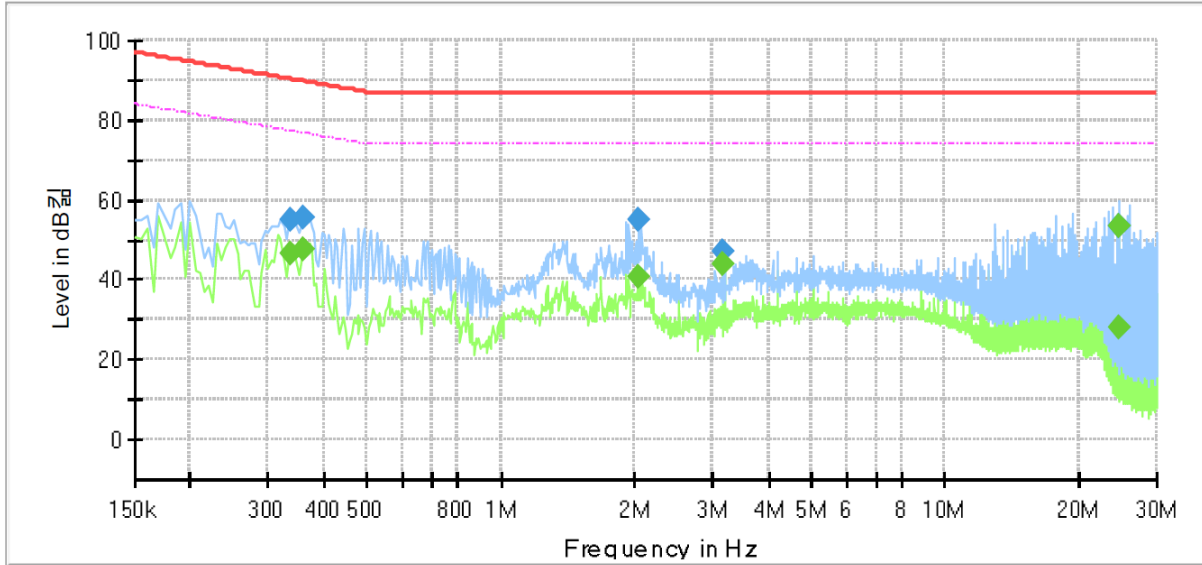

Final Result

| Frequency (MHz) | QuasiPeak (dBμV) | CAverage (dBμV) | Limit (dBμV) | Margin (dB) | Meas. Time (ms) | Bandwidth (kHz) | Line | Corr. (dB) |
|-----------------|------------------|-----------------|--------------|-------------|-----------------|-----------------|-------------|------------|
| 0.335000 | --- | 46.67 | 77.33 | 30.66 | 1000.0 | 9.000 | Single Line | 9.6 |
| 0.335000 | 54.97 | --- | 90.33 | 35.36 | 1000.0 | 9.000 | Single Line | 9.6 |
| 0.360000 | --- | 47.83 | 76.73 | 28.90 | 1000.0 | 9.000 | Single Line | 9.6 |
| 0.360000 | 55.74 | --- | 89.73 | 33.99 | 1000.0 | 9.000 | Single Line | 9.6 |
| 2.040000 | --- | 40.76 | 74.00 | 33.24 | 1000.0 | 9.000 | Single Line | 9.7 |
| 2.040000 | 54.90 | --- | 87.00 | 32.10 | 1000.0 | 9.000 | Single Line | 9.7 |
| 3.175000 | --- | 43.83 | 74.00 | 30.17 | 1000.0 | 9.000 | Single Line | 9.7 |
| 3.175000 | 47.35 | --- | 87.00 | 39.65 | 1000.0 | 9.000 | Single Line | 9.7 |
| 24.575000 | --- | 53.41 | 74.00 | 20.59 | 1000.0 | 9.000 | Single Line | 9.5 |
| 24.575000 | 53.62 | --- | 87.00 | 33.38 | 1000.0 | 9.000 | Single Line | 9.5 |
| 24.730000 | --- | 27.90 | 74.00 | 46.10 | 1000.0 | 9.000 | Single Line | 9.5 |
| 24.730000 | 53.67 | --- | 87.00 | 33.33 | 1000.0 | 9.000 | Single Line | 9.5 |

◆ Calculation

QuasiPeak [dBuV] / CAverage [dBuV] = Reading Value [dBuV] + Corr. [dB]

QuasiPeak / CAverage : The Final Value

Reading Value : Not shown in the table.

Corr. : Correction values (ISN FACTOR+ Cable Loss)

- PoE Mode

[10 Mbps]

Common Information

| | |
|-------------------|----------------------------|
| Test Description: | Telecommunication Emission |
| Model No.: | XNV-6080RP |
| Mode | POE_10M |
| Operator Name: | KES |

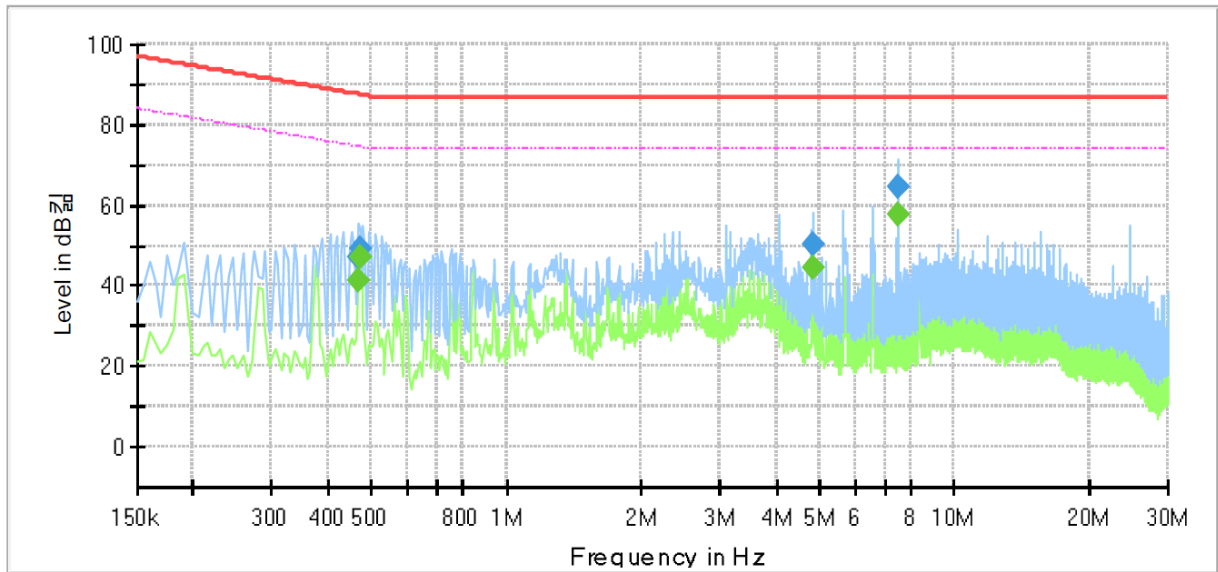

Final Result

| Frequency (MHz) | QuasiPeak (dBμV) | CAverage (dBμV) | Limit (dBμV) | Margin (dB) | Meas. Time (ms) | Bandwidth (kHz) | Line | Corr. (dB) |
|-----------------|------------------|-----------------|--------------|-------------|-----------------|-----------------|-------------|------------|
| 0.465000 | --- | 41.09 | 74.60 | 33.51 | 1000.0 | 9.000 | Single Line | 10.1 |
| 0.465000 | 47.16 | --- | 87.60 | 40.44 | 1000.0 | 9.000 | Single Line | 10.1 |
| 0.470000 | --- | 47.25 | 74.51 | 27.26 | 1000.0 | 9.000 | Single Line | 10.1 |
| 0.470000 | 49.36 | --- | 87.51 | 38.15 | 1000.0 | 9.000 | Single Line | 10.1 |
| 4.835000 | --- | 44.59 | 74.00 | 29.41 | 1000.0 | 9.000 | Single Line | 10.1 |
| 4.835000 | 50.49 | --- | 87.00 | 36.51 | 1000.0 | 9.000 | Single Line | 10.1 |
| 7.500000 | --- | 57.62 | 74.00 | 16.38 | 1000.0 | 9.000 | Single Line | 10.0 |
| 7.500000 | 64.39 | --- | 87.00 | 22.61 | 1000.0 | 9.000 | Single Line | 10.0 |

◆ Calculation

QuasiPeak [dBuV] / CAverage [dBuV] = Reading Value [dBuV] + Corr. [dB]

QuasiPeak / CAverage : The Final Value

Reading Value : Not shown in the table.

Corr. : Correction values (ISN FACTOR+ Cable Loss)

[100 Mbps]

Common Information

| | |
|-------------------|----------------------------|
| Test Description: | Telecommunication Emission |
| Model No.: | XNV-6080RP |
| Mode | POE_100M |
| Operator Name: | KES |

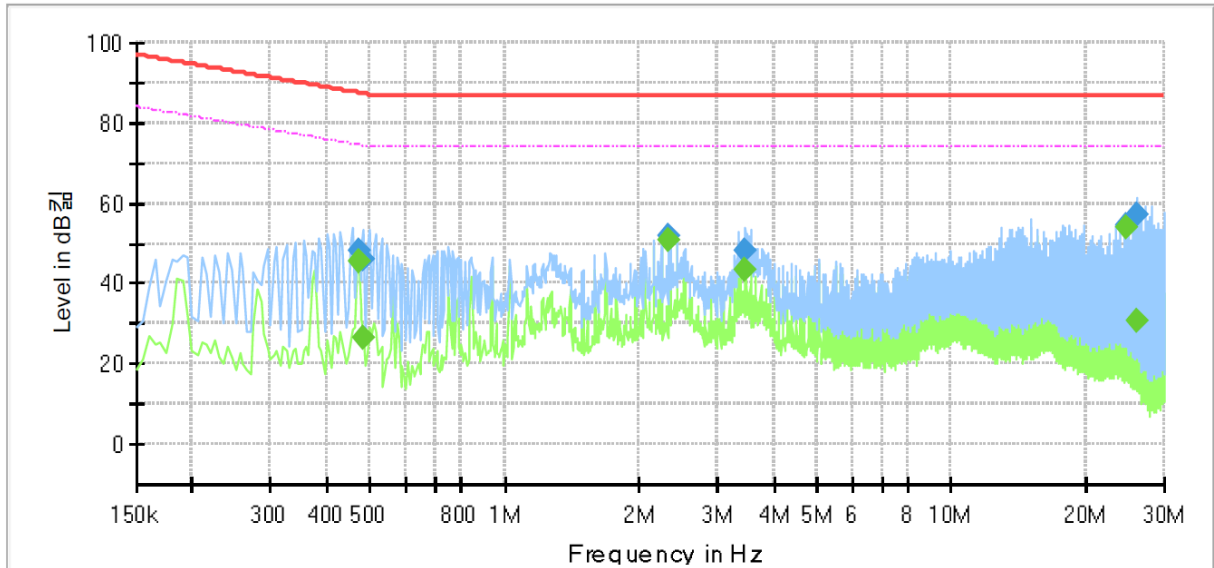

Final Result

| Frequency (MHz) | QuasiPeak (dBμV) | CAverage (dBμV) | Limit (dBμV) | Margin (dB) | Meas. Time (ms) | Bandwidth (kHz) | Line | Corr. (dB) |
|-----------------|------------------|-----------------|--------------|-------------|-----------------|-----------------|-------------|------------|
| 0.470000 | --- | 45.60 | 74.51 | 28.91 | 1000.0 | 9.000 | Single Line | 9.6 |
| 0.470000 | 48.27 | --- | 87.51 | 39.24 | 1000.0 | 9.000 | Single Line | 9.6 |
| 0.485000 | --- | 26.59 | 74.25 | 47.66 | 1000.0 | 9.000 | Single Line | 9.6 |
| 0.485000 | 46.13 | --- | 87.25 | 41.12 | 1000.0 | 9.000 | Single Line | 9.6 |
| 2.340000 | --- | 50.90 | 74.00 | 23.10 | 1000.0 | 9.000 | Single Line | 9.7 |
| 2.340000 | 51.87 | --- | 87.00 | 35.13 | 1000.0 | 9.000 | Single Line | 9.7 |
| 3.465000 | --- | 43.39 | 74.00 | 30.61 | 1000.0 | 9.000 | Single Line | 9.7 |
| 3.465000 | 48.03 | --- | 87.00 | 38.97 | 1000.0 | 9.000 | Single Line | 9.7 |
| 24.575000 | --- | 54.03 | 74.00 | 19.97 | 1000.0 | 9.000 | Single Line | 9.5 |
| 24.575000 | 54.29 | --- | 87.00 | 32.71 | 1000.0 | 9.000 | Single Line | 9.5 |
| 26.015000 | --- | 30.66 | 74.00 | 43.34 | 1000.0 | 9.000 | Single Line | 9.5 |
| 26.015000 | 57.13 | --- | 87.00 | 29.87 | 1000.0 | 9.000 | Single Line | 9.5 |

◆ Calculation

QuasiPeak [dBuV] / CAverage [dBuV] = Reading Value [dBuV] + Corr. [dB]

QuasiPeak / CAverage : The Final Value

Reading Value : Not shown in the table.

Corr. : Correction values (ISN FACTOR+ Cable Loss)

This report shall not be reproduced except in full, without the written approval of KES Co., Ltd.
The results shown in this test report refer only to the sample(s) tested unless otherwise stated.



Radiated Electric Field Emissions(Below 1 GHz)

- AC 24 V Mode

| Frequency [MHz] | Amplitude [dB μ V] | ANT Polar. (H/V) | ANT. Height [m] | Correction Factor | | Corrected Amplitude [dB μ V/m] | Applicable Limit [dB μ V/m] | Margin [dB] |
|--------------------|---------------------------|------------------------|--------------------|-------------------|---------------|--|---------------------------------------|----------------|
| | | | | ANT. [dB/m] | Cable [dB] | | | |
| 147.37 | 8.29 | H | 3.74 | 8.11 | 3.54 | 19.94 | 40.00 | 20.06 |
| 227.69 | 9.29 | H | 4.00 | 11.91 | 4.45 | 25.65 | 40.00 | 14.35 |
| 325.68 | 13.31 | V | 1.29 | 13.98 | 5.40 | 32.69 | 47.00 | 14.31 |
| 400.05 | 8.14 | H | 4.00 | 15.70 | 6.17 | 30.01 | 47.00 | 16.99 |
| 530.34 | 17.23 | V | 1.15 | 17.77 | 7.25 | 42.25 | 47.00 | 4.75 |
| 624.33 | 8.71 | V | 1.28 | 19.40 | 7.99 | 36.10 | 47.00 | 10.90 |

* H : Horizontal, V : Vertical

◆ Calculation

Corrected Amplitude [dB μ V] = Amplitude[dBuV] + Correction Factor [dB]

Corrected Amplitude : The Final Value, Amplitude : Reading Value,

Correction Factor : ANT FACTOR + Cable loss



- DC 12 V Mode

| Frequency [MHz] | Amplitude [dBμV] | ANT Polar. (H/V) | ANT. Height [m] | Correction Factor | | Corrected Amplitude [dBμV/m] | Applicable Limit [dBμV/m] | Margin [dB] |
|--------------------|---------------------|------------------------|--------------------|-------------------|---------------|------------------------------------|---------------------------------|----------------|
| | | | | ANT. [dB/m] | Cable [dB] | | | |
| 152.62 | 8.38 | H | 3.90 | 8.29 | 3.60 | 20.27 | 40.00 | 19.73 |
| 221.26 | 9.27 | H | 3.94 | 11.77 | 4.37 | 25.41 | 40.00 | 14.59 |
| 336.98 | 12.61 | V | 1.36 | 14.24 | 5.51 | 32.36 | 47.00 | 14.64 |
| 475.81 | 8.69 | H | 3.61 | 16.76 | 6.90 | 32.35 | 47.00 | 14.65 |
| 530.33 | 14.26 | V | 1.00 | 17.77 | 7.25 | 39.28 | 47.00 | 7.72 |
| 624.33 | 8.67 | V | 1.28 | 19.40 | 7.99 | 36.06 | 47.00 | 10.94 |

* H : Horizontal, V : Vertical

◆ Calculation

Corrected Amplitude [dBuV] = Amplitude[dBuV] + Correction Factor [dB]
 Corrected Amplitude : The Final Value, Amplitude : Reading Value,
 Correction Factor : ANT FACTOR + Cable loss

- PoE Mode

| Frequency [MHz] | Amplitude [dBμV] | ANT Polar. (H/V) | ANT. Height [m] | Correction Factor | | Corrected Amplitude [dBμV/m] | Applicable Limit [dBμV/m] | Margin [dB] |
|--------------------|---------------------|------------------------|--------------------|-------------------|---------------|------------------------------------|---------------------------------|----------------|
| | | | | ANT. [dB/m] | Cable [dB] | | | |
| 147.62 | 8.15 | V | 1.57 | 8.11 | 3.54 | 19.80 | 40.00 | 20.20 |
| 224.36 | 9.14 | H | 3.88 | 11.84 | 4.41 | 25.39 | 40.00 | 14.61 |
| 325.87 | 11.15 | H | 3.79 | 13.98 | 5.40 | 30.53 | 47.00 | 16.47 |
| 400.03 | 7.92 | V | 1.21 | 15.70 | 6.17 | 29.79 | 47.00 | 17.21 |
| 538.28 | 9.12 | H | 3.76 | 17.94 | 7.31 | 34.37 | 47.00 | 12.63 |
| 624.60 | 9.31 | V | 1.00 | 19.40 | 7.99 | 36.70 | 47.00 | 10.30 |

* H : Horizontal, V : Vertical

◆ Calculation

Corrected Amplitude [dBuV] = Amplitude[dBuV] + Correction Factor [dB]
 Corrected Amplitude : The Final Value, Amplitude : Reading Value,
 Correction Factor : ANT FACTOR + Cable loss

Radiated Electric Field Emissions(Above 1 GHz)

- AC 24 V Mode

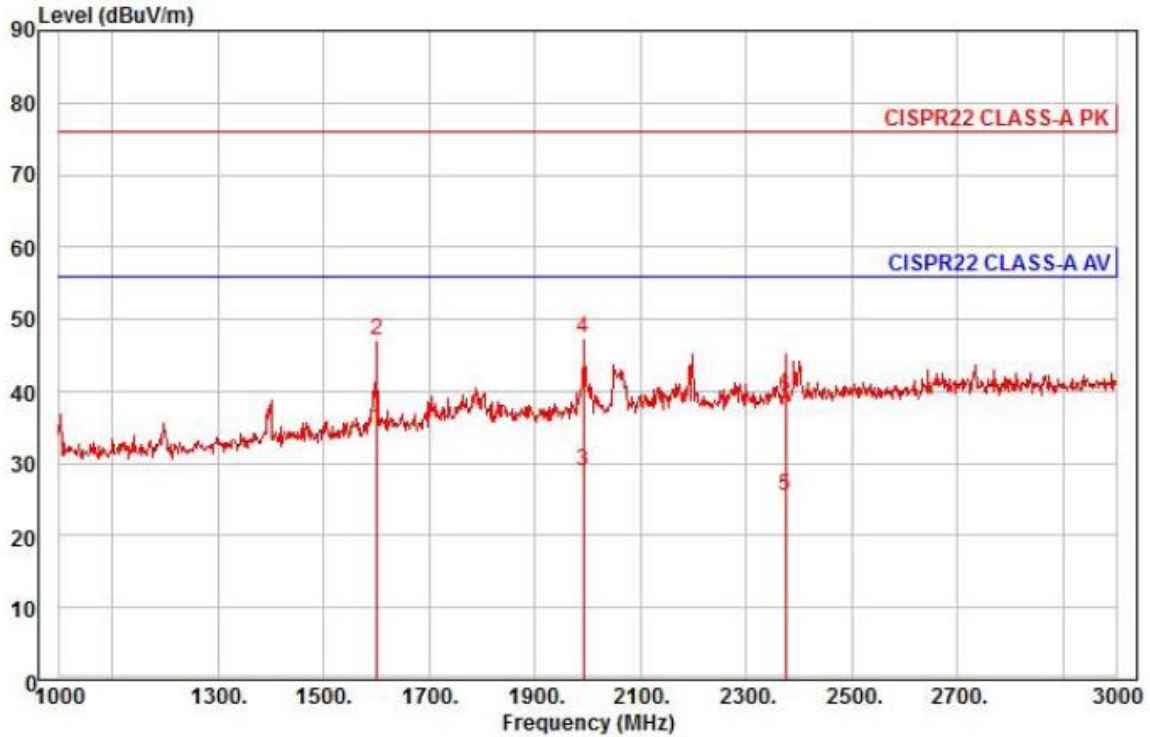

Site : chamber
Condition: CISPR22 CLASS-A PK 3m HORN781(2015.05.07) horizontal
: RBW:1000.000kHz VBW:1000.000kHz SWT:Auto
Project :
Model : XNV-6080RP
Mode : AC 24 V
Memo :

| | Freq | Read Level | Ant Factor | Cable Loss | Preamp Factor | TPos | Limit Line | Over Limit | Pol/Phase | Remark |
|------|---------|------------|------------|------------|---------------|------|------------|------------|------------|---------|
| | MHz | dBuV | dB/m | dB | dB | deg | dBuV/m | dB | | |
| 1 pp | 1600.00 | 39.54 | 26.29 | 8.31 | 39.22 | 24 | 56.00 | -21.08 | horizontal | Average |
| 2 | 1600.00 | 51.78 | 26.29 | 8.31 | 39.22 | 24 | 76.00 | -28.84 | horizontal | Peak |
| 3 | 1992.00 | 31.07 | 27.85 | 9.32 | 39.41 | 79 | 56.00 | -27.17 | horizontal | Average |
| 4 pk | 1992.00 | 49.58 | 27.85 | 9.32 | 39.41 | 79 | 76.00 | -28.66 | horizontal | Peak |
| 5 | 2374.00 | 25.92 | 28.80 | 10.26 | 39.42 | 146 | 56.00 | -30.44 | horizontal | Average |
| 6 | 2374.00 | 39.48 | 28.80 | 10.26 | 39.42 | 146 | 76.00 | -36.88 | horizontal | Peak |

◆ Calculation

Over Limit [dB] = (Read Level[dBuV] + Ant Factor[dB/m] + Cable Loss [dB] - Preamp Factor [dB]) - Limit Line[dBuV]

Over Limit : Margin Value, Read Level : Reading Value, Ant Factor : Ant Factor,
Cable Loss : Cable loss, Preamp Factor : Preamp Factor

This report shall not be reproduced except in full, without the written approval of KES Co., Ltd.
The results shown in this test report refer only to the sample(s) tested unless otherwise stated.

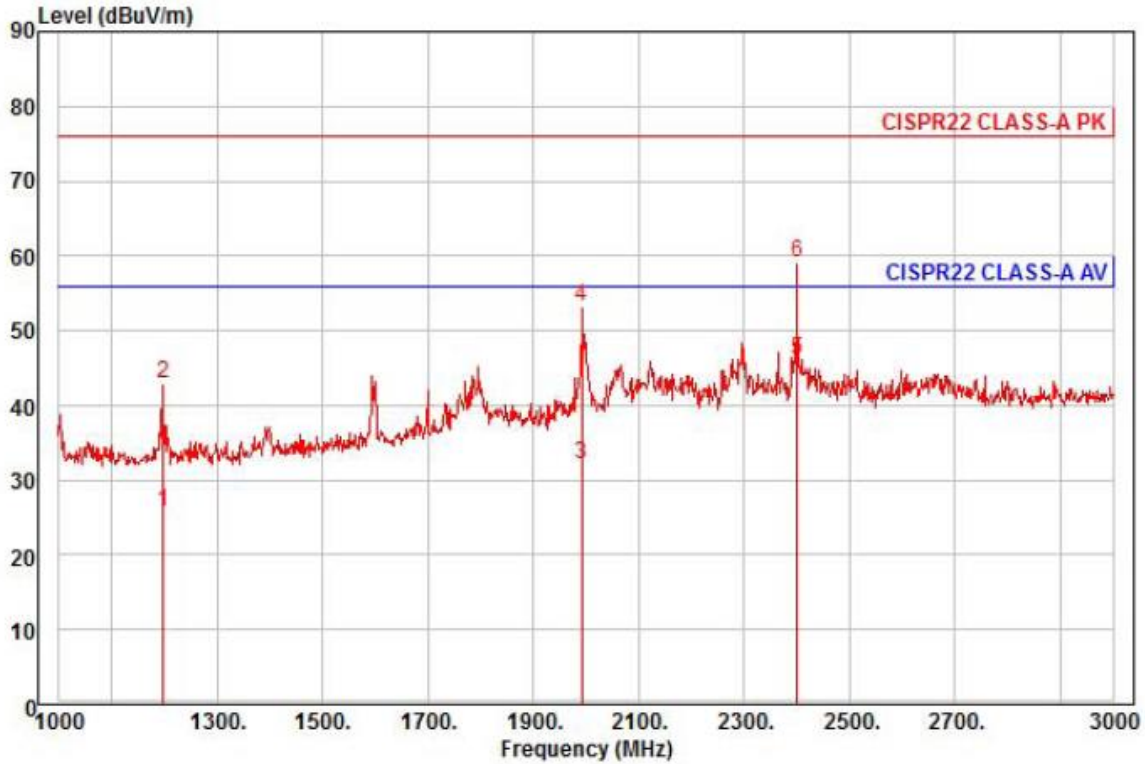

Site : chamber
 Condition: CISPR22 CLASS-A PK 3m HORN781(2015.05.07) vertical
 : RBW:1000.000kHz VBW:1000.000kHz SWT:Auto
 Project :
 Model : XNV-6080RP
 Mode : AC 24 V
 Memo :

| | Read Freq | Read Level | Ant Factor | Cable Loss | Preamp Factor | TPos | Limit Line | Over Limit | Pol/Phase | Remark |
|------|-----------|------------|------------|------------|---------------|------|------------|------------|-----------|---------|
| | MHz | dBuV | dB/m | dB | dB | deg | dBuV/m | dB | | |
| 1 | 1198.00 | 33.63 | 24.70 | 7.13 | 39.61 | 80 | 56.00 | -30.15 | vertical | Average |
| 2 | 1198.00 | 50.62 | 24.70 | 7.13 | 39.61 | 80 | 76.00 | -33.16 | vertical | Peak |
| 3 | 1992.00 | 34.34 | 27.85 | 9.32 | 39.41 | 10 | 56.00 | -23.90 | vertical | Average |
| 4 | 1992.00 | 55.57 | 27.85 | 9.32 | 39.41 | 10 | 76.00 | -22.67 | vertical | Peak |
| 5 pp | 2400.00 | 46.23 | 28.86 | 10.32 | 39.42 | 13 | 56.00 | -10.01 | vertical | Average |
| 6 pk | 2400.00 | 59.45 | 28.86 | 10.32 | 39.42 | 13 | 76.00 | -16.79 | vertical | Peak |

◆ Calculation

$$\text{Over Limit [dB]} = (\text{Read Level [dBuV]} + \text{Ant Factor [dB/m]} + \text{Cable Loss [dB]} - \text{Preamp Factor [dB]}) - \text{Limit Line [dBuV]}$$

Over Limit : Margin Value, Read Level : Reading Value, Ant Factor : Ant Factor,
 Cable Loss : Cable loss, Preamp Factor : Preamp Factor

This report shall not be reproduced except in full, without the written approval of KES Co., Ltd.
 The results shown in this test report refer only to the sample(s) tested unless otherwise stated.

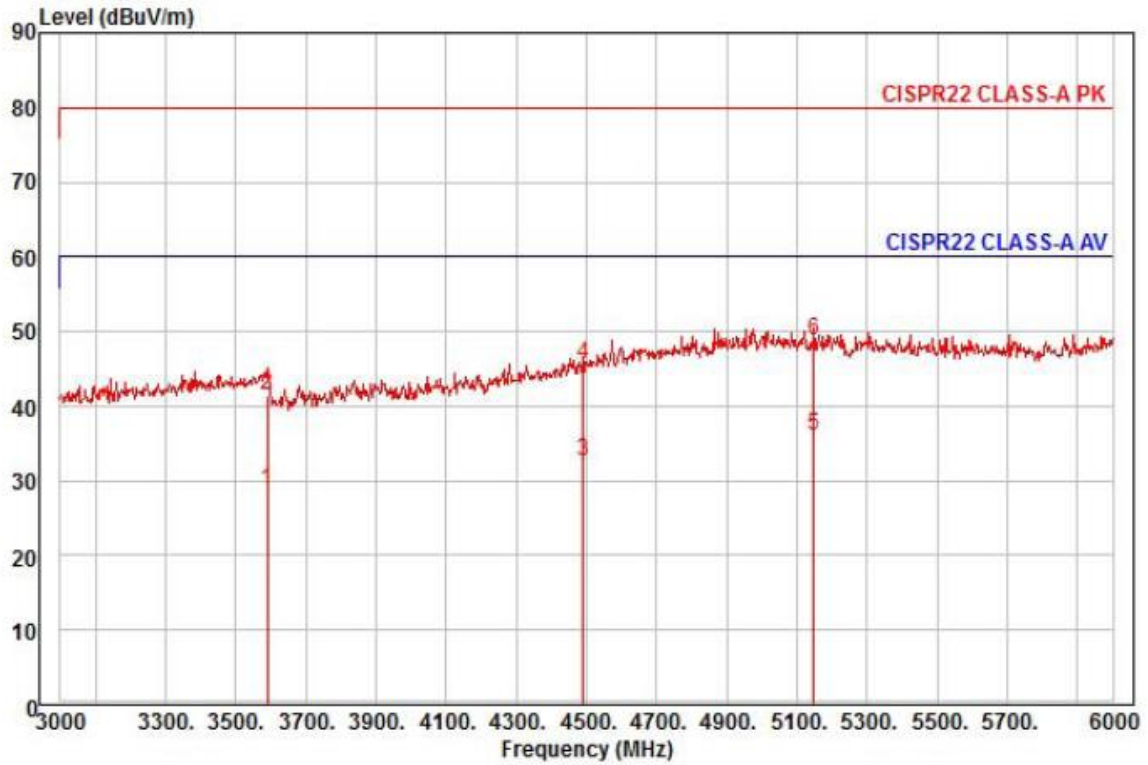

Site : chamber
 Condition: CISPR22 CLASS-A PK 3m HORN781(2015.05.07) horizontal
 : RBW:1000.000kHz VBW:1000.000kHz SWT:Auto
 Project :
 Model : XNV-6080RP
 Mode : AC 24 V
 Memo :

| | Read | Ant | Cable | Preamp | TPos | Limit | Over | | |
|------|---------|--------|-------|--------|-------|--------|-------|-----------|--------------------|
| Freq | Level | Factor | Loss | Factor | | Line | Limit | Pol/Phase | Remark |
| MHz | dBuV | dB/m | dB | dB | deg | dBuV/m | dB | | |
| 1 | 3591.00 | 25.32 | 31.32 | 12.79 | 40.85 | 66 | 60.00 | -31.42 | horizontal Average |
| 2 | 3591.00 | 38.09 | 31.32 | 12.79 | 40.85 | 66 | 80.00 | -38.65 | horizontal Peak |
| 3 | 4491.00 | 24.22 | 34.81 | 14.45 | 40.77 | 9 | 60.00 | -27.29 | horizontal Average |
| 4 | 4491.00 | 37.15 | 34.81 | 14.45 | 40.77 | 9 | 80.00 | -34.36 | horizontal Peak |
| 5 pp | 5148.00 | 23.47 | 37.42 | 15.61 | 40.52 | 219 | 60.00 | -24.02 | horizontal Average |
| 6 pk | 5148.00 | 36.17 | 37.42 | 15.61 | 40.52 | 219 | 80.00 | -31.32 | horizontal Peak |

◆ Calculation

$$\text{Over Limit [dB]} = (\text{Read Level[dBuV]} + \text{Ant Factor[dB/m]} + \text{Cable Loss [dB]} - \text{Preamp Factor [dB]}) - \text{Limit Line[dBuV]}$$

Over Limit : Margin Value, Read Level : Reading Value, Ant Factor : Ant Factor,
 Cable Loss : Cable loss, Preamp Factor : Preamp Factor

This report shall not be reproduced except in full, without the written approval of KES Co., Ltd.
 The results shown in this test report refer only to the sample(s) tested unless otherwise stated.

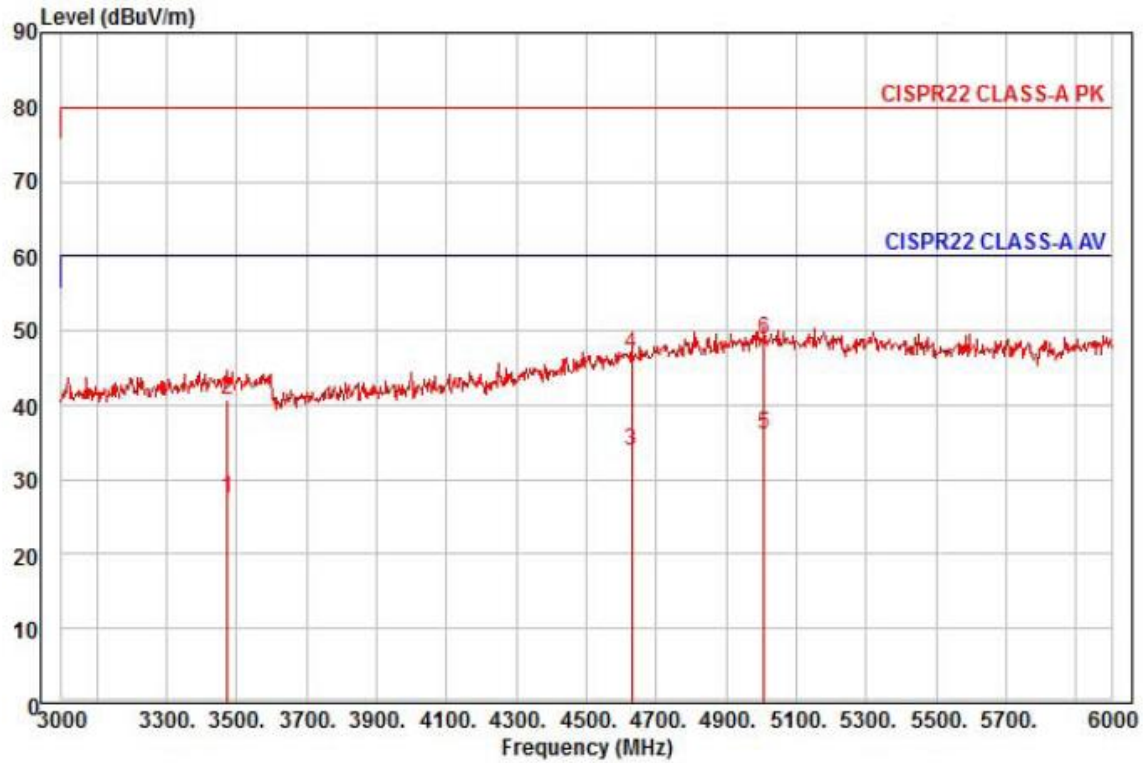

Site : chamber
 Condition: CISPR22 CLASS-A PK 3m HORN781(2015.05.07) vertical
 : RBW:1000.000kHz VBW:1000.000kHz SWT:Auto
 Project :
 Model : XNV-6080RP
 Mode : AC 24 V
 Memo :

| | Read Freq | Read Level | Ant Factor | Cable Loss | Preamp Factor | TPos | Limit Line | Over Limit | Pol/Phase | Remark |
|------|-----------|------------|------------|------------|---------------|------|------------|------------|-----------|---------|
| | MHz | dBuV | dB/m | dB | dB | deg | dBuV/m | dB | | |
| 1 | 3474.00 | 24.66 | 31.13 | 12.58 | 40.84 | 339 | 60.00 | -32.47 | vertical | Average |
| 2 | 3474.00 | 37.95 | 31.13 | 12.58 | 40.84 | 339 | 80.00 | -39.18 | vertical | Peak |
| 3 | 4629.00 | 24.17 | 35.60 | 14.72 | 40.64 | 61 | 60.00 | -26.15 | vertical | Average |
| 4 | 4629.00 | 37.16 | 35.60 | 14.72 | 40.64 | 61 | 80.00 | -33.16 | vertical | Peak |
| 5 pp | 5007.00 | 23.34 | 37.71 | 15.33 | 40.28 | 152 | 60.00 | -23.90 | vertical | Average |
| 6 pk | 5007.00 | 35.95 | 37.71 | 15.33 | 40.28 | 152 | 80.00 | -31.29 | vertical | Peak |

◆ Calculation

$$\text{Over Limit [dB]} = (\text{Read Level[dBuV]} + \text{Ant Factor[dB/m]} + \text{Cable Loss [dB]} - \text{Preamp Factor [dB]}) - \text{Limit Line[dBuV]}$$

Over Limit : Margin Value, Read Level : Reading Value, Ant Factor : Ant Factor,
 Cable Loss : Cable loss, Preamp Factor : Preamp Factor

This report shall not be reproduced except in full, without the written approval of KES Co., Ltd.
 The results shown in this test report refer only to the sample(s) tested unless otherwise stated.

- DC 12 V Mode

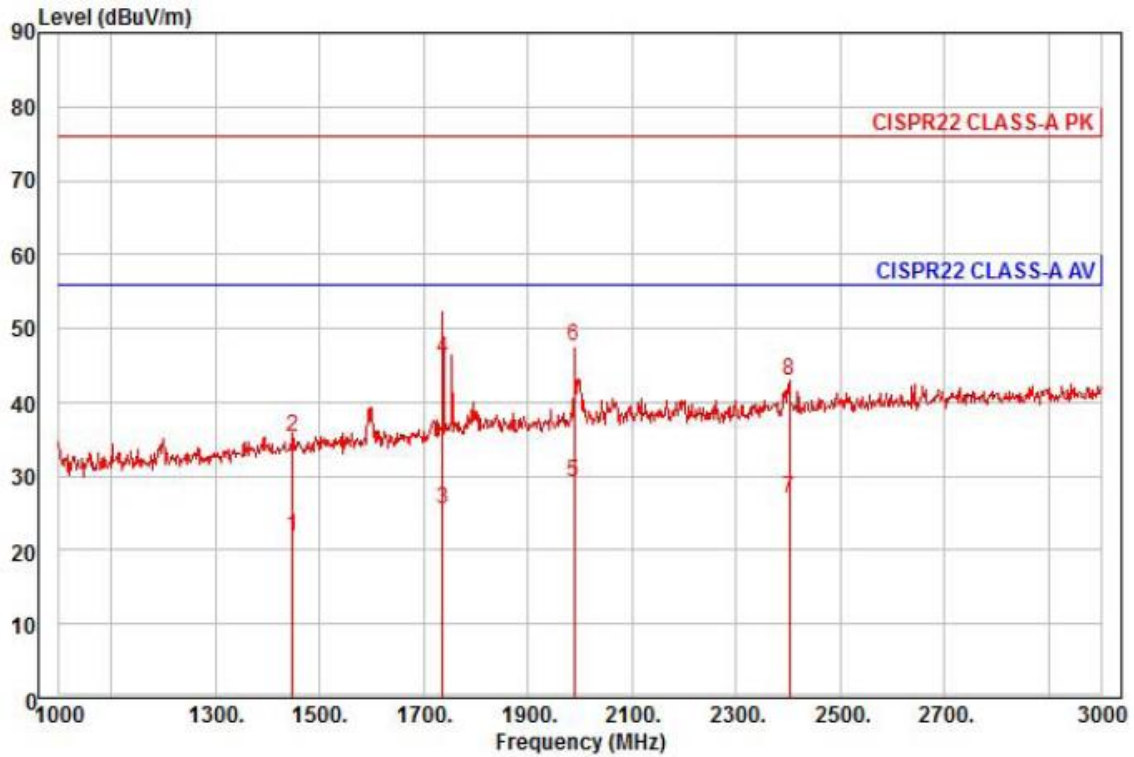

Site : chamber
 Condition: CISPR22 CLASS-A PK 3m HORN781(2015.05.07) horizontal
 : RBW:1000.000kHz VBW:1000.000kHz SWT:Auto
 Project :
 Model : XNV-6080RP
 Mode : DC 12 V
 Memo :

| | Freq | Read Level | Ant Factor | Cable Loss | Preamp Factor | TPos | Limit Line | Over Limit | Pol/Phase | Remark |
|------|---------|------------|------------|------------|---------------|------|------------|------------|------------|---------|
| | MHz | dBuV | dB/m | dB | dB | deg | dBuV/m | dB | | |
| 1 | 1448.00 | 27.43 | 25.69 | 7.86 | 39.15 | 283 | 56.00 | -34.17 | horizontal | Average |
| 2 | 1448.00 | 41.01 | 25.69 | 7.86 | 39.15 | 283 | 76.00 | -40.59 | horizontal | Peak |
| 3 | 1736.00 | 29.27 | 26.83 | 8.66 | 39.29 | 297 | 56.00 | -30.53 | horizontal | Average |
| 4 | 1736.00 | 49.61 | 26.83 | 8.66 | 39.29 | 297 | 76.00 | -30.19 | horizontal | Peak |
| 5 pp | 1988.00 | 31.41 | 27.83 | 9.31 | 39.40 | 160 | 56.00 | -26.85 | horizontal | Average |
| 6 pk | 1988.00 | 49.84 | 27.83 | 9.31 | 39.40 | 160 | 76.00 | -28.42 | horizontal | Peak |
| 7 | 2402.00 | 27.14 | 28.86 | 10.33 | 39.42 | 49 | 56.00 | -29.09 | horizontal | Average |
| 8 | 2402.00 | 43.18 | 28.86 | 10.33 | 39.42 | 49 | 76.00 | -33.05 | horizontal | Peak |

◆ Calculation

$$\text{Over Limit [dB]} = (\text{Read Level[dBuV]} + \text{Ant Factor[dB/m]} + \text{Cable Loss [dB]} - \text{Preamp Factor [dB]}) - \text{Limit Line[dBuV]}$$

Over Limit : Margin Value, Read Level : Reading Value, Ant Factor : Ant Factor,
 Cable Loss : Cable loss, Preamp Factor : Preamp Factor

This report shall not be reproduced except in full, without the written approval of KES Co., Ltd.
 The results shown in this test report refer only to the sample(s) tested unless otherwise stated.

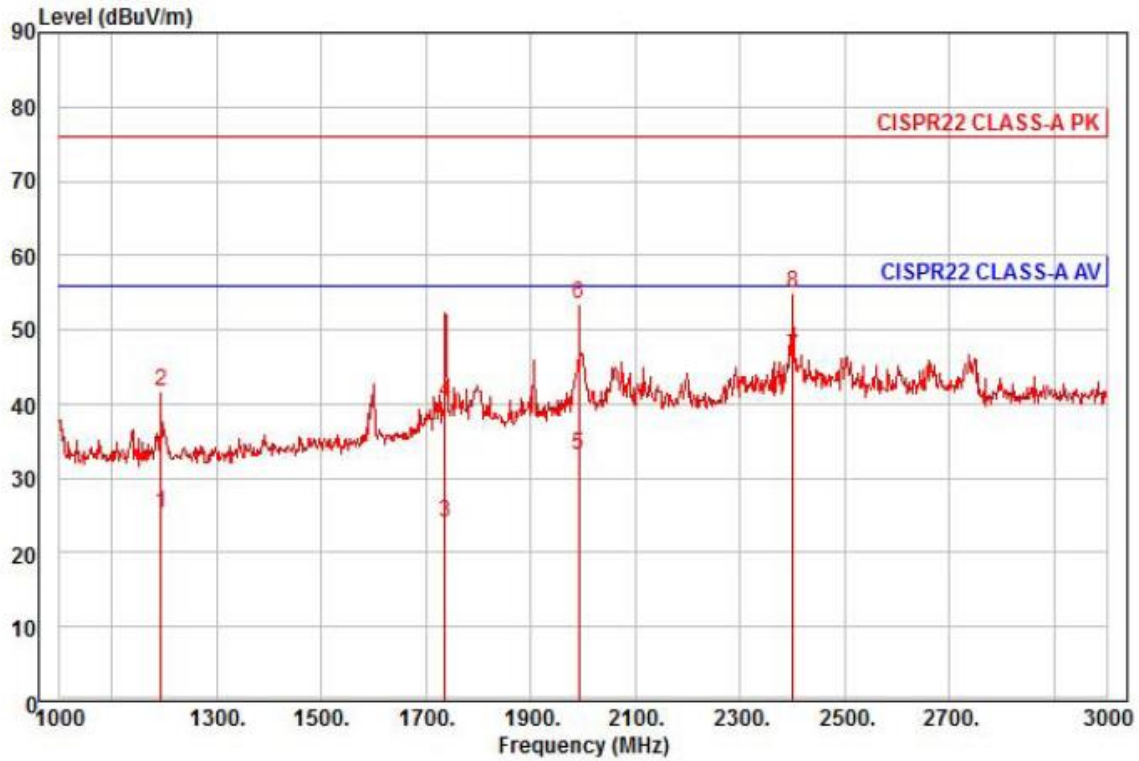

Site : chamber
 Condition: CISPR22 CLASS-A PK 3m HORN781(2015.05.07) vertical
 : RBW:1000.000kHz VBW:1000.000kHz SWT:Auto
 Project :
 Model : XNV-6080RP
 Mode : DC 12 V
 Memo :

| | Read Freq | Level | Ant Factor | Cable Loss | Preamp Factor | TPos | Limit Line | Over Limit | Pol/Phase | Remark |
|------|-----------|-------|------------|------------|---------------|------|------------|------------|-----------|---------|
| | MHz | dBuV | dB/m | dB | dB | deg | dBuV/m | dB | | |
| 1 | 1194.00 | 33.02 | 24.68 | 7.12 | 39.62 | 75 | 56.00 | -30.80 | vertical | Average |
| 2 | 1194.00 | 49.54 | 24.68 | 7.12 | 39.62 | 75 | 76.00 | -34.28 | vertical | Peak |
| 3 | 1736.00 | 27.90 | 26.83 | 8.66 | 39.29 | 37 | 56.00 | -31.90 | vertical | Average |
| 4 | 1736.00 | 44.03 | 26.83 | 8.66 | 39.29 | 37 | 76.00 | -35.77 | vertical | Peak |
| 5 | 1992.00 | 35.46 | 27.85 | 9.32 | 39.41 | 15 | 56.00 | -22.78 | vertical | Average |
| 6 | 1992.00 | 55.65 | 27.85 | 9.32 | 39.41 | 15 | 76.00 | -22.59 | vertical | Peak |
| 7 pp | 2400.00 | 46.51 | 28.86 | 10.32 | 39.42 | 349 | 56.00 | -9.73 | vertical | Average |
| 8 pk | 2400.00 | 55.29 | 28.86 | 10.32 | 39.42 | 349 | 76.00 | -20.95 | vertical | Peak |

◆ Calculation

$$\text{Over Limit [dB]} = (\text{Read Level[dBuV]} + \text{Ant Factor[dB/m]} + \text{Cable Loss [dB]} - \text{Preamp Factor [dB]}) - \text{Limit Line[dBuV]}$$

Over Limit : Margin Value, Read Level : Reading Value, Ant Factor : Ant Factor,
 Cable Loss : Cable loss, Preamp Factor : Preamp Factor

This report shall not be reproduced except in full, without the written approval of KES Co., Ltd.
 The results shown in this test report refer only to the sample(s) tested unless otherwise stated.

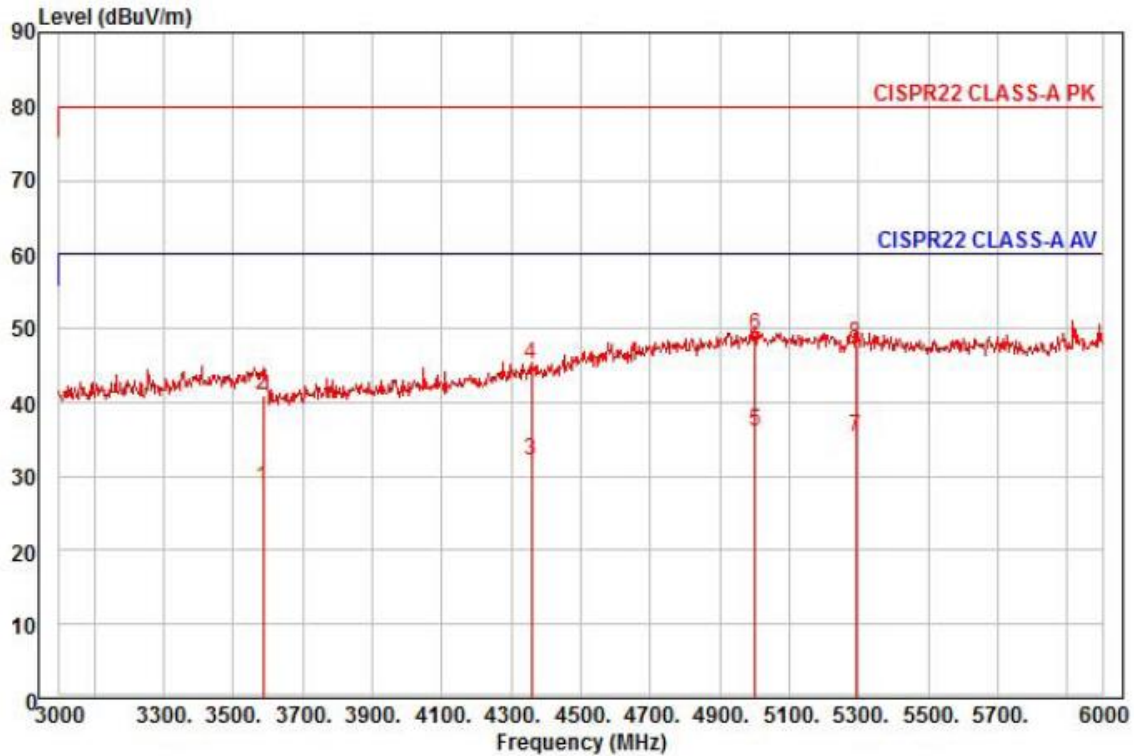

Site : chamber
 Condition: CISPR22 CLASS-A PK 3m HORN781(2015.05.07) horizontal
 : RBW:1000.000kHz VBW:1000.000kHz SWT:Auto
 Project :
 Model : XNV-6080RP
 Mode : DC 12 V
 Memo :

| | Freq | Read Level | Ant Factor | Cable Loss | Preamp Factor | TPos | Limit Line | Over Limit | Pol/Phase | Remark |
|------|---------|------------|------------|------------|---------------|------|------------|------------|------------|---------|
| | MHz | dBuV | dB/m | dB | dB | deg | dBuV/m | dB | | |
| 1 | 3585.00 | 25.24 | 31.31 | 12.78 | 40.85 | 314 | 60.00 | -31.52 | horizontal | Average |
| 2 | 3585.00 | 37.59 | 31.31 | 12.78 | 40.85 | 314 | 80.00 | -39.17 | horizontal | Peak |
| 3 | 4359.00 | 24.51 | 34.06 | 14.20 | 40.75 | 263 | 60.00 | -27.98 | horizontal | Average |
| 4 | 4359.00 | 37.67 | 34.06 | 14.20 | 40.75 | 263 | 80.00 | -34.82 | horizontal | Peak |
| 5 pp | 5001.00 | 23.39 | 37.72 | 15.32 | 40.27 | 180 | 60.00 | -23.84 | horizontal | Average |
| 6 pk | 5001.00 | 36.30 | 37.72 | 15.32 | 40.27 | 180 | 80.00 | -30.93 | horizontal | Peak |
| 7 | 5292.00 | 23.09 | 37.13 | 15.86 | 40.75 | 283 | 60.00 | -24.67 | horizontal | Average |
| 8 | 5292.00 | 35.63 | 37.13 | 15.86 | 40.75 | 283 | 80.00 | -32.13 | horizontal | Peak |

◆ Calculation

$$\text{Over Limit [dB]} = (\text{Read Level[dBuV]} + \text{Ant Factor[dB/m]} + \text{Cable Loss [dB]} - \text{Preamp Factor [dB]}) - \text{Limit Line[dBuV]}$$

Over Limit : Margin Value, Read Level : Reading Value, Ant Factor : Ant Factor,
 Cable Loss : Cable loss, Preamp Factor : Preamp Factor

This report shall not be reproduced except in full, without the written approval of KES Co., Ltd.
 The results shown in this test report refer only to the sample(s) tested unless otherwise stated.

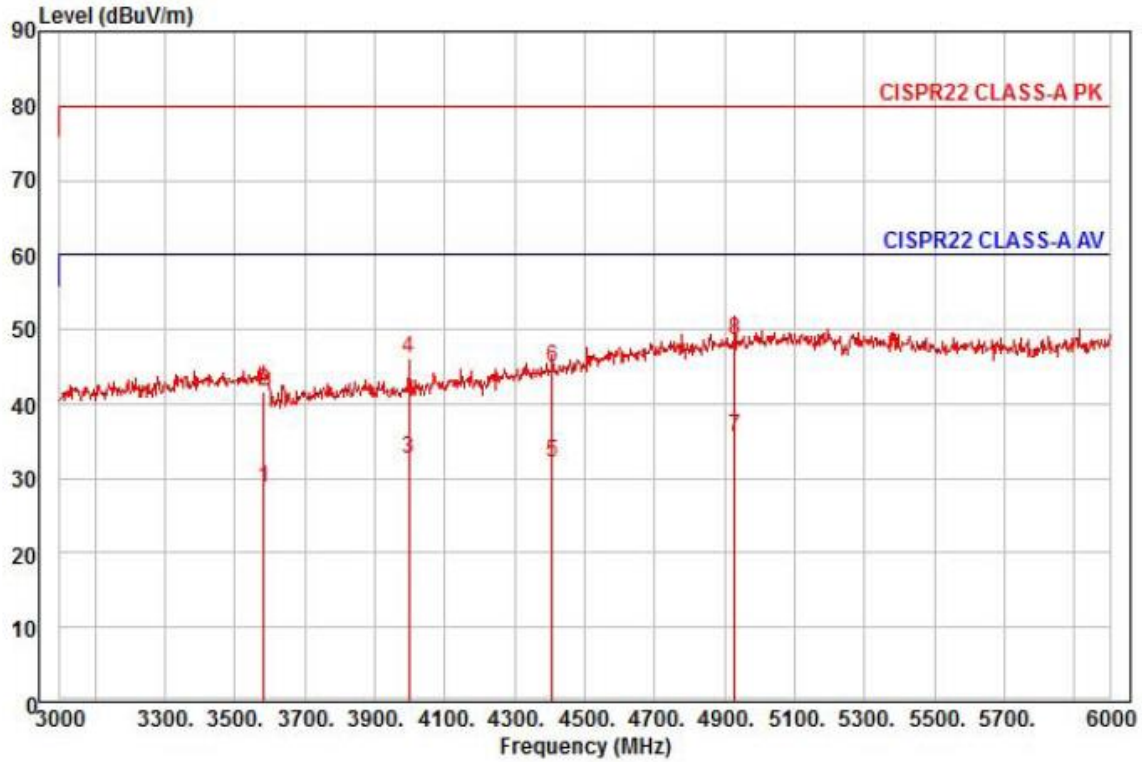

Site : chamber
 Condition: CISPR22 CLASS-A PK 3m HORN781(2015.05.07) vertical
 : RBW:1000.000kHz VBW:1000.000kHz SWT:Auto
 Project :
 Model : XNV-6080RP
 Mode : DC 12 V
 Memo :

| | Read Freq | Level | Ant Factor | Cable Loss | Preamp Factor | TPos | Limit Line | Over Limit | Pol/Phase | Remark |
|------|-----------|-------|------------|------------|---------------|------|------------|------------|-----------|---------|
| | MHz | dBuV | dB/m | dB | dB | deg | dBuV/m | dB | | |
| 1 | 3582.00 | 25.46 | 31.31 | 12.77 | 40.85 | 297 | 60.00 | -31.31 | vertical | Average |
| 2 | 3582.00 | 38.39 | 31.31 | 12.77 | 40.85 | 297 | 80.00 | -38.38 | vertical | Peak |
| 3 | 3999.00 | 27.77 | 32.01 | 13.56 | 40.70 | 354 | 60.00 | -27.36 | vertical | Average |
| 4 | 3999.00 | 41.19 | 32.01 | 13.56 | 40.70 | 354 | 80.00 | -33.94 | vertical | Peak |
| 5 | 4407.00 | 24.38 | 34.33 | 14.28 | 40.76 | 157 | 60.00 | -27.77 | vertical | Average |
| 6 | 4407.00 | 36.92 | 34.33 | 14.28 | 40.76 | 157 | 80.00 | -35.23 | vertical | Peak |
| 7 pp | 4929.00 | 23.41 | 37.31 | 15.24 | 40.34 | 121 | 60.00 | -24.38 | vertical | Average |
| 8 pk | 4929.00 | 36.44 | 37.31 | 15.24 | 40.34 | 121 | 80.00 | -31.35 | vertical | Peak |

◆ Calculation

$$\text{Over Limit [dB]} = (\text{Read Level[dBuV]} + \text{Ant Factor[dB/m]} + \text{Cable Loss [dB]} - \text{Preamp Factor [dB]}) - \text{Limit Line[dBuV]}$$

Over Limit : Margin Value, Read Level : Reading Value, Ant Factor : Ant Factor,
 Cable Loss : Cable loss, Preamp Factor : Preamp Factor

- PoE Mode

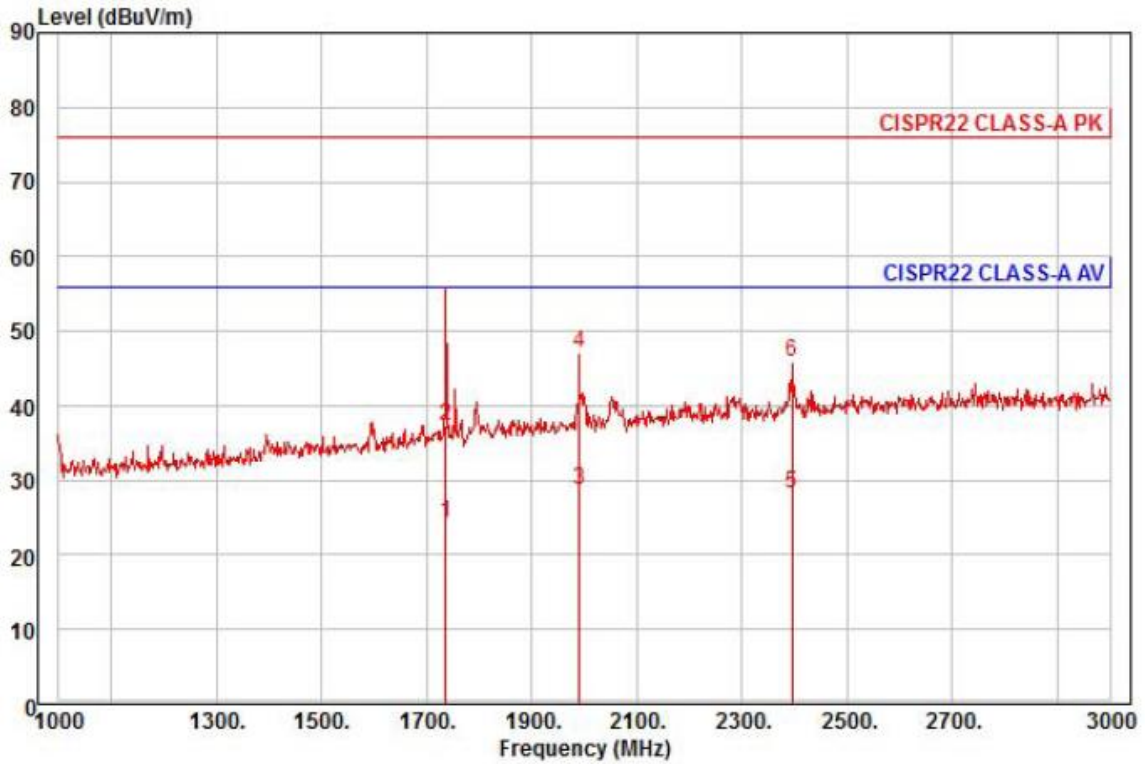

Site : chamber
 Condition: CISPR22 CLASS-A PK 3m HORN781(2015.05.07) horizontal
 : RBW:1000.000kHz VBW:1000.000kHz SWT:Auto
 Project :
 Model : XNV-6080RP
 Mode : POE
 Memo :

| | Read | Ant | Cable | Preamp | TPos | Limit | Over | | |
|------|---------|--------|-------|--------|------|--------|--------|------------|---------|
| Freq | Level | Factor | Loss | Factor | deg | Line | Limit | Pol/Phase | Remark |
| MHz | dBuV | dB/m | dB | dB | deg | dBuV/m | dB | | |
| 1 | 1736.00 | 28.03 | 26.83 | 8.66 | 352 | 56.00 | -31.77 | horizontal | Average |
| 2 | 1736.00 | 41.00 | 26.83 | 8.66 | 352 | 76.00 | -38.80 | horizontal | Peak |
| 3 pp | 1990.00 | 30.88 | 27.84 | 9.31 | 84 | 56.00 | -27.38 | horizontal | Average |
| 4 pk | 1990.00 | 49.27 | 27.84 | 9.31 | 84 | 76.00 | -28.99 | horizontal | Peak |
| 5 | 2396.00 | 28.58 | 28.85 | 10.31 | 55 | 56.00 | -27.68 | horizontal | Average |
| 6 | 2396.00 | 46.08 | 28.85 | 10.31 | 55 | 76.00 | -30.18 | horizontal | Peak |

◆ Calculation

Over Limit [dB] = (Read Level[dBuV] + Ant Factor[dB/m] + Cable Loss [dB] - Preamp Factor [dB]) - Limit Line[dBuV]

Over Limit : Margin Value, Read Level : Reading Value, Ant Factor : Ant Factor,
 Cable Loss : Cable loss, Preamp Factor : Preamp Factor

This report shall not be reproduced except in full, without the written approval of KES Co., Ltd.
 The results shown in this test report refer only to the sample(s) tested unless otherwise stated.

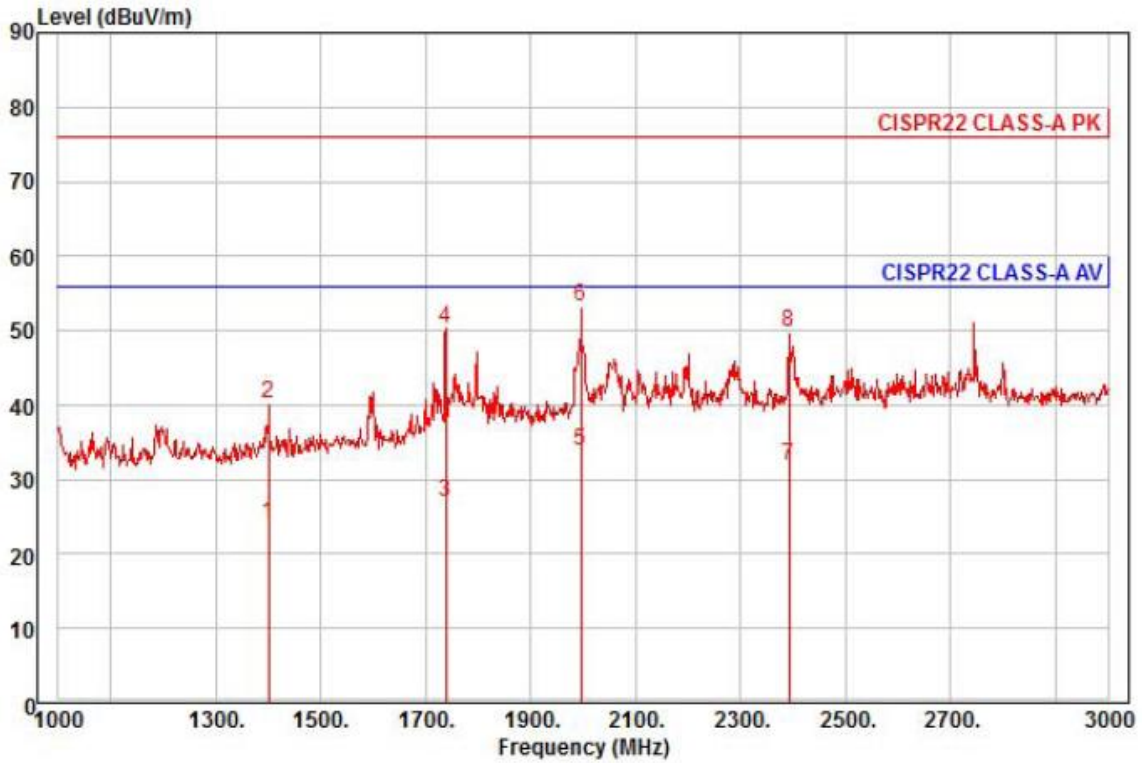

Site : chamber
 Condition: CISPR22 CLASS-A PK 3m HORN781(2015.05.07) vertical
 : RBW:1000.000kHz VBW:1000.000kHz SWT:Auto
 Project :
 Model : XNV-6080RP
 Mode : POE
 Memo :

| | Read Freq | Level | Ant Factor | Cable Loss | Preamp Factor | TPos | Limit Line | Over Limit | Pol/Phase | Remark |
|------|-----------|-------|------------|------------|---------------|------|------------|------------|-----------|---------|
| | MHz | dBuV | dB/m | dB | dB | deg | dBuV/m | dB | | |
| 1 | 1400.00 | 29.84 | 25.50 | 7.72 | 39.13 | 260 | 56.00 | -32.07 | vertical | Average |
| 2 | 1400.00 | 46.10 | 25.50 | 7.72 | 39.13 | 260 | 76.00 | -35.81 | vertical | Peak |
| 3 | 1738.00 | 30.64 | 26.84 | 8.67 | 39.29 | 163 | 56.00 | -29.14 | vertical | Average |
| 4 | 1738.00 | 54.05 | 26.84 | 8.67 | 39.29 | 163 | 76.00 | -25.73 | vertical | Peak |
| 5 pp | 1996.00 | 35.99 | 27.86 | 9.33 | 39.41 | 351 | 56.00 | -22.23 | vertical | Average |
| 6 pk | 1996.00 | 55.54 | 27.86 | 9.33 | 39.41 | 351 | 76.00 | -22.68 | vertical | Peak |
| 7 | 2392.00 | 32.17 | 28.84 | 10.30 | 39.42 | 48 | 56.00 | -24.11 | vertical | Average |
| 8 | 2392.00 | 50.12 | 28.84 | 10.30 | 39.42 | 48 | 76.00 | -26.16 | vertical | Peak |

◆ Calculation

$$\text{Over Limit [dB]} = (\text{Read Level [dBuV]} + \text{Ant Factor [dB/m]} + \text{Cable Loss [dB]} - \text{Preamp Factor [dB]}) - \text{Limit Line [dBuV]}$$

Over Limit : Margin Value, Read Level : Reading Value, Ant Factor : Ant Factor,
 Cable Loss : Cable loss, Preamp Factor : Preamp Factor

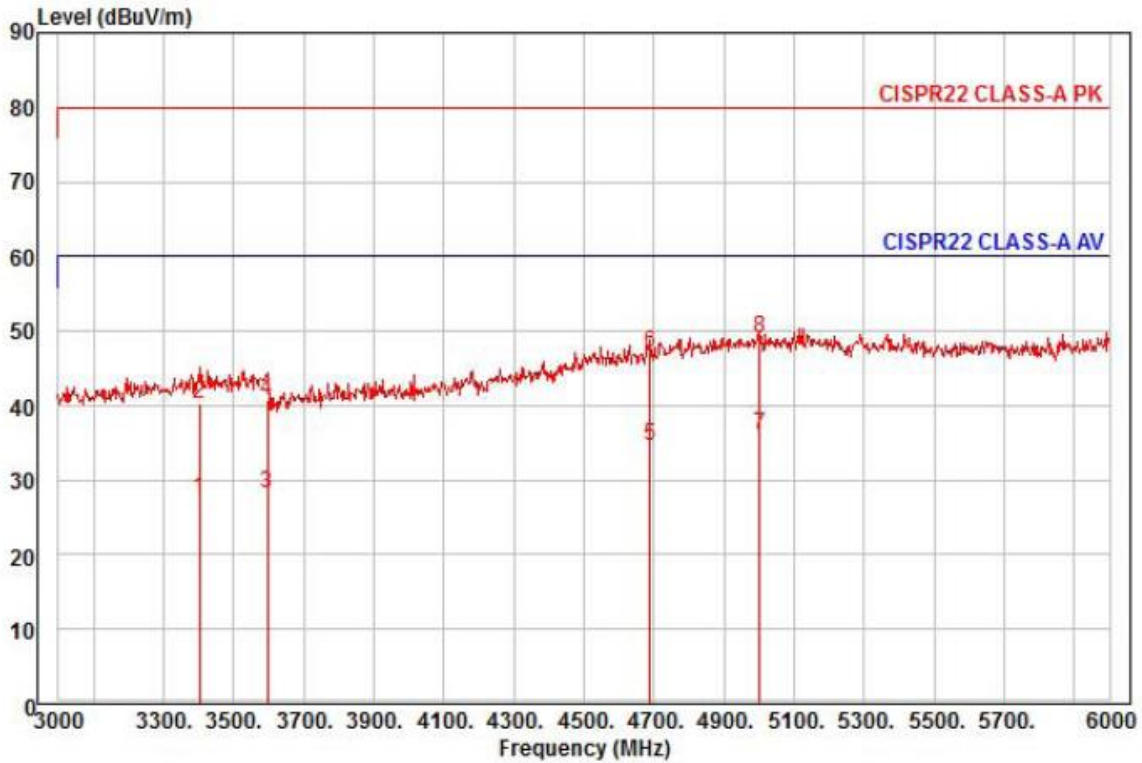

Site : chamber
 Condition: CISPR22 CLASS-A PK 3m HORN781(2015.05.07) horizontal
 : RBW:1000.000kHz VBW:1000.000kHz SWT:Auto
 Project :
 Model : XNV-6080RP
 Mode : POE
 Memo :

| | Freq | Read Level | Ant Factor | Cable Loss | Preamp Factor | TPos | Limit Line | Over Limit | Pol/Phase | Remark |
|------|---------|------------|------------|------------|---------------|------|------------|------------|------------|---------|
| | MHz | dBuV | dB/m | dB | dB | deg | dBuV/m | dB | | |
| 1 | 3402.00 | 24.74 | 31.01 | 12.45 | 40.73 | 101 | 60.00 | -32.53 | horizontal | Average |
| 2 | 3402.00 | 37.40 | 31.01 | 12.45 | 40.73 | 101 | 80.00 | -39.87 | horizontal | Peak |
| 3 | 3597.00 | 24.87 | 31.33 | 12.80 | 40.85 | 13 | 60.00 | -31.85 | horizontal | Average |
| 4 | 3597.00 | 37.55 | 31.33 | 12.80 | 40.85 | 13 | 80.00 | -39.17 | horizontal | Peak |
| 5 | 4689.00 | 24.34 | 35.94 | 14.85 | 40.58 | 266 | 60.00 | -25.45 | horizontal | Average |
| 6 | 4689.00 | 36.97 | 35.94 | 14.85 | 40.58 | 266 | 80.00 | -32.82 | horizontal | Peak |
| 7 pp | 5001.00 | 23.38 | 37.72 | 15.32 | 40.27 | 30 | 60.00 | -23.85 | horizontal | Average |
| 8 pk | 5001.00 | 36.17 | 37.72 | 15.32 | 40.27 | 30 | 80.00 | -31.06 | horizontal | Peak |

◆ Calculation

$$\text{Over Limit [dB]} = (\text{Read Level [dBuV]} + \text{Ant Factor [dB/m]} + \text{Cable Loss [dB]} - \text{Preamp Factor [dB]}) - \text{Limit Line [dBuV]}$$

Over Limit : Margin Value, Read Level : Reading Value, Ant Factor : Ant Factor,
 Cable Loss : Cable loss, Preamp Factor : Preamp Factor

This report shall not be reproduced except in full, without the written approval of KES Co., Ltd.
 The results shown in this test report refer only to the sample(s) tested unless otherwise stated.

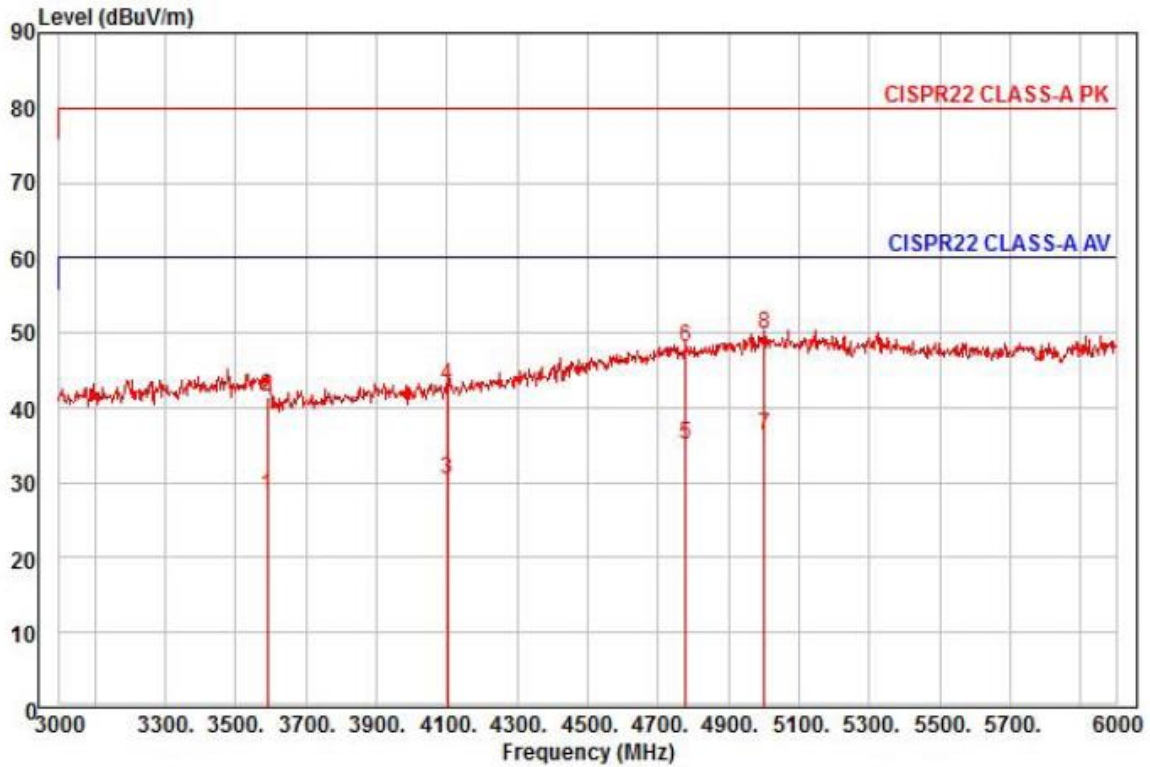

Site : chamber
 Condition: CISPR22 CLASS-A PK 3m HORN781(2015.05.07) vertical
 : RBW:1000.000kHz VBW:1000.000kHz SWT:Auto
 Project :
 Model : XNV-6080RP
 Mode : POE
 Memo :

| | Read | Ant | Cable | Preamp | TPos | Limit | Over | | | |
|------|---------|--------|-------|--------|-------|--------|-------|-----------|----------|---------|
| Freq | Level | Factor | Loss | Factor | | Line | Limit | Pol/Phase | Remark | |
| MHz | dBuV | dB/m | dB | dB | deg | dBuV/m | dB | | | |
| 1 | 3591.00 | 24.98 | 31.32 | 12.79 | 40.85 | 277 | 60.00 | -31.76 | vertical | Average |
| 2 | 3591.00 | 38.29 | 31.32 | 12.79 | 40.85 | 277 | 80.00 | -38.45 | vertical | Peak |
| 3 | 4101.00 | 24.72 | 32.59 | 13.75 | 40.71 | 114 | 60.00 | -29.65 | vertical | Average |
| 4 | 4101.00 | 37.37 | 32.59 | 13.75 | 40.71 | 114 | 80.00 | -37.00 | vertical | Peak |
| 5 | 4779.00 | 24.12 | 36.46 | 15.05 | 40.49 | 9 | 60.00 | -24.86 | vertical | Average |
| 6 | 4779.00 | 37.08 | 36.46 | 15.05 | 40.49 | 9 | 80.00 | -31.90 | vertical | Peak |
| 7 pp | 5001.00 | 23.40 | 37.72 | 15.32 | 40.27 | 134 | 60.00 | -23.83 | vertical | Average |
| 8 pk | 5001.00 | 36.89 | 37.72 | 15.32 | 40.27 | 134 | 80.00 | -30.34 | vertical | Peak |

◆ Calculation

$$\text{Over Limit [dB]} = (\text{Read Level[dBuV]} + \text{Ant Factor[dB/m]} + \text{Cable Loss [dB]} - \text{Preamp Factor [dB]}) - \text{Limit Line[dBuV]}$$

Over Limit : Margin Value, Read Level : Reading Value, Ant Factor : Ant Factor,
 Cable Loss : Cable loss, Preamp Factor : Preamp Factor

This report shall not be reproduced except in full, without the written approval of KES Co., Ltd.
 The results shown in this test report refer only to the sample(s) tested unless otherwise stated.



Harmonic Current Emissions and Voltage Fluctuations and Flicker

Average harmonic current results

| Hn | I _{eff} [A] | % of Limit | Limit [A] | Result |
|-----|----------------------|------------|-----------|--------|
| N/A | | | | |

Harmonic currents less than 0.6% of the input current measured under the test conditions, or less than 5 mA, whichever is greater, are disregarded.

This report shall not be reproduced except in full, without the written approval of KES Co., Ltd.
The results shown in this test report refer only to the sample(s) tested unless otherwise stated.

Test Data - Harmonics (continued)

Maximum harmonic current results

| Hn | I _{eff} [A] | % of Limit | Limit [A] | Result |
|-----|----------------------|------------|-----------|--------|
| N/A | | | | |
| | | | | |

Harmonic currents less than 0.6% of the input current measured under the test conditions, or less than 5 mA, whichever is greater, are disregarded.

This report shall not be reproduced except in full, without the written approval of KES Co., Ltd.
 The results shown in this test report refer only to the sample(s) tested unless otherwise stated.



Test Data - Voltage Fluctuations

Maximum Flicker results

| | EUT values | Limit | Result |
|----------|-------------------|--------------|---------------|
| Pst | N/A | | |
| Plt | | | |
| dc [%] | | | |
| dmax [%] | | | |
| Tmax [s] | | | |

This report shall not be reproduced except in full, without the written approval of KES Co., Ltd.
The results shown in this test report refer only to the sample(s) tested unless otherwise stated.

Test Setup Photos and Configuration

Conducted Voltage Emissions

- AC 24 V Mode



This report shall not be reproduced except in full, without the written approval of KES Co., Ltd.
The results shown in this test report refer only to the sample(s) tested unless otherwise stated.

Conducted Telecommunication Emissions

- AC 24 V Mode



This report shall not be reproduced except in full, without the written approval of KES Co., Ltd.
The results shown in this test report refer only to the sample(s) tested unless otherwise stated.

- DC 12 V Mode

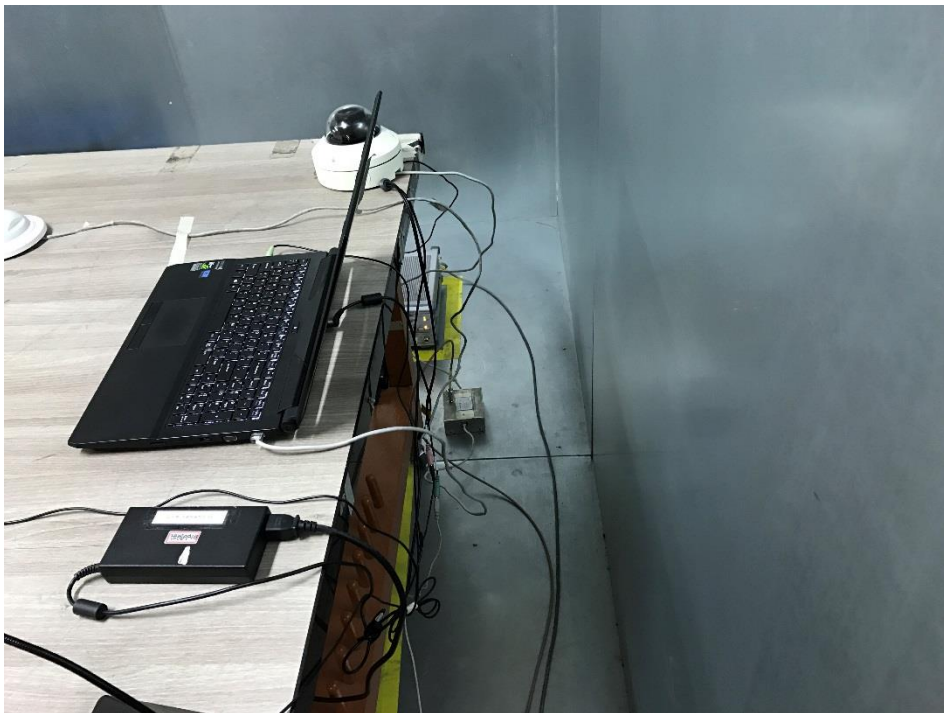

This report shall not be reproduced except in full, without the written approval of KES Co., Ltd.
The results shown in this test report refer only to the sample(s) tested unless otherwise stated.

- PoE Mode

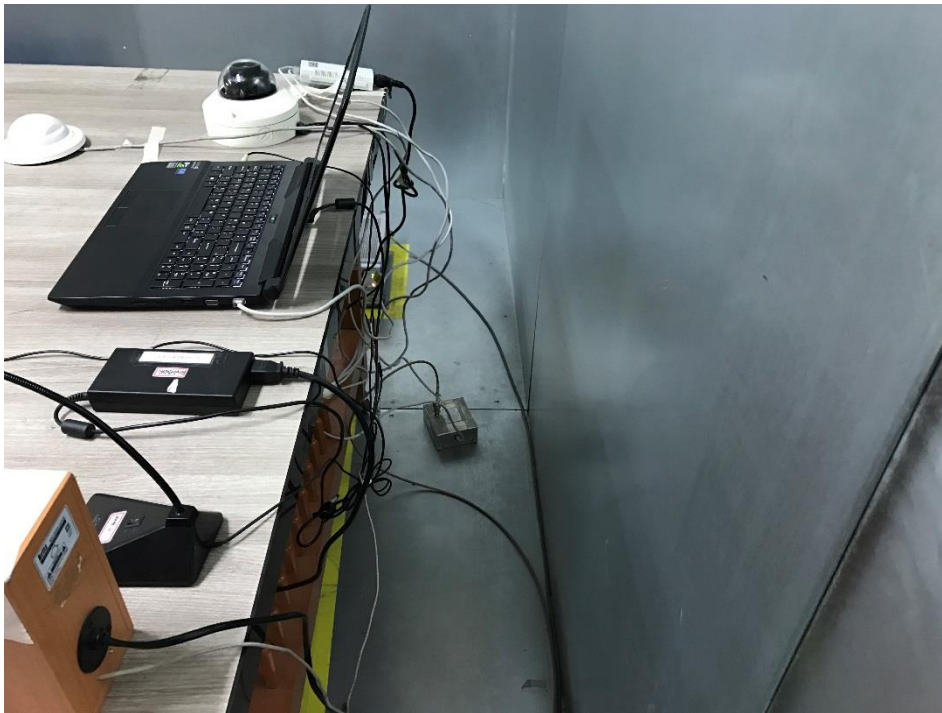

This report shall not be reproduced except in full, without the written approval of KES Co., Ltd.
The results shown in this test report refer only to the sample(s) tested unless otherwise stated.

Radiated Electric Field Emissions(Below 1 GHz)

- AC 24 V Mode



This report shall not be reproduced except in full, without the written approval of KES Co., Ltd.
The results shown in this test report refer only to the sample(s) tested unless otherwise stated.

- DC 12 V Mode



This report shall not be reproduced except in full, without the written approval of KES Co., Ltd.
The results shown in this test report refer only to the sample(s) tested unless otherwise stated.

- PoE Mode

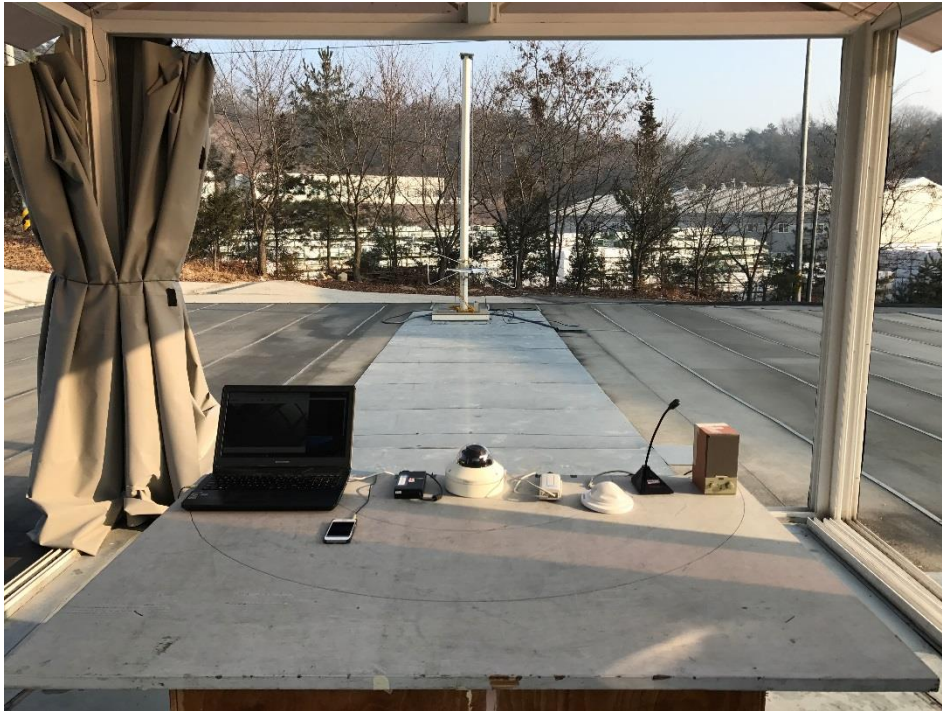

This report shall not be reproduced except in full, without the written approval of KES Co., Ltd.
The results shown in this test report refer only to the sample(s) tested unless otherwise stated.

Radiated Electric Field Emissions(Above 1 GHz)

- AC 24 V Mode



This report shall not be reproduced except in full, without the written approval of KES Co., Ltd.
The results shown in this test report refer only to the sample(s) tested unless otherwise stated.

- DC 12 V Mode

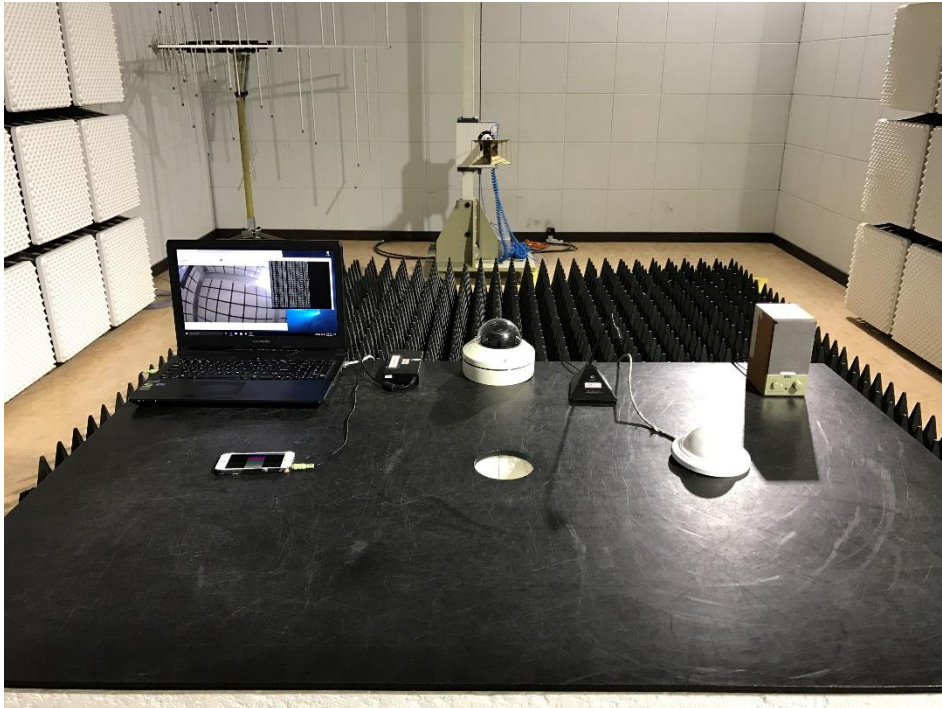

This report shall not be reproduced except in full, without the written approval of KES Co., Ltd.
The results shown in this test report refer only to the sample(s) tested unless otherwise stated.

- PoE Mode

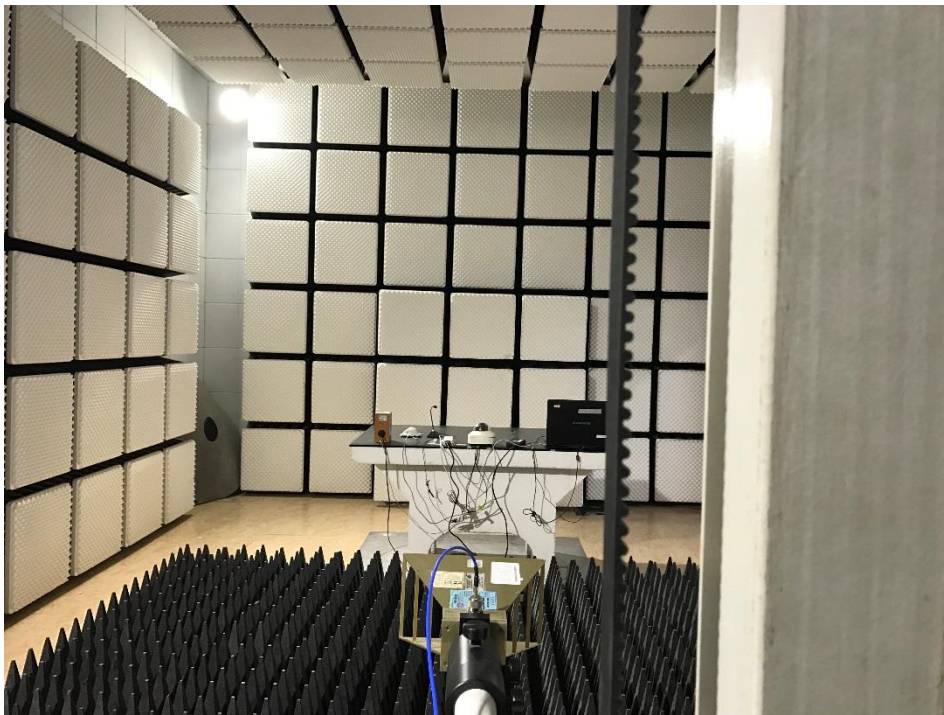

This report shall not be reproduced except in full, without the written approval of KES Co., Ltd.
The results shown in this test report refer only to the sample(s) tested unless otherwise stated.



KES Co., Ltd.

C-3701, Simin-daero 365-40,
Dongan-gu, Anyang-si, Gyeonggi-do, 14057, Korea
Tel: +82-31-425-6200 / Fax: +82-31-424-0450
www.kes.co.kr

Test report No.:
KES-E1-16T0673
Page (78) of (98)

Harmonic Current Emissions and Voltage Fluctuations and Flicker

N/A

This report shall not be reproduced except in full, without the written approval of KES Co., Ltd.
The results shown in this test report refer only to the sample(s) tested unless otherwise stated.

Electrostatic Discharge

- AC 24 V Mode



- DC 12 V Mode

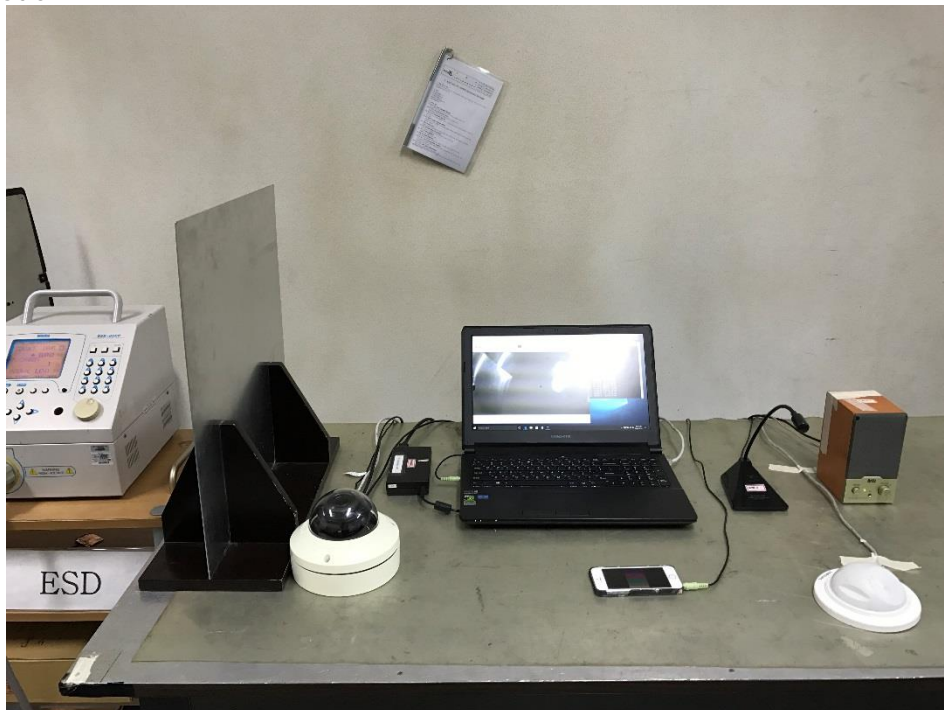

This report shall not be reproduced except in full, without the written approval of KES Co., Ltd.
The results shown in this test report refer only to the sample(s) tested unless otherwise stated.

- PoE Mode



This report shall not be reproduced except in full, without the written approval of KES Co., Ltd.
The results shown in this test report refer only to the sample(s) tested unless otherwise stated.

Radiated Electric Field Immunity

- AC 24 V Mode



- DC 12 V Mode

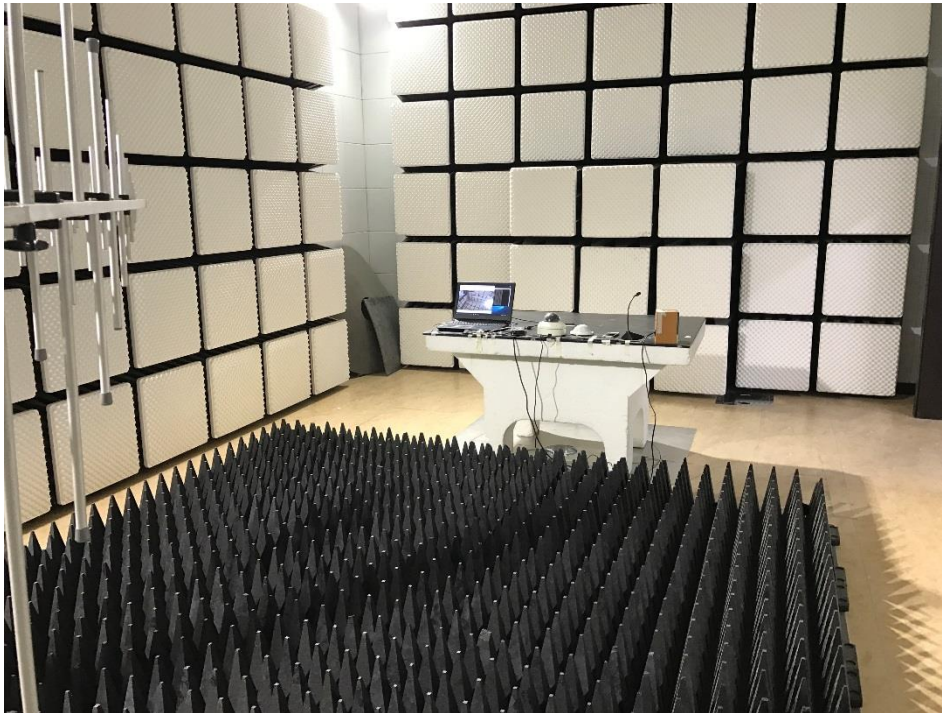

This report shall not be reproduced except in full, without the written approval of KES Co., Ltd.
The results shown in this test report refer only to the sample(s) tested unless otherwise stated.

- PoE Mode



This report shall not be reproduced except in full, without the written approval of KES Co., Ltd.
The results shown in this test report refer only to the sample(s) tested unless otherwise stated.

Electrical Fast Transients/Bursts

- AC 24 V Mode



This report shall not be reproduced except in full, without the written approval of KES Co., Ltd.
The results shown in this test report refer only to the sample(s) tested unless otherwise stated.

- DC 12 V Mode



This report shall not be reproduced except in full, without the written approval of KES Co., Ltd.
The results shown in this test report refer only to the sample(s) tested unless otherwise stated.

- PoE Mode

N/A



This report shall not be reproduced except in full, without the written approval of KES Co., Ltd.
The results shown in this test report refer only to the sample(s) tested unless otherwise stated.

Surge Transients

- AC 24 V Mode



- DC 12 V Mode



This report shall not be reproduced except in full, without the written approval of KES Co., Ltd.
The results shown in this test report refer only to the sample(s) tested unless otherwise stated.

- PoE Mode



This report shall not be reproduced except in full, without the written approval of KES Co., Ltd.
The results shown in this test report refer only to the sample(s) tested unless otherwise stated.

Conducted Disturbance

- AC 24 V Mode



This report shall not be reproduced except in full, without the written approval of KES Co., Ltd.
The results shown in this test report refer only to the sample(s) tested unless otherwise stated.

- DC 12 V Mode

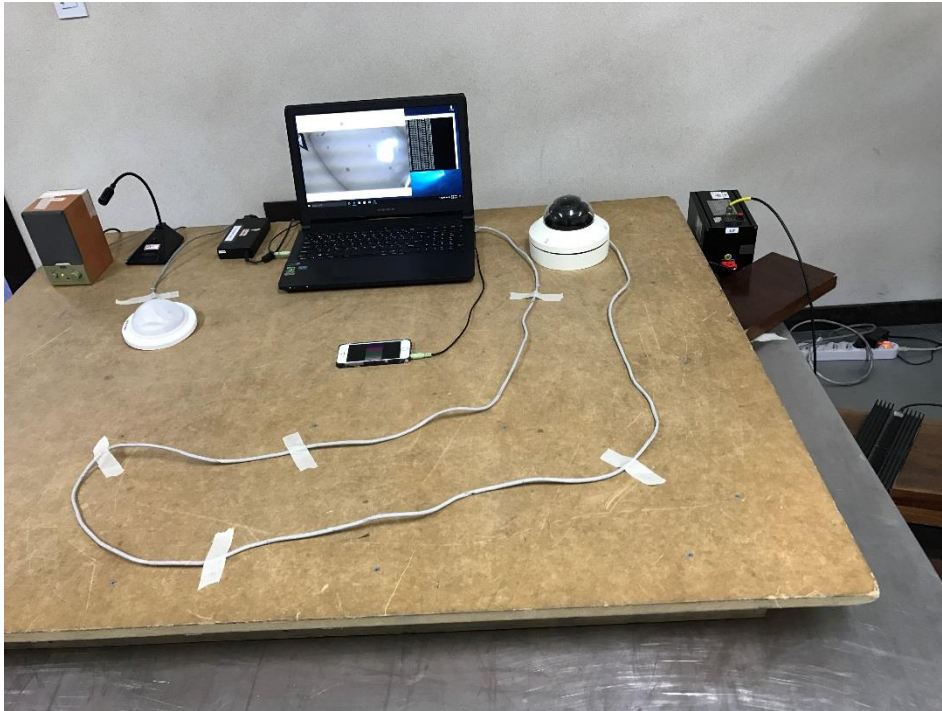

This report shall not be reproduced except in full, without the written approval of KES Co., Ltd.
The results shown in this test report refer only to the sample(s) tested unless otherwise stated.

- PoE Mode

N/A



This report shall not be reproduced except in full, without the written approval of KES Co., Ltd.
The results shown in this test report refer only to the sample(s) tested unless otherwise stated.

Voltage Dips and Short Interruptions

- AC 24 V Mode



This report shall not be reproduced except in full, without the written approval of KES Co., Ltd.
The results shown in this test report refer only to the sample(s) tested unless otherwise stated.

EUT External Photographs

(Top)



(Bottom)



This report shall not be reproduced except in full, without the written approval of KES Co., Ltd.
The results shown in this test report refer only to the sample(s) tested unless otherwise stated.

EUT Internal Photographs

(Internal View)



This report shall not be reproduced except in full, without the written approval of KES Co., Ltd.
The results shown in this test report refer only to the sample(s) tested unless otherwise stated.

EUT Internal View – Lens

(Top)



(Bottom)



This report shall not be reproduced except in full, without the written approval of KES Co., Ltd.
The results shown in this test report refer only to the sample(s) tested unless otherwise stated.

EUT Internal View – Board 1

(Top)

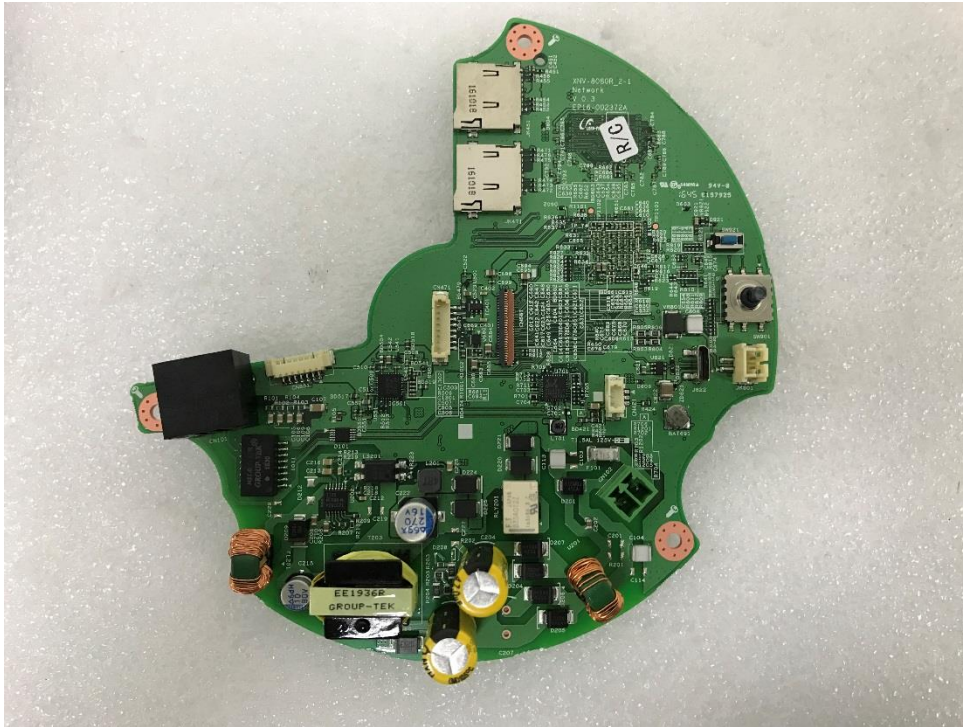

(Bottom)

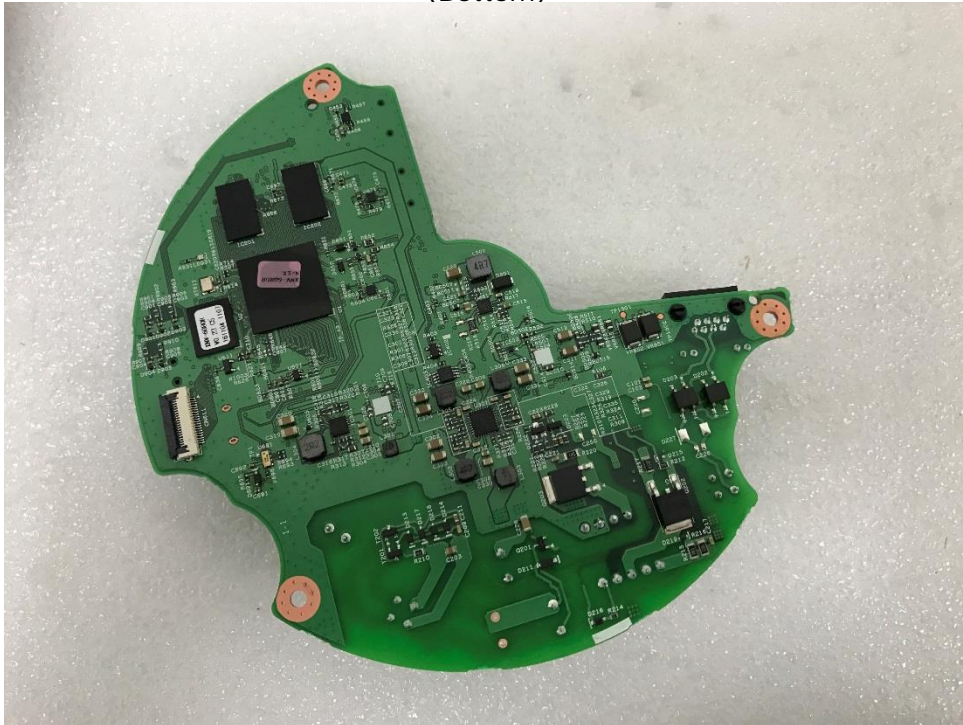

This report shall not be reproduced except in full, without the written approval of KES Co., Ltd.
The results shown in this test report refer only to the sample(s) tested unless otherwise stated.

EUT Internal View – Board 2

(Top)



(Bottom)



This report shall not be reproduced except in full, without the written approval of KES Co., Ltd.
The results shown in this test report refer only to the sample(s) tested unless otherwise stated.

EUT Internal View – Board 3

(Top)



(Bottom)



This report shall not be reproduced except in full, without the written approval of KES Co., Ltd.
The results shown in this test report refer only to the sample(s) tested unless otherwise stated.

Label and Location



NETWORK CAMERA

Model No : XNV-6080RP

Manufacturer : Hanwha Techwin (Tianjin) Co.,Ltd.

Made in of China

